

# PHYSICAL EDUCATION AND SPORTS

CLASS-XI



**Punjab School Education Board**

Sahibzada Ajit Singh Nagar

© Punjab Government

**Edition : 2018 : ..... Copies**

[This book has been adopted with the kind permission of the National Council of Educational Research and Training, New Delhi]

All rights, including those of translation, reproduction and annotation etc., are reserved by the Punjab Government

**CO-ORDINATOR**

**S. Harjinder Pal Singh**  
Subject Expert P.S.E.B.

**CHIEF VETTER**

**Dr. Kalsi (Associate Professor)**  
**Sahid Kanshi Ram College of Physical Education Bhagu Majra (Mohali)**

**VETTER**

**Sh. Tarun Bharti**  
English Master

**WARNING**

1. The Agency-holders shall not add any extra binding with a view to charge extra money for the binding. (Ref. Cl. No. 7 of agreement with Agency-holders).
2. Printing, Publishing, Stocking, Holding or Selling etc., of spurious Text-books qua text-books printed and published by the Punjab School Education Board is a cognizable offence under Indian Penal Code.

**Price : Rs.**

---

Published by : **Secretary** Punjab School Education Board, Vidya Bhavan Phase-8 Sahibzada Ajit Singh Nagar-160062 & Printed by

**CLASS-XI**

**PHYSICAL EDUCATION AND SPORTS**

**Time : 3 Hours**

**Theory Max Marks : 50**

**Practical :40**

**CCE : 10**

**Total :100**

**Structure OF Questions Paper (Theory)**

1. There will be 23 questions in all. All questions are compulsory.
2. Question Nos. 1 to 10 carry one mark each. These can also be objective type. **10x1 = 10 marks**
3. Question Nos. 11 to 15 carry two marks each. Answer should be approximately. 20 words. **5x2 =10 marks**
4. Questions Nos. 16 to 20 carry 3 marks each. Answer should be 30 to 50 marks. **5x3 = 15 marks**
5. Questions Nos. 21 to 23 carry 5 marks each. There will be 5 questions in this part, attempt only 3 questions. **3x5 = 15 marks**

**SYLLABUS**

**Lesson 1. Health Education**

(a) Definition of health (b) Types (c) Objective (d) Principles  
(e) Measures (f) Scope

**Lesson 2. Physical Education and Its Importance**

(a) Aims and objective of Physical Education (b) Scope  
(c) Importance

**Lesson 3. Introduction to Anatomy and Physiology**

(a) Introduction of Anatomy and Physiology (b) Contribution of  
Anatomy and Physiology in the field of Physical education and  
Sports

**Lesson 4. Yoga**

(a) Definition (b) History (c) Meaning (d) Importance (e) Surya  
Namaskar (e) Ashtang Yoga

**Lesson 5. Harmful effects of Doping and drugs**

(a) Types of Drugs (b) Causes of Drugs Addiction (c) Effects of

Drugs on Players, Family, society and nation (d) Meaning of Doping (e) International Olympic Committee

**Lesson 6. Sports Psychology**

(a) Meaning (b) Definition (c) Scope (d) Branches (e) Psychology facts (f) Inspiration

**Lesson7. Tournament**

(a) Types of Tournament (b) Methods of Fixture (c) Advantages and Disadvantages of the league tournament and Knock out Tournament.

**PRACTICALS**

**Time : 4 Hrs.**

**Max. Marks : 40**

**(A) Track and Field Events (Common for Boys and Girls)**

Any two events be opted. Each event will carry 6 marks.

1. Sprints – 100 m. 200 m. 400 m. 800 m. 3000 m.
2. 110 m Hurdles for boys (hurdle should be 96.4 cm high and ten heights) 100 m hurdle for girls (Hurdle should be 76.2 cm high and eight heights) 4x100 m (for boys), 4x100 m (for girls) relay
3. Hammer throw , Discus Throw , Javelin Throw, Shot-put, Long Jump, High Jump, Triple Jump, Pole Vault.

**(B) Any two games can be opted from the following. Each game will carry 6 marks.**

Games (for boys and girls)

Group 1. Handball, kabaddi, Boxing, Table Tennis, Gymnastic, Football,

Group 2. Volleyball, Gattka, Basketball, Yogic Physical exercises, Circle Kabaddi

**(C) Achievements in sports (Maximum 10 marks) as listed below :**

School Representation 2 Marks

Zonal Representation 4 Marks

Distt. Representation 6 marks

State Representation 8 Marks

National Representation 10 marks

(D) Practical Copy, chart or Modal 3 Marks

(E) Viva Voce 5 Marks

**Notes : At the time of practical the students must be in sports Kit.**

## CONTENTS

### PART-I (THEORY)

Lesson 1	Health Education	1-10
Lesson 2	Physical Education And Its Importance	11-19
Lesson 3	Introduction to Anatomy And Physiology	20-35
Lesson 4	Yoga	36-49
Lesson 5	Harmful Effects of Doping And Drugs	50-61
Lesson 6	Sports Psychology	62-74
Lesson 7	Tournament	75-99

### PART-II (PRACTICAL)

<b>Practical</b>	<b>100</b>
1. Yog	101-107
2. Volleyball	108-113
3. Athletics	114-133
4. Table Tennis	134-139
5. Handball	140-148
6. Football	149-156
7. Kabaddi	157-163
8. Circle Style Kabaddi	164-169
9. Boxing	170-178
10. Basketball	179-190
11. Gymnastics	191-198
12. Gatka	199-202

<b>WRITER</b>	<b>LESSON</b>
1. <b>S. Kuldip Singh Banur</b> <b>Lecturer Phy. Edu.</b>	1. Health Education (Theory) 2. Athletics (Practical) 3. Volleyball (Practical) 4. Football (Practical) 5. Table Tennis (Practical) 6. Gatka (Practical)
2. <b>S. Harpal Singh</b> <b>Lecturer Phy. Edu.</b>	1. Physical Education And Its Importance (Theory)
3. <b>Smt. Mandeep Kaur Brar</b> <b>Lecturer Phy. Edu.</b>	1. Introduction to Anatomy And Physiology (Theory) 2. Sports Psychology (Theory) 3. Handball (Practical)
4. <b>Smt. Renu Kaushal</b> <b>Lecturer Phy. Edu.</b>	1. Yog (Theory) 2. Gymnastics (Practical) 3. Yog (Practical)
5. <b>S. Paramjit Singh</b> <b>Lecturer Phy. Edu.</b>	1. Harmful Effects of Doping And Drugs (Theory) 2. Boxing (Practical) 3. Basketball (Practical)
6. <b>Smt. Paramvir Kaur</b> <b>Lecturer Phy. Edu.</b>	1. Tournament (Theory) 2. Kabaddi (Practical) 3. Circle Style Kabaddi (Practical)

## LESSON - 1

# HEALTH EDUCATION

Generally, an obese body is considered as healthy, but in reality, it is not so. According to WHO (World Health Organisation), the word health is not just confined to physical health rather it is associated with mental and emotional health also. A body of a healthy person is capable of managing internal organs in the best way and is able to adapt as per the external environment. Modern health education is making efforts to enhance the work efficiency of a human body for fitness of various body organs.

Though several scholars have put forth different views about health, yet the education to keep one's body healthy is imparted by a teacher to his students is also health education; the awareness campaign carried out by a doctor to save his patients from disease is health education; the attempt made by an individual to maintain the efficiency and fitness level of one's body is health education. An effort made by an ordinary person to save himself from ailment is health education; It is very hard to pen-down the concept of health education in single definition. To define health, it is a must for an individual to go through few definitions.

In 1984, WHO defined the word health in the following words "Health is a dynamic state of complete physical, mental, social and spiritual well-being and not merely the absence of disease or infirmity."

According to Oxford Dictionary, "Health refers to a disease-free body and mind". It is such a condition in which the work of body and mind is accomplished in the best way.

In the words of John Locke “A sound mind lives in a sound body”.

As per the Encyclopedia of health, “It is such a condition in which man is capable of bringing his daily life into action with the help of his intellectual and emotional traits”.

### **KINDS OF HEALTH**

**According to World Health Organisation (WHO) health is of Four types :**

1. Physical Health.
2. Mental Health.
3. Social Health.
4. Spiritual Health.

### **PHYSICAL HEALTH**

Physical health refers to that body which is fit and fine, energetic, active and ready to do physical activities. All systems of a healthy body like respiratory system, blood circulatory system and senses perform their respective jobs properly.

### **MENTAL HEALTH**

It refers to the balancing of human behaviour. It is an important aspect of health because as per this aspect, man does not let any situation overpower him under any circumstances. A mentally healthy person always adapts according to the situation. He does not let mental burden overpower him. He does not get over excited in happiness nor does he get shattered in sorrow. He faces a favourable or adverse situation with self-confidence. A mentally healthy person is able to tackle and overcome all the obstacles or adversities in his way.



## **SOCIAL HEALTH**

Man is a social being. Every person struggles to have a reputed position in society. The recognition of a person in society depends on his social contacts or relations. Gradually he makes his own identity with his activities and intellectual capacity. He makes efforts to maintain his social contact in the society by obeying the social norms. If a person does not have on good terms with the society, he has to face many difficulties.

## **SPIRITUAL HEALTH**

It is a general belief that spiritual health promotes mental comfort in man. Mental peace saves one from physical problems. Religious practices and rituals strengthen one's faith. Such religious practices calm the mind of a person.

## **OBJECTIVES OF HEALTH**

### **1. PHYSICAL DEVELOPMENT**

The foremost aspect of health is related with physical fitness. If an individual is physically unwell, he is unable to do any work properly. The first objective of Physical Education is to make an individual physically fit so that he is able to contribute in the social development.

### **2 MENTAL AND EMOTIONAL HEALTH**

Besides being physically fit it is very essential for a person to be mentally sound so that he is able to take decisions for the betterment of the society and himself. A person who is mentally sound is able to keep control over his emotions.

**3. DEVELOPMENT OF GOOD HABITS**

A child should be encouraged or inspired to adopt good habits right during his childhood only, because bad habits cause an adverse effect on his development. A teacher should try to encourage a child regarding personal hygiene; like keeping one's ears, teeth, hair and clothes clean. The children must be apprised of the importance of good habits.

**4. EVALUATION OF PHYSICAL DEFORMITIES**

Physical weaknesses hindering a child's physical development should not be ignored rather the same should be cured timely. A proper record of the child's physical development should be maintained so that the child should be prepared to face obstacles likely to occur in the path of physical development.

**5. PREVENTION FROM DISEASES**

Children grow continuously. So they must be protected from any ailment. Diseases adversely affect the overall development of a child. If they are not protected from disease, their mental and physical development ceases to take place. So, we should make efforts to protect the child from any disease.

**6. DEVELOPMENT OF SOCIAL RESPONSIBILITIES TOWARDS HEALTH**

Children must be informed about their social responsibilities along with their physical health. They should be motivated by the uplifting of society right since their childhood. They should be encouraged to contribute in maintenance and cleanliness of the public property.

**7. TO DETERMINE THE LEVEL OF HEALTH**

Health-related objectives should be determined in every school

which must include cleanliness, first aid, clean water management, toilet, management of proper furniture for children and proper establishment of health service centre in the school. According to health educationist, Torner; the following are mandatory points to be kept in mind :

- i) Maintaining clean environment in school
- ii) Maintaining curiosity towards health education among the students.
- iii) Apprising the students of methods of precaution from communicable diseases.
- iv) Co-operating towards the healthy environment in school, home and society.
- v) Organising medical check-up in school to help the students to avoid diseases.

**8. According to CENTRAL BOARD OF SECONDARY EDUCATION (CBSE), the health education is to :**

- i. get rid of diseases after due observation.
- ii. take interest in new techniques of physical development.
- iii. develop the scientific attitude in students in order to promote health-related knowledge.
- iv. impart knowledge among the students about their individual and social health.

**PRINCIPLES OF HEALTH**

Health is associated with various health-related aspects of every individual. The basis of health lies in certain principles. To achieve a good sound health, these principles cannot be ignored. Several new techniques are coming up daily in the field of Health to keep a body

healthy. On the basis of these advancements, principles of health to being modified. Some principles of health are as explained below:

**1. BALANCED DIET :**

For a healthy body, one requires taking nutritious diet daily. If the diet lacks nutrients then health won't develop well. Nowadays, fast-food is affecting the health of children as they prefer such unhealthy food to a healthy and nutritious one. Fast food does not provide required nutrients to the body. Hence, students need to have a balanced diet daily.

**2. PERSONAL HEALTH :**

The students must be imparted knowledge about their personal hygiene in schools. They should be made aware about their health. Minor negligence can be the cause of a major ailment. The students, must be imparted knowledge about their personal hygiene like washing their hands before taking meals, taking bath daily, wearing clean clothes, sitting in proper posture or asana etc.

**3. REGULAR HEALTH CHECK-UPS :**

Medical check-up from time to time is very important for children for their proper growth and development. Vaccination of children should be done to prevent any future ailments. The parents should also be aware about the health of their children.

**4. CO-OPERATION FROM SOCIETY AND FAMILY :**

Formation of a healthy or disease-free society is possible only if all the residents make their contribute for its betterment. They should keep their environment clean so that disease can't even arise we must grow more and more plants to make our environment pollution free, and also awareness regarding their maintenance should be created amongst the people from time to time.

**5. PHYSICAL EXERCISE :**

There is a dire need to make the students understand the importance of physical exercise. As it plays an important role in making one healthy. On one hand, exercise makes one healthy and strong and on the other hand, it helps an individual win game on the ground as well. A healthy body can be achieved only in a playground.

**6. GOOD HABITS :**

Good habits play a significant role in the children's health. In order to make the children healthy, their parents and teachers should inspire them to learn good habits and avoid bad ones. The children should be taught not to spit at public places, to use dustbins, to obey the traffic rules while moving on a road and to help the children and the older people.

**HEALTH-RELATED MEASURES**

Various programmes pertaining to child's health must comprise or include the physical, mental and emotional aspects of the health. The following are some of the significant measures that should be taken care of to keep the child healthy:

**1. HEALTHY ENVIRONMENT :**

Healthy environment should be provided to the children in school, because dirty or unclean environment causes a very adverse effect on their health. Children can make their significant contribution in keeping their school environment neat and clean. The school administrators should plant green and shady trees within the boundary of the school. The children should be encouraged and inspired to maintain the flowers, plants and trees within the school (premises).

**2. PURE AIR, WATER AND LIGHT :**

Arrangement of pure air, water and appropriate light is a must in every school. There is a risk of respiratory problems owing to impure air. Impure water also affects the health negatively. If there is no arrangement of windows or light in a classroom, it can adversely affect the health of the students. Hence, their arrangement is mandatory

**3. MEDICAL EXAMINATION :**

A medical examination of all students is a must at the time of their admission. A proper record of this examination should also be maintained. If any student is affected by any disease, their parents should be informed so that they might get medical treatment or medication done by a good doctor.

**4. ADEQUATE FURNITURE :**

Proper furniture should be arranged in the school because inappropriate desks pose a problem in studying. If the child is not comfortable with their seat, it can harm their physical structure. The spine of the children may get tilted. Hence, there must be proper and appropriate furniture for students.

**5. BALANCED DIET :**

Only that food should be served to the students which are rich in all the required nutrients that promote their health. If a child does not get balanced diet containing all the nutrients, his body weakens. Therefore, a child must get a balanced diet.

**6. YOGA :**

A child should be made to perform “yoga” for a healthy body, soul and mind. Internal impurities can be washed away by yoga. “Pranayama” leads to the good functioning of internal systems. Yoga does not only improves the body but it also plays equal heed to mental and emotional health.

## **SCOPE OF PHYSICAL EDUCATION**

The area of physical education is quite wide. Physical education studies the physical and mental health, health safety, and problems pertaining to health. Its area comprises the following:

### **1. BASIC KNOWLEDGE OF ANATOMY AND PHYSIOLOGY**

Every human being must have complete knowledge of the structure and functioning of his body. If a person knows about the functioning of various organs, muscles and different body systems, he/she can keep his/her body healthy and disease-free. With the help of knowledge of anatomy and physiology, we can lead a healthy life and perform our routine activities properly.

### **2. HEALTH RELATED INSTRUCTION**

In order to maintain the health standard, instructions regarding health play a very important role. Through these instructions health related good habits can be inculcated in a person, for example taking care of personal hygiene, taking care of environment, taking balanced diet etc. Health related instructions inculcate good qualities in a person and help him lead a healthy life.

### **3. HEALTH SERVICES**

When we consult a doctor or a person of equivalent competency his services in case of any ailment to maintain our health, the services are known as health services. The level or standard of health of citizens of any state or country depends on the health services provided to them by the local govt. The more the quality health services provided by the govt, the better will be the treatment availed

### **4. HYGIENIC ENVIRONMENT**

A good environment influences the health of a person a lot. If the

surrounding environment of a person is dirty it will not only affect his physical standard but also his mental, emotional and social standards. If washrooms/toilets in schools or at public places are not clean, it will decrease or lower down the physical standard of a person. In order to improve the environment, cleanliness of surroundings is very important. In order to make the environment clean-green and pollution free green trees should be planted.

### EXERCISE

1. Define Health Education.
2. What is full form of Health Education ?
3. How many types of Health Education are there ?
4. Give detailed description of various types of Health Education.
5. Give detailed account of the principles of Health.
6. Write about any two Health Measures.
7. Give detailed account of the area of Health Education.

—0—

—(10)—



## LESSON - 2

# PHYSICAL EDUCATION AND ITS IMPORTANCE

### MEANING OF PHYSICAL EDUCATION

It is very important to understand the term 'Education' before talking about physical education. Education is a process that starts right from the birth of an individual and continuous until death. Education is a source of bringing a real change in human personality and making an individual progress through in his or her life that leads to transformation. Physical Education is an important part of general education. Physical education means an education about physical activity or motion. The relation between physical education and human beings was established right since the existence of man on this earth. A child's own learning, comprising getting up, sitting, walking, running, playing, doing many other activities and gradually achieving proficiency in these activities, is the physical education only. Physical education not only belongs to sportspersons or students who are studying this subject, but it also belongs to every ordinary human being.

Changes in the conceptions of every subject in the modern age have also resulted in the expansion of the field or area of physical education. Today, physical education is not merely limited to physical exercises, but it is found in every aspect of human life. A person gains physical skills, physical knowledge, values of life and values of living a healthy life through physical education. These qualities inculcate courage in a person and enable him to become capable of tackling the difficulties in life. Several scholars believe that the challenges produced

by today's mechanical age and motionless life can only be dealt with physical education and physical exercises.

### **DEFINITION OF PHYSICAL EDUCATION**

With the progress of life in the modern age, the concept of physical education has also changed. Today each country of the world accepts the importance of physical education. Earlier physical education was considered to be a means of sports and recreation only, but today it has been included in the field of education as an important subject. Due to various changes that took place from time to time, the definitions of this subject also underwent changes. Some important definitions of physical education given by different scholars are as under:

#### **ACCORDING TO CHARLES A BUCHER :**

1. "Physical Education, an integral part of the total education process, is a field of Endeavour that has as its aim, the development of physically, mentally, emotionally and socially fit citizens through the medium of physical activities that have been selected with a view to realize these outcomes."
2. **According to J.B. Nash :**  
"Physical Education is that phase of the whole field of education that deals with big muscle activities and their related responses."
3. **According to R.Cassid :**  
"Physical Education is the sum of changes in the individual caused by experiences centering motor Activities."
4. **According to Delbert Obertibfer :**  
"Physical Education is the sum of those experiences which come to the individual through movements."

From the above definitions, it is clear that physical education brings positive changes in the behaviour of a person. Physical education contributes significantly to the growth and development of children.

### **AIM AND OBJECTIVES OF PHYSICAL EDUCATION**

Generally, ‘Aims’ and ‘objectives’ are understood to be the same, but there is much difference between these two words. In general, the word ‘Aim’ refers to a destination to reach, whereas ‘objectives’ are the steps or different ways to reach the aim. Hence, ‘aim’ is usually single whereas objectives can be more than one.

### **AIM OF PHYSICAL EDUCATION**

The ‘aim’ of physical education is to develop all-round development in a person so that he might be able to face difficulties of his life and become a better citizen of the country or society. According to the Central Advisory Board of Physical Education and Recreation, “The objective of Physical Education is to make every child physically, mentally and emotionally fit, and to inculcate in him the personal and social qualities so that he is able to improve the quality of his lifestyle.”

### **OBJECTIVES OF PHYSICAL EDUCATION**

In order to accomplish the aim of all-round development of man, one has to pass through various stages. In simpler words different means are adopted to reach the destination. These stages are called Objectives. Various scholars have given their views regarding the objectives of Physical Education. After a study of all the objectives represented by the scholars, these can be categorized under the following five headings :

#### **1. PHYSICAL DEVELOPMENT :**

Physical Development is the main objective of physical education. The main purpose of this objective is to make a person

physically strong and fit so that he might be able to do his routine works of life easily. This increases man's strength, movement, patience and flexibility and he becomes able to do his works quickly and without exhaustion.

**2 MENTAL DEVELOPMENT :**

As general education enhances the mental level of a person, physical education also helps in the mental development of a sportsperson and his associates. In order to make progress in the field of sports, only physical fitness alone is not sufficient, but it is also very important for the sportsperson to be mentally sound. Through physical education, the sports person receives knowledge and information about balanced food, sports rules, physical structure etc.

**3. EMOTIONAL DEVELOPMENT :**

In a game, a situation often arises in front of sportspersons, which become a challenge for him or her. These situations are associated with the sportsperson's feelings, and the sportsperson has to overcome these situations, with the help of his own understanding and strength of training he had gone through. Sometimes, a sportsperson loses the game even after a long hard work. Such defeat is tough for him to bear, but he gets out of this situation by controlling his emotions and starts preparing for the next competition. Like an ordinary human being, a sportsperson continuously feels and passes through the momentum of love, anger, fear, ect, but through physical education, the sportsperson learns to overcome such emotions.

**4. SOCIAL DEVELOPMENT :**

The team's success in a game depends on the mutual support of all the teammates. Through the participation of sports or games, a player attains qualities like obedience to the rules of the game,

discipline, cooperation, non-violence etc. He obeys his coach and team captain. Thus, physical education fulfils the objective of social development.

#### **5. DEVELOPMENT OF NEURO-MUSCULAR CO-ORDINATION :**

Development of neuro-muscular co-ordination means the coordination between the functions of brain and muscles. This ability is developed through physical education and the sportsperson completes his work with little expenditure of energy and without exhaustion. Physical activities improve the sportsperson's reaction time which enables him to do his work quickly.

#### **SCOPE OF PHYSICAL EDUCATION**

As we have already read that changes in time have led to a lot of changes in physical education like in other subjects. Physical education in ancient times was limited to just playing, drill activities and marching. Physical education has become an important part of the life of a person today.

Today the area of physical education has become so vast that it not only includes games and sports but also entertainment and physiotherapy. It also is contributing to the physical, mental, social, emotional and moral development of students. The field of physical education is the combination of the following

##### **1. CORRECTIVE EXERCISE :**

Through these exercises, the physical problems of a sportsperson or a layman can overcome. Sometimes a physical disorder occurs due to the weakness of muscles, bone formation or an injury. Such flows can be treated with the help of Physiotherapy through light exercises.

**2. SELF DEFENSE EXERCISES :**

It includes all those activities that can help a person for self-protection. Through these activities, individuals are taught different kinds of self-defense skills. Games like Gatka, Boxing, Judo, Karate, Wrestling, etc. come under this training.

**3. RHYTHMIC :**

The activities which are performed with music and rhythm are included in this like dumbbell, lazium, rhythmic gymnastics, and folk dance etc.

**4. RECREATIONAL ACTIVITIES :**

Recreation has the power to fill freshness in the life of a person after he gets fed up with the day-to-day running of life. When he is exhausted after a daily hard work of his routine life, he can perform various types of activities for entertainment; such as camping, picnic, mountaineering, fishing etc. All these activities of entertainment are included in the field of physical education.

**5. YOGIC ACTIVITIES :**

Yoga is an ancient subject of India which is now becoming popular in the whole world. Yoga involves various “asanas”, “pranayama” and many other activities which are used for the purposes of exercise and meditation.

**6. EDUCATIONAL SPHERE :**

In physical education get information about different types of academic subjects such as biology, physical structure, psychology, physiotherapy etc. Students can adopt these subjects as their profession in future.

**7. VOCATIONAL SPHERE :**

Physical education not only prepares a sportsperson but also provides him or her with the opportunity to join major

professions as a physical education teacher, coach, sports journalist, commentator etc.

### **IMPORTANCE OF PHYSICAL EDUCATION**

Today, physical education has become an important part of general education. Sports create a sense of cooperation and collaboration among the sportspersons and also help in the overall development of a person. The importance of physical education is as below:

#### **1. DEVELOPMENT OF MORAL VALUES :**

The sphere or curriculum of physical education is very vast. Physical education not only develops physical and mental aspects of a person, but it inculcates qualities like tolerance, brotherhood, respect for others, moral values etc. in him.

#### **2. DEVELOPMENT OF LEADERSHIP :**

Physical education develops a sense of leadership among the sportspersons. They are provided with opportunities to become a captain and lead their team.

#### **3. KNOWLEDGE OF HEALTH EDUCATION :**

There is a deep relationship between physical education and health education. It is impossible to get perfection in sports without the knowledge of health education. Students are imparted knowledge of balanced diet and maintenance of health in physical education. A common man can also keep his health fit with the help of sports and exercises.

#### **4. PROVIDING EQUAL OPPORTUNITIES TO SPORTSPERSONS**

There is no place for any kind of inequality in physical education. Irrespective of their economic or financial status,

physical education provides the players with equal opportunities, if they have sports-related talent.

**5. NATIONAL INTEGRATION**

India is a multi-lingual country where indifferent languages are spoken in different regions. There are inequalities and quarrels over the issues of provinces and languages. Physical education is such a field which provides a sportsperson with the opportunities to play without facing any partiality, irrespective of the province or language he or she belongs to. Thus physical education also promotes national integration

**6. COMMUNICAL HARMONY AND PHYSICAL EDUCATION :**

Physical education does not acknowledge any kind of discrimination based on cast, colour and creed. Physical education promotes and encourages sportsperson of all categories to play for the country and to come together at a common platform. Thus it prepares a platform for the communicational harmony.

**7. PROPER USE OF LEISURE TIME :**

The proverb is very common, “An idle mind is the devil’s workshop”. Physical education provides ways to use idle time properly. A person can use his spare time to keep his health good and avoid bad habits.

**8. DISCIPLINE, TOLERANCE AND PATRIOTISM :**

Physical education creates a sense of discipline, tolerance and patriotism among sportspersons. Through sports, sportspersons learn to follow discipline and they develop qualities of tolerance and patriotism. There are several such programmes in physical education such as Scout and Guiding, NCC, Camping etc. through which children are motivated to work together.



**EXERCISE**

1. How to handle the challenges generated by the life ?
2. Write the definition of Health Education.
3. What is the aim of Health Education ?
4. Explain any three objectives of Health Education in detail.
5. What are the importance of Health Education ? Explain in detail.

—0—

—(19)—

### LESSON - 3

## INTRODUCTION TO ANATOMY AND PHYSIOLOGY

Human body is a complex machine. As any machine works in combination with its different parts, similarly different parts of human body work collectively and run the physiology of human body. Anatomy and Physiology is a subject related to human biology which provides us information or knowledge regarding the anatomical structure and functioning of the human body.

### ANATOMY

Anatomy and Physiology is the study of the physical structure and its total system management. Through its study, we get knowledge regarding structure, size, and shape and positioning of the human organs. The word Anatomy is a composed of two Greek words “Ana + Tomy”. The word “Ana” means from above and “Tomy” means tearing or dissecting. This means dissecting the internal organs of human body and studying their structure, for example, cells, tissues, bones, heart, brain, lungs, Intestine liver etc.

By carrying out the study of anatomy, one comes to know that human organs are formed with the origin of human cells. Tissues are formed with the Group of cells. The Group of tissues forms organs and the combination of organs forms system.

## COMPOSITION OF ANATOMY

1. Cell
2. Tissue
3. Organs
4. System

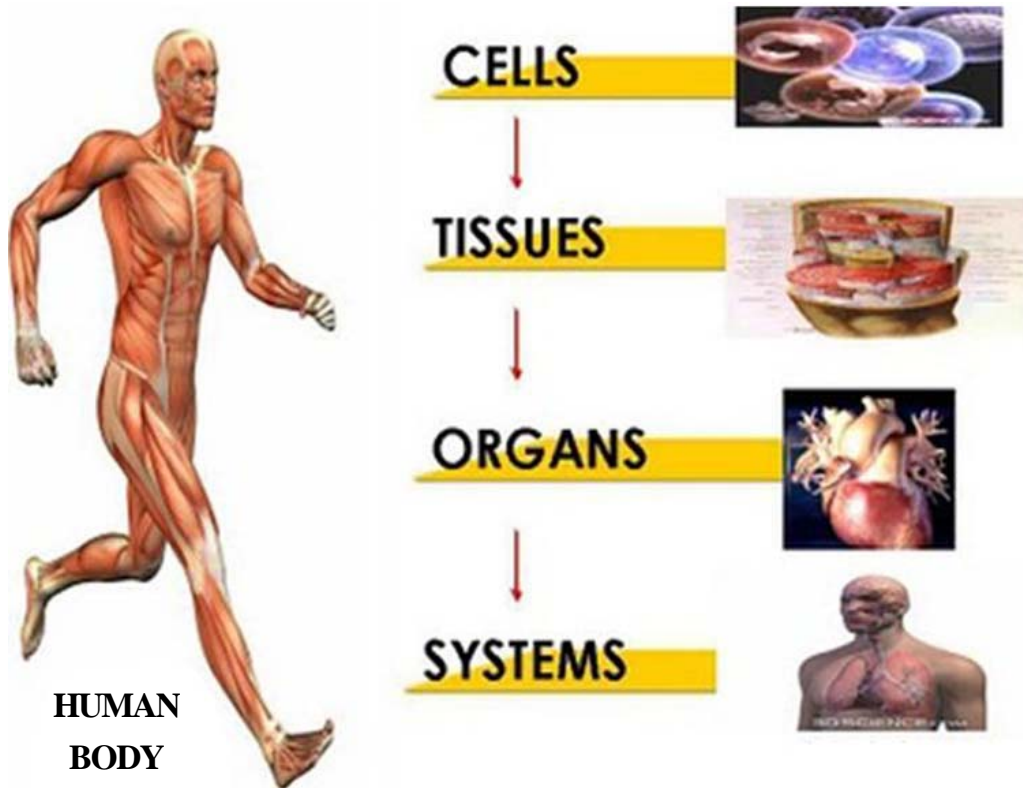

*Cell to tissue, tissue to organs, organs to system*

### 1. CELL :

The cells are the basic or fundamental unit of life, which cannot be viewed with the naked eye. These can be seen only with the help of a microscope. Cells store food inside them and produce energy by oxidation of food. This energy is used to perform physical activities. These help in the secretion of the hormones.

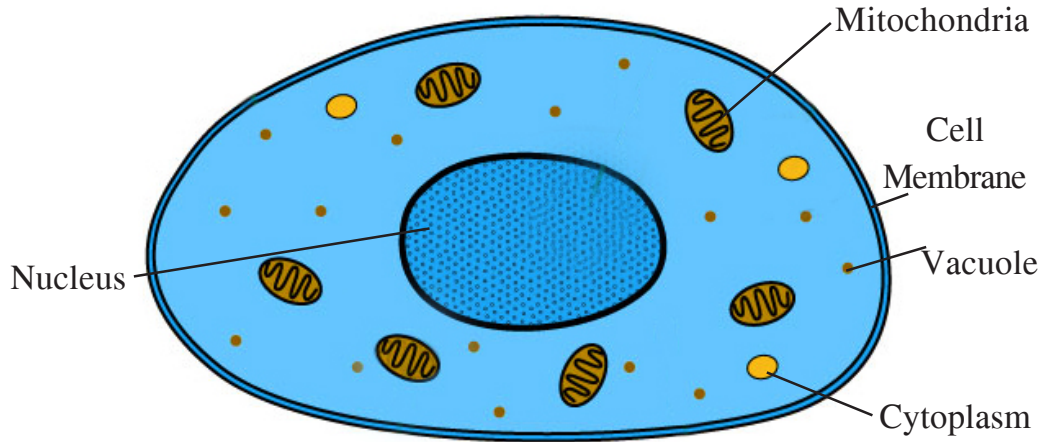

*Cell*

## 2. **TISSUE :**

Groups of cells form Tissues. When cells of the same shape and functioning work together in groups, they are called Tissues. These tissues contain 60% to 90% water. There are four types of tissues found in the human body namely Connective Tissue, Epithelial Tissue, Muscular Tissue and Nervous Tissue.



**Connective tissue**



**Epithelial tissue**



**Muscle tissue**

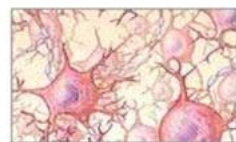

**Nervous tissue**

*Types of Tissues*

## 3. **ORGANS :**

Organs are formed with the combination of tissues. These organs

are groups of cells of the same formation and functioning, like Heart, Brain, Intestines, Stomach, Lungs, Tongue etc.

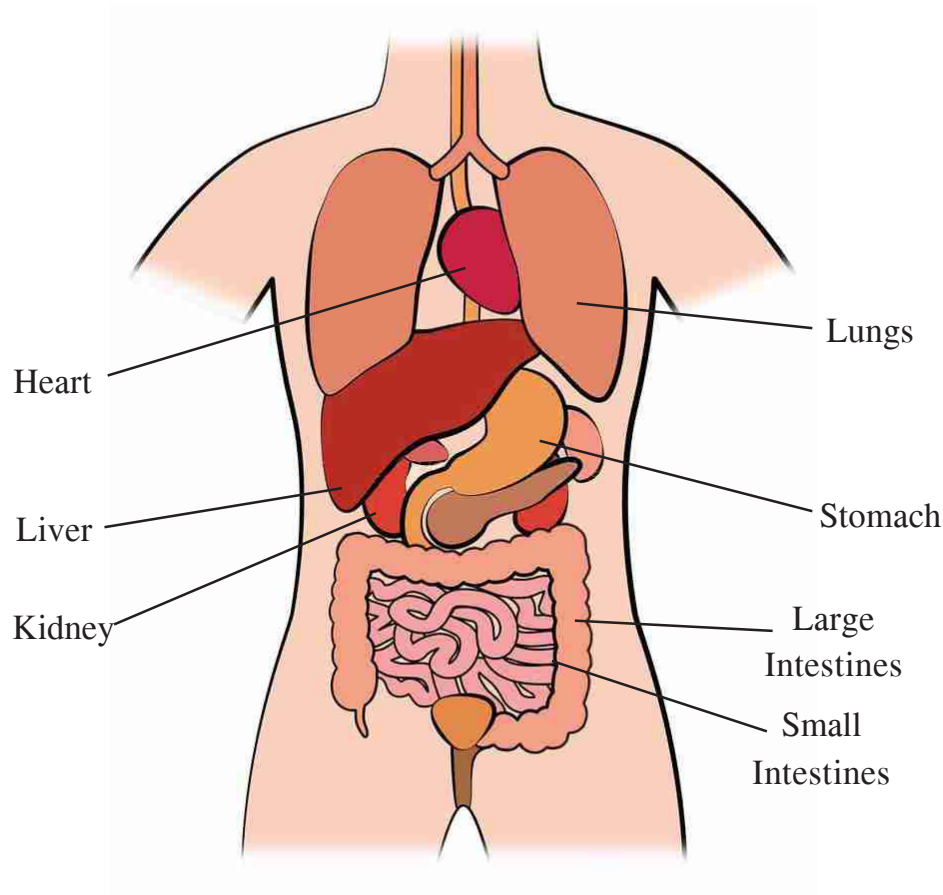

*Body Parts*

#### 4. SYSTEMS :

Groups of cells form tissues, groups of tissues form organs and groups of organs of similar functioning form a system. In simple words, systems are formed with the combination of different organs of the human body, like Respiratory System, Blood Circulation, Muscular System, Nervous System, Reproduction System, Excretory System etc. Different systems perform their own function in combination with other systems.

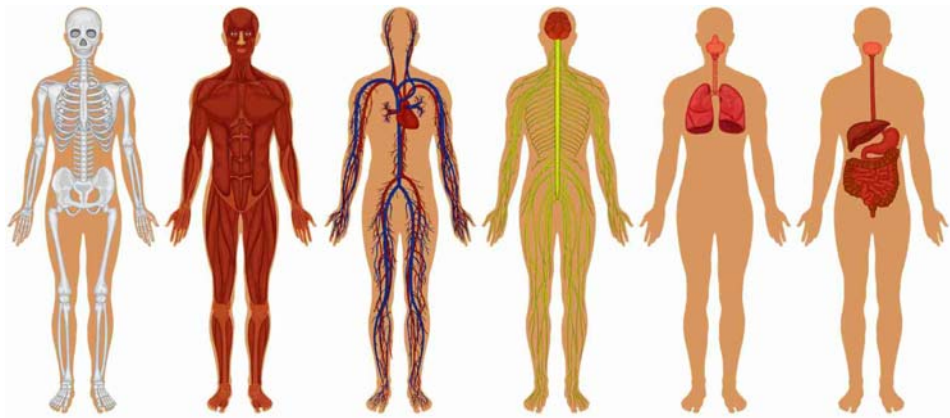

### *Systems of the Body*

## **BONES**

Human body is a framework of bones. Bones play an important role in our body. These impart shape to the human body. These protect the tender organs of the body, such as Heart, Lungs, Brain etc. The human body is formed by the combination of different bones, such as long bones, small bones, flat bones, irregular bones and Sesamoid bones. These bones are made up of organic and non-organic substances. There are a total 206 bones in the human body.

<b>NAME OF THE BONES</b>	<b>NUMBER OF BONES</b>
Facial and cranium bones	22
Vertebral, Ear Ossicles and Hyoid bone	33
Rib Cage	24
Sternum	1
Collar Bones	2
Scapula	2
Arm Bones	60
Leg Bones	62
<b>Total Bones</b>	<b>206</b>

## CLASSIFICATION OF BONES

On the basis of their organization and size, the bones are divided into five different types.

1. Long Bone
2. Small Bone
3. Flat Bone
4. Irregular Bone
5. Sesamoid Bone

### 1. LONG BONES :

These bones are found in arms and legs. These help us to move around and perform various activities. It is impossible to perform physical activities without these bones. These bones have two ends and one tubular shaft.

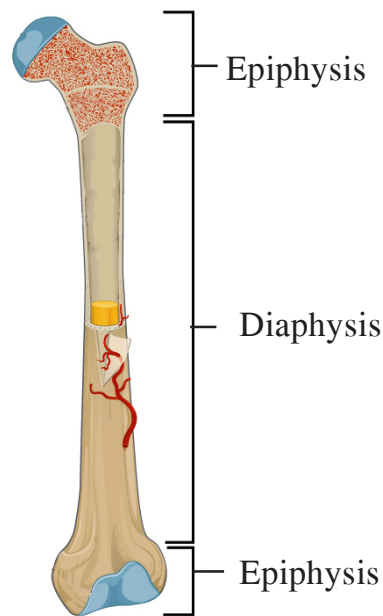

*Long Bones*

## 2. **SMALL BONES :**

Small bones are small in size, cubed shaped and are of spongy in nature. These bones are covered with a large of connective tissues. These bones are stronger than the long bones, which enables them to bear maximum weight. These bones are found in the ankle and wrists.

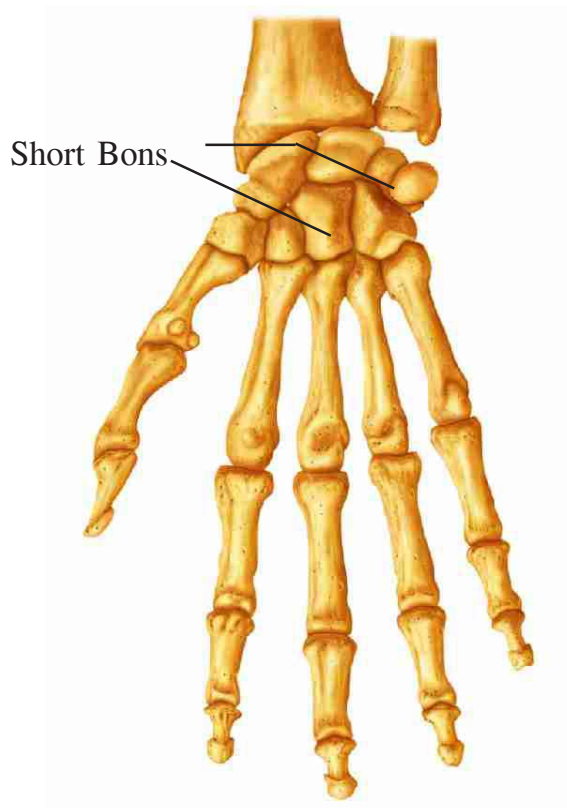

*Small Bones*

## 3. **FLAT BONES :**

These bones are thin and flat. These bones are made up of the combination of two layers of spongy bones and compact bones. The ends of these bones are covered with the layer of Cartilage. These bones are found in ribs, sternum, Ear Ossicles and scapula etc.



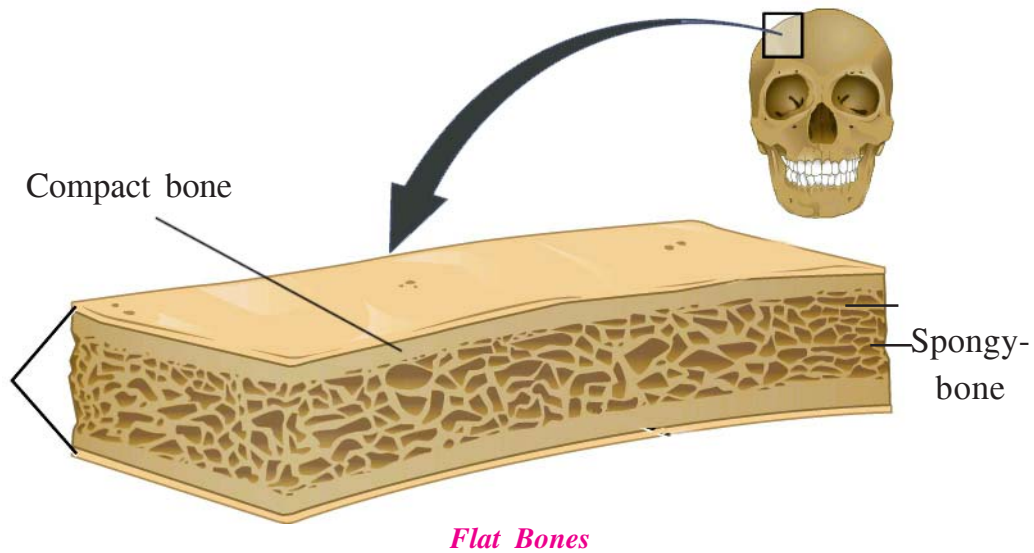

**4. IRREGULAR BONES :**

The irregular bones have no fixed size. The structure of these bones is complex. These bones protect the tender organs, such as the nervous tissue and spinal cord. These bones are found in the bones of the skull, hips, and spine.



**Vertebrae**



**Pelvis**

*Irregular Bones*

**5. Sesamoid Bones :**

These are small, free-moving and sesame seed-like bones, which

are small, thin and flexible. These bones develop in the muscle tissues close to the bone joints. These help in the formation of Sesamoid bones.

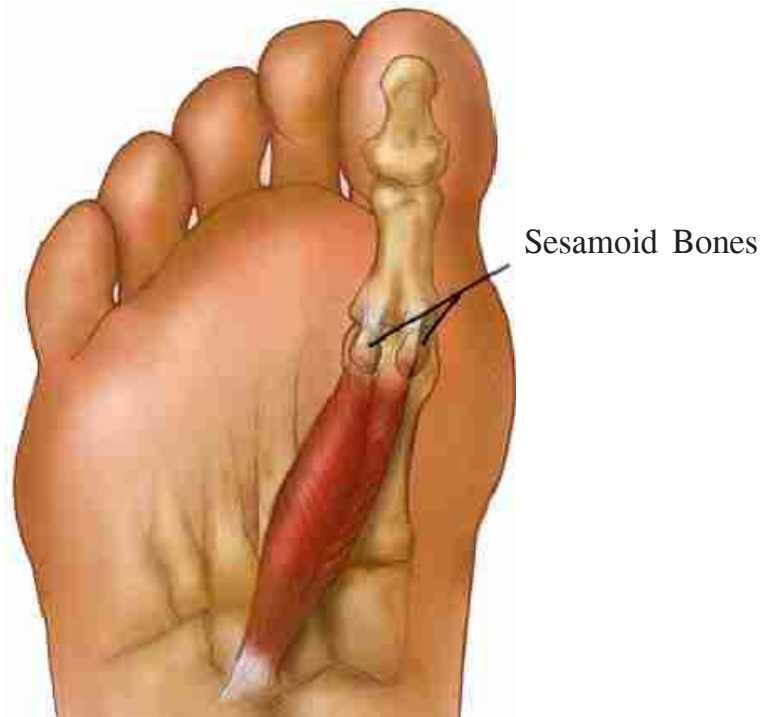

*Sesamoid Bones*

## **JOINTS**

Joints refer to the position where two or more ends of bones are joined. Human body moves and performs activities because of these joints only. Joints are capable of bearing maximum pressure and weight due to human activities. On the basis of their structure and functioning, joints are divided into three parts.

1. Immoveable Joint
2. Moveable Joint
3. Slightly Moveable Joint

### 1. IMMOVEABLE JOINTS :

The Joints which do not have any movement are called Immoveable Joints. The ends of bones of these joints are firmly embedded with each other. That is why there is no space or movement in these joints. Therefore, they are called Immoveable Joints. These types of joints are found in the face and skull.

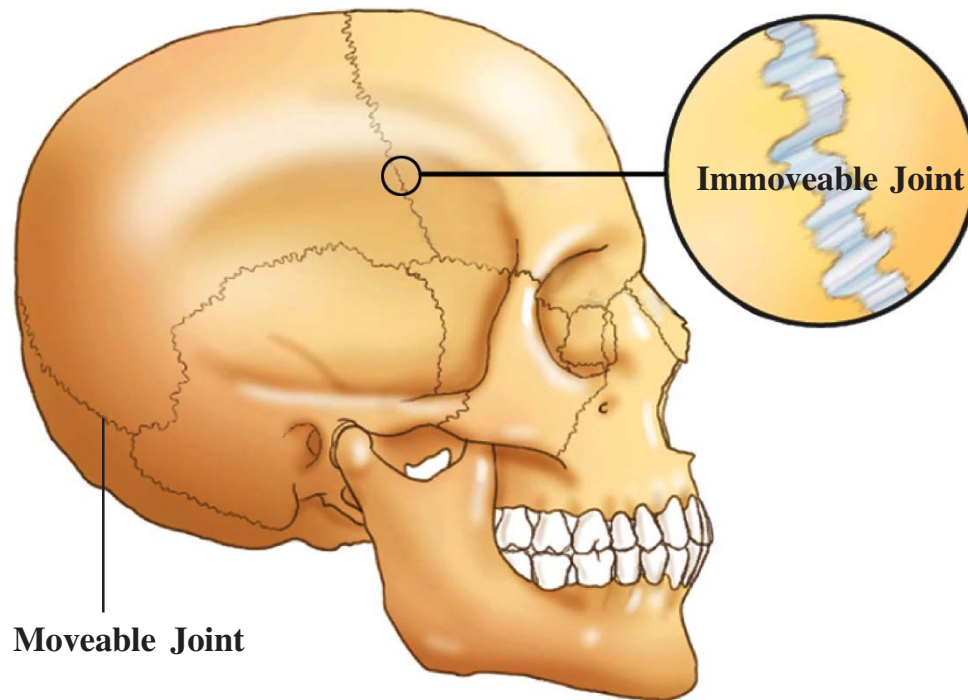

### *Immoveable Joints*

### 2. MOVEABLE JOINTS :

These joints cause movements in the body. The number of such types of joints is very high in the human body. Both ends of bones of such joints have covered the layer of Cartilage, due to which ends of the bones do not scratch against each other. These joints are further of 6 types:.

SR.NO.	NAME OF THE MOVEABLE JOINT	LOCATION
1	Ball and Socket Joint	Head of Humerus and Glenoid Cavity, Femur.
2	Gliding Joint	Ankle and Wrist
3	Hinge Joint	Knee Joint, Elbow Joint
4	Condyloid Joint	Meta-Carpals and Phalanges
5	Pivot Joint	Atlas and Axis of Skull, Radius, and Ulna
6	Saddle Joint	The joint of hand and foot.

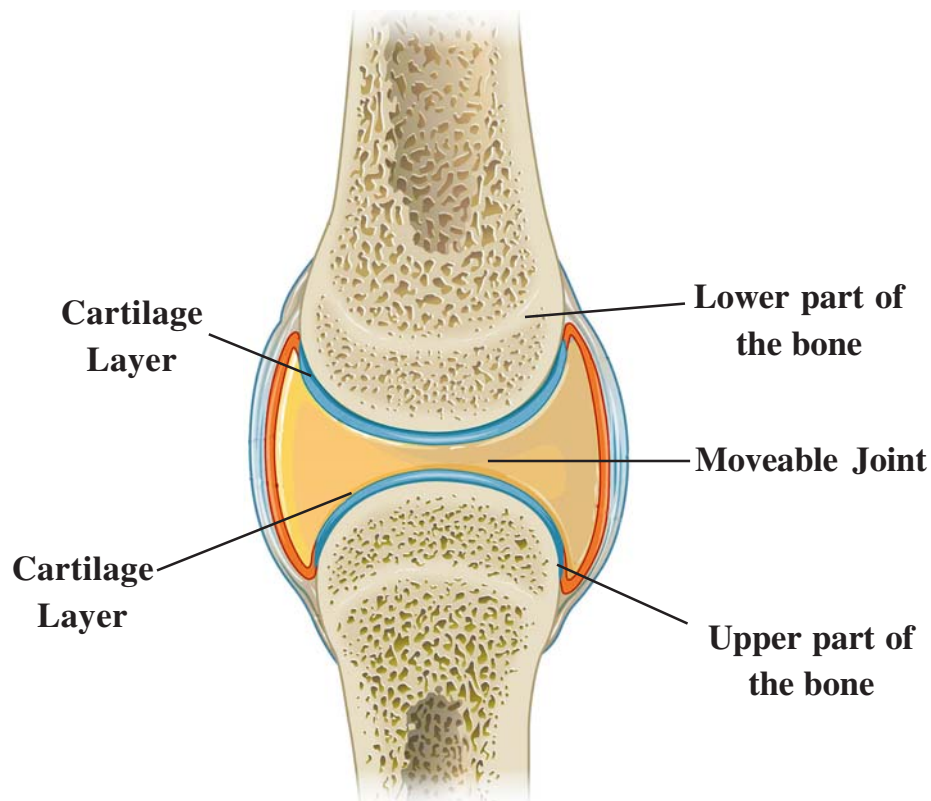

*Moveable Joint*

### 3. SLIGHTLY MOVEABLE JOINTS :

These are the joints, in which the ends of the bones are stuck with each other, but even then there is a space between these joints, which makes restricted movement possible in the bones, or in words, the movement is little or less. These are called slightly Moveable joints. The ends of these joints are covered with layers of cartilage, which protects them from various scratches.

It has a layer of the cartilage on, which protects the bones from scratches.

**Joint between each Vertebrae**

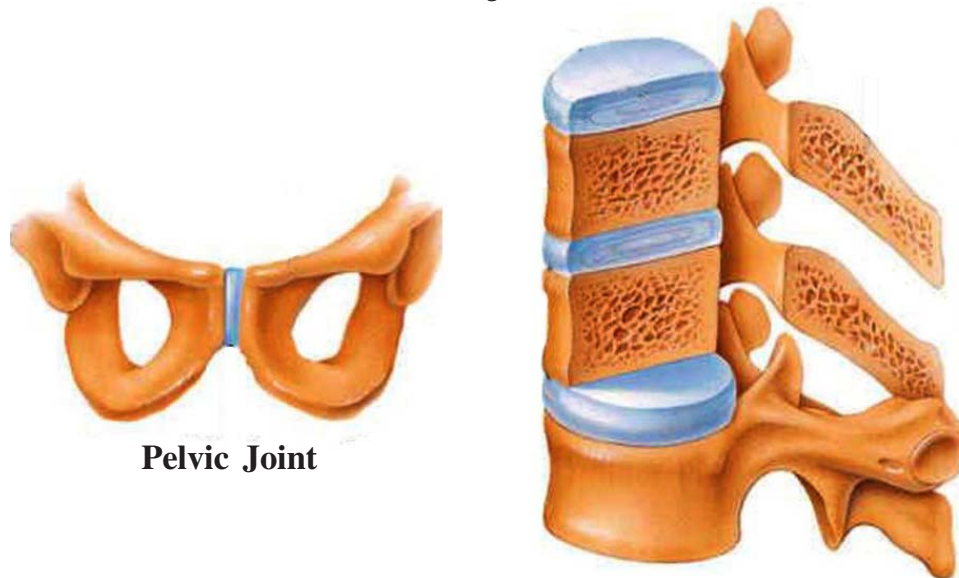

**Pelvic Joint**

*Slightly Moveable Joints*

### PHYSIOLOGY

Physiology is a branch of Human Biology that studies the different functions of the internal organs of the human body. It is a subject that imparts knowledge about variations caused by the functioning of internal organs of the human body. A man performs various types of physical activities in day-to-day life. Due to these activities, many changes or variations occur in the physical organs and

systems, like the enhanced size and functioning ability or capacity of Heart, Lungs, Intestines, Liver, Muscles etc. The study of these changes or variations is called Physiology. It is the science which deals with the study of various functions of the human body for example the functioning of Respiratory System, Blood Circulatory System, Nervous System, Digestive System, Skeletal System, Excretory System, Muscular System and Reproduction System

### **Contribution of Anatomy and Physiology in Physical Education and Sports Sector :-**

In today's mechanical age, physical education and sports play an important role in human life, which leads to the overall development of a person. Various types of activities are performed daily in the playground by the sportspersons. Repeated practice of these sports activities improves the performance of the players as well as enhances the competence of their body parts and systems. Therefore, it is necessary to understand the structure and functioning of different organs of the players in order to enhance their sports performance. The knowledge of anatomy and physiology is mandatory to keep oneself fit and strong and to heal injuries during games.

#### **1. THE BASIC REQUIREMENT OF TEACHERS AND COACHES :**

Various types of activities are performed and movements made by the players on the ground during practice. These activities are done owing to the joints and excitement in the muscles. Therefore, players and teachers must have knowledge of the anatomy and physiology. They must gain knowledge about different physical movements performed by the body and also about the joints around which these movements are made.

#### **2. TO IMPROVE THE PERFORMANCE OF THE PLAYERS :**

Regular researches are being made in physical education and

games to ensure maximum improvement in the performance of the players. Daily exercise by the players, leads to enhanced strength and enhanced functioning of the ability of the various system to work, such as an increase in the size and functioning of muscles, heart, lungs, etc. Owing to this, all the performance of the player can be improved.

**3. TO INCREASE PHYSICAL FITNESS :**

In the world of sports, players must be strong and competent which means that there must be coordination in different body parts and traits like speed, strength, tolerance, and flexibility. Apart from his physical fitness, the sports competence of a player depends on the structure and functioning of the body. Understanding of various physical and chemical variations take place in the body during exercise with which the physical competence of the players can be improved.

**4. ASSISTANCE IN CHOOSING THE GAME :**

Anatomy is the science that helps an individual to choose his game as per the body structure. Keeping in mind, the size, weight or capacity of the player's body, they can be selected for a particular game. For instance, players having long arms and legs are selected for the games like handball, basketball etc. and overweight players can be selected for sports such as Weightlifting, boxing etc.

**5. KNOWLEDGE OF THE TYPES OF INJURIES :**

During a game, the players may get various types of injuries. Therefore, it is important for players and teachers to have knowledge about the types, cause and treatment of injuries, such as sprains, strains, pressure, running knee, tennis elbow, hamstring injury, ankle injury etc. The exact location of injury can be detected theory the knowledge of anatomy and symptoms

of the injuries can be seen through the functioning of the body called Physiology.

**6. REDUCING FATIGUE :**

Physical competence of the players increases with physical activities. But due to physical and chemical transformations, the body of a player is exhausted, fatigued, which increases the amount of lactic acid and decreases the amount of glucose in the body. In such a situation, appropriate rest and use of instant energy sources can compensate the loss of Glucose by which fatigue can be either de-rooted or at least reduced.

**7. REDUCING INJURIES DURING THE GAMES :**

During a game, the players have to fall a prey to a lot of injuries. Different types of safety guards or equipment have been invented to reduce sports injuries such as leg- guard, shin- guard, chest-guard, head and ankle guards etc. The injuries can be avoided with the use of safety equipment.

**8. FOR THE REHABILITATION :**

During a game, the knowledge of Anatomy and Physiology play an important role in the instant recognition and treatment of the injuries. The player can be pre-prepared for the game by adjusting the position of the spine, ligaments, tendon, and muscles etc.,

**9. TO IDENTIFY INDIVIDUAL DIFFERENCES :**

Knowledge of anatomy and physiology makes individual to understand various individual differences as per gender such as height, weight, size of body parts. Based on these differences, sports equipment, safety equipment, playground and timings of game etc. are decided.



## 10. FOR GOOD HEALTH

The knowledge of anatomy and physiology can help players to keep their body fit and healthy. Players can improve their health, body parts and activities. Thus they can make their body disease free and enable it to use minimum energy and give maximum work output.

### EXERCISE

1. **Fill in the Blanks :**
  - A) A human body is a .....machine.
  - B) Different organs of human body collectively run the .....of the body
2. What is Cell ?
3. What are bones ? Write in detail about their types.
4. What are joints ? Name their types and explain any one type in detail.

—0—

—(35)—

## LESSON - 4

# YOGA

Yoga is an age-old practice of India. In today's mechanical world, every person is physically and mentally burdened. Yoga is the only way by which one can get rid of this burden. Although Yoga originated in India yet today it is widely accepted all over the world. Yoga leads to the spiritual development of beings. In the present scenario, the main focus of Yoga is on physical fitness, mental development and emotional stability of students. In a nut-shell, Yoga makes us physically and mentally fit.

### **HISTORY :**

Thousands of years ago, saints and sages originated Yoga to get rid of ailments and to attain eternal happiness. As per Yogis, yoga began from the period of Lord Shiva but if we follow chronological history, yoga was initiated by Maharishi Patanjali. Gradually, knowledge about yoga kept enhancing. Several saints, sages and priests contributed to this. Currently, yoga is being practised in every nook and corner of the world. Keeping in view the importance of Yoga, United Nations General Assembly (UNGA) passed a resolution on Dec 11, 2014, with the consent of its 193 members, and proposed to celebrate Yoga day on June 21st as International Yoga Day. Thus, 21st June is now celebrated as International Yoga Day. Today every person is practising yoga and is well aware of health.

### **MEANING :**

Etymologically, the word Yoga is derived from the word 'Yuj'

which means “to add or unite” which further means to hybridize body, brain and spirit. A sound mind lives in a sound body. It is through yoga that we can keep our mind and body aloof from worries, diseases and have a sound, healthy body.

### **IMPORTANCE :**

Good health is the dream and right of every person. But this dream and right depend on the thinking, society and surroundings of the concerned person. If our immune system and thinking power are up to the mark, then only can one keep one's body healthy and free from diseases. With the help of yoga, one can own a jubilant, active and energetic body. Good habits can be inculcated right since beginning in the students with the help of yoga. Yoga helps the students to release their mental stress and enhance their stamina, endurance and physical level. We can concentrate on our mind with yoga. If the mind is concentrated then we can easily do any work and the result of the work too will be good. Mental and physical harmony enhances with Yoga.

### **GUIDELINES FOR YOGA :**

1. Before doing asanas Surya Namaskar should be performed.
2. The best time for yogas in the morning hours.
3. Yoga should be practised regularly.
4. Initially, yoga should be performed under the supervision of an expert.
5. Initially, relaxing and later cultural positions should be practised.
6. Yoga should be practised slowly without any jerks. There should be no jerks in yogapositions.
7. Yoga position should depend on the physical capacity.
8. Yoga can be practised in the evening too but it should be done at the gap of 2-3 hours from the major meal.

9. Yoga should be practised in an open, hygienic and peaceful environment.
10. “Asanas” should not be performed on the concrete floor, rather on some carpet or mat.
11. It is better to take bath beforehand with either hot or cold water depending on the weather.
12. During Yoga, the activity of inhaling and exhaling should be in a proper sequence to gain better health.

### **SURYA NAMASKAR**

‘Surya’ means ‘sun’ and ‘Namaskar’ means ‘to salute’.It means salutation to the sun. Twelve activities are involved in the Surya Namaskar which keep the various body parts active and enhance flexibility. Surya Namaskar leads to the strengthening and development of mind power. It also increases the age of a person.Surya Namaskar makes one enjoy active and harmonized body, breath and mind.

**Various activities of Surya Namaskar become clear from the following picture. Surya Namaskar act is as under :**

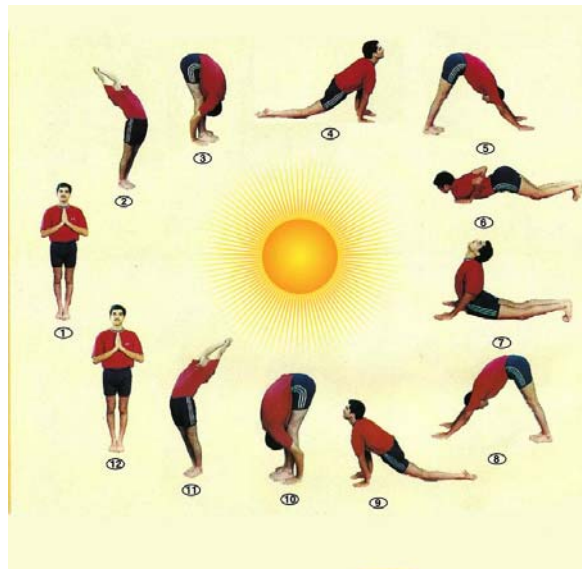

**METHOD :**

- 1) Stand straight with hands and feet forwarded in the Namaskara position.
- 2) While inhaling, lift both arms above the head and bend backwards by bending waist.
- 3) Touch the ground while exhaling and touch forehead with knees. Knees should be straight during this position.
- 4) Straighten the right leg at the back. Left foot will be enveloped in both hands. Stay positioned like this for a few seconds.
- 5) While exhaling, take the left leg backwards like the right one and join the feet. Lift the waist by making a triangular body position. Heels must be stabilized on the ground.
- 6) While inhaling, place knees, chest and chin on the ground and lift the lower back upwards.
- 7) While inhaling, make an arch of the spine and lift body backwards right from lower waist to upper body. Concentrating weight on arms, lift the head upwards. The bottom part of legs and abdomen will be positioned on the ground. This position is somewhat similar to Bhujang Asana.
- 8) While exhaling, bend towards the ground from waist. Place head between both arms and lift waist upwards.
- 9) While inhaling, bend right knee and hold it in both hands and left leg will be straightened backwards. The way we took our feet backwards in the 4<sup>th</sup> act, similarly we are to bring them back to the original position.
- 10) While exhaling, let the straightened left leg be at the back positioned parallel to the right one. Both knees must be straight and in the initial position, the head should be touched to the knee. Both hands should be parallel to the feet on the ground.

- 11) While inhaling and take both arms up and while touching them with ears, bend backwards.
- 12) While exhaling and getting back to the original position, stand straight with hands folded in the position of Namaskara.

One must be positioned for a few seconds while performing each of them. These should be performed depending on the body capacity.

### **BENEFITS :**

- 1) Surya Namaskar enhances strength, power and flexibility.
- 2) It improves concentration.
- 3) It reduces excess fat.
- 4) It energizes the body.
- 5) It is helpful in increasing height of children.
- 6) It gives warmth to the body.
- 7) It is helpful in blood circulation.

### **ASHTANGA YOGA**

- 1) Yama
- 2) Niyama
- 3) Asana
- 4) Pranayama
- 5) Pratihara
- 6) Dharna
- 7) Dhyan
- 8) Samadhi

## YAMA

Yama refers to the inculcation of moral values in the individual like truth, honesty, punctuality.

## NIYAMA

Niyama refers to the union of body and mind. It is the primary aspect of Yoga to follow moral values and ethics like respecting elders, loving youngsters etc. With the help of Yama and Niyama, we can concentrate on our work.

## ASANA :

A particular position of sitting for some time while keeping in mind the harmony of body and respiratory system is called ASANA. While doing ASANA the hands are also kept in a special position.

**Broadly speaking, Asanas are of three types :**

**i) Meditative Asana :**

Padam Asana, Sidh Asana, Sukh Asana, Vajar Asana.

**ii) Relaxative Asana :**

Shav Asana, Makar Asana and Bal Asana.

**iii) Cultural Asana :**

Pawanmukt Asana, Hastpad Asana, Kati Chakkar Asana, Parwat Asana, Chakar Aasna, Shalbhasana, Variksh Asana, Ushtra Asana

**i) Meditative Asana**

Meditation is the crucial practise in yoga. Almost all yoga asanas are performed in the position of meditation. Out of all meditative asanas, we will discuss Padam Asana and Vajar Asana.

**a) PADAMASANA :**

Padma Asana is a hybridization of Padam and Asana. Padam means Lotus. In this Asana, one is seated with legs in the position of a lotus. This is a meditative Asana.

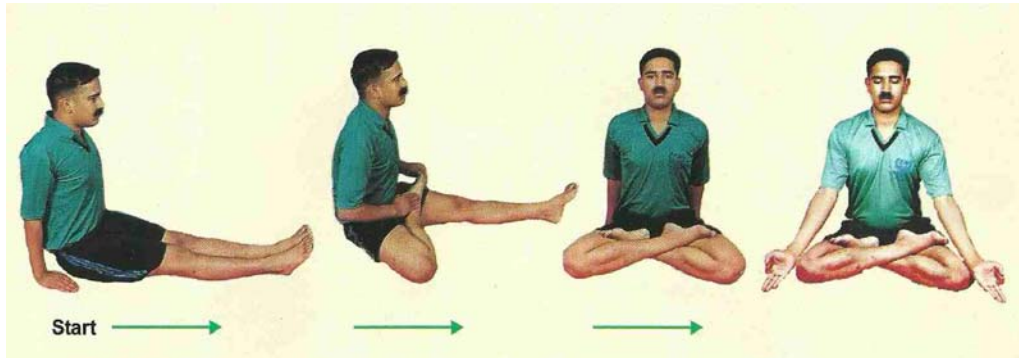

**METHOD :**

- 1) Sit on the floor.
- 2) Fold your right leg slowly and place right foot on left thigh.
- 3) Then fold left leg and place left foot on the right thigh.
- 4) Then sit in the posture. For this posture, join index finger with the thumb. Keep other fingers straight.
- 5) Then place hands on knees with spine straight.
- 6) While coming back to the original position, take the left leg off the right thigh and then the right leg.

**BENEFITS :**

- 1) It sharpens memory and concentration.
- 2) It imparts peace of mind.
- 3) It improves Digestion.
- 4) It improves Flexibility in legs.



### PRECAUTIONS :

Those persons who have any kind of injury or pain in knee, should not perform this asana

#### b) VAJRA ASANA

This is a meditative Asana and is the only Asana in yoga that can be done after meals too.

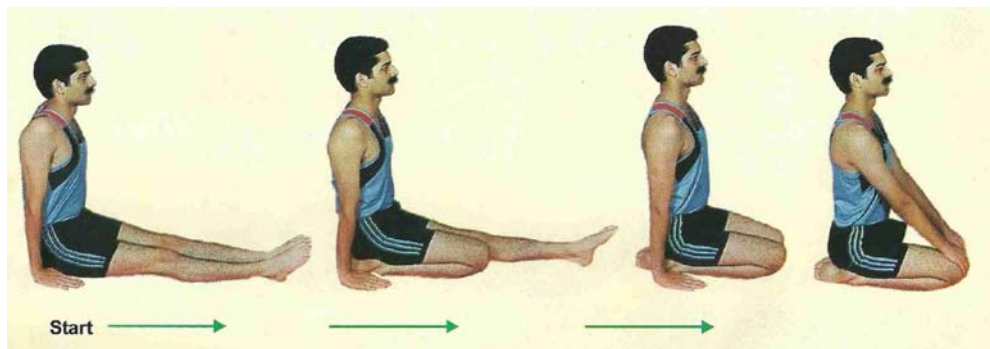

### METHOD :

- 1) Sit with your both legs stretched on the ground.
- 2) Fold left leg and take foot backwards and then sit on the foot. Similarly, take the right leg back and then sit on the feet.
- 3) There should be a little different in both heels and toes should be on each other.
- 4) Both hands should be on knees.
- 5) The spine should be straight and eyes closed in this Asana. Initially, this Asana should be done for 10-15 seconds.
- 6) To come back to the original body position, bend a bit towards the right and then straighten the left leg and later bend to the left and straighten the right one.

**c) ARAMDAYAK ASANA :**

These asanas are performed to relax all the parts of the body, brain and mind by bringing the body to its comfortable position.

**a) SHAV ASANA :**

‘Shav’ is a Sanskrit word which means ‘Dead Body’. This Asana is called so since during this Asana, the body is positioned like that of a dead person.



**METHOD :**

- 1) Lay on your back. There should be a distance between legs and feet. Hands too should be at a distance from the body.
- 2) Palms should be facing upwards and eyes are closed.
- 3) Breathe slowly in this position so that breathing can't be felt.
- 4) Head should be placed straight.

**BENEFITS :**

- 1) All muscles and veins are relaxed with this Asana.
- 2) It refreshes the body.
- 3) It releases exertion and mind become tension free.

**PRECAUTIONS :**

Those who are prone to depression and low blood pressure should not perform this Asana.

**b) MAKARASANA :**

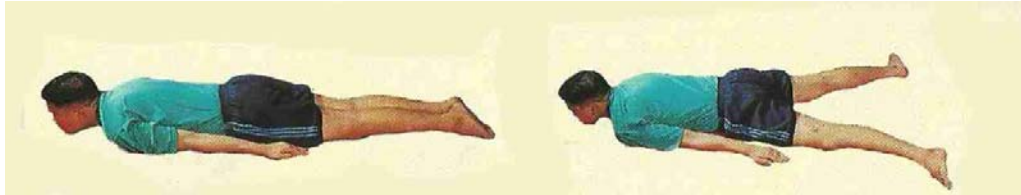

**METHOD :**

- 1) Lie on stomach on the ground.
- 2) Keeping distance in legs, the heels should be inwards and toes outwards. Ankles must touch the ground.
- 3) Fold arms and be positioned on elbows. Hold left shoulder with right hand. This way, both elbows will be on each other.
- 4) Keeping head on arms, breathe slowly.

**METHOD TO RELEASE :**

- 1) Take the right hand off the left shoulder and take it back to the right side.
- 2) Take the left hand off the right shoulder and take it back to the left side.
- 3) Reducing distance between the feet, come back to the original position.

**BENEFITS :**

- 1) It provides peace to the body and mind.
- 2) It releases burden and stress on the brain.
- 3) It is beneficial for breathing and organs of the digestive system.
- 4) It improves blood circulation too.

### 3) CULTURAL ASANAS :

#### i) Pawan-Mukta Asana :

In the Sanskrit language, the word 'Pawan' means 'Air' and 'Mukt' means 'Free'. Therefore, it literally means to release the excess air from the body. This Asana is also called wind relieving posture.



#### METHOD :

- 1) Lie straight on your back.
- 2) While inhaling, take both knees close to the abdomen.
- 3) Hold knees with hands.
- 4) While exhaling, lift your head and touch chin with knees.
- 5) Then take the head back.
- 6) Take the hands off the knees.
- 7) While exhaling, straighten your legs.
- 8) Join feet and take hands and arms to the sides of the body.

#### BENEFITS :

- 1) It strengthens the digestive system.
- 2) It is helpful in curing constipation.
- 3) It cures acidity or gas related problems.
- 4) It reduces fat from around the stomach.

#### ii) Parvat Asana :

It is also called Mountain Asana. Body is positioned like a mountain in this. It means that body is stretched at the bottom and narrowed at the top.

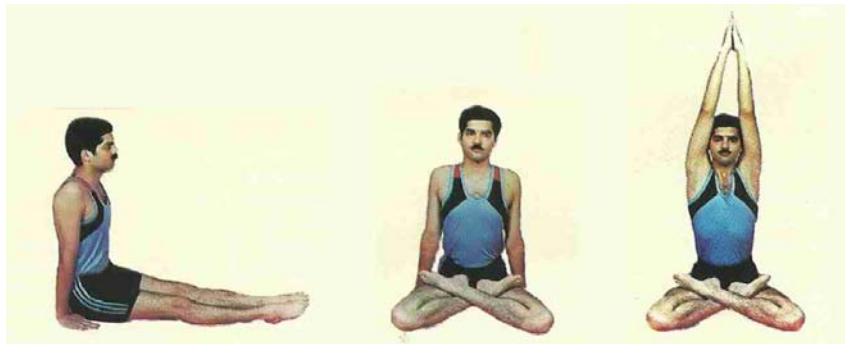

### **METHOD :**

- 1) Sit with spine straight in either Padam or Sukhasana.
- 2) While inhaling eyes should be closed and, take you both hands towards the head.
- 3) Join both hands above the head in the Namaskara position.
- 4) Slowly keep inhaling and exhaling.
- 5) Then while exhaling, take your arms down.
- 6) Repeat it for 4-5 times.

### **BENEFITS**

- 1) It is helpful in curing backache, shoulder pain and lower backache.
- 2) It strengthens legs and thighs.
- 3) It sets the digestive system right.
- 4) Long breathing act strengthens lungs which further cures our respiratory diseases.
- 5) It is helpful in reducing fat off the back and waist.
- 6) It releases mental stress.

### **4) PRANAYAMA :**

To set the breathing process of inhaling and exhaling in right

way. Pranayama imports oxygen to the brain. There are three types of Pranayamas:

1. Purak
2. Kumbhak
3. Rechak

Purak refers to inhaling, Kumbhak means to hold breath for some time and Rechak means exhaling. The types of Pranayama are as under:

- 1) Anulom-Vilom Pranayama
- 2) Kapalbhati Pranayama
- 3) Shitkari Pranayama
- 4) Bharamari Pranayama
- 5) Bhastarika Pranayama
- 6) Shitli Pranayama
- 7) Ujayi Pranayama

**5) PRATIHARA :**

Through Pratyahara, we can improve our concentration process. With the help of Pratihara, we can control our five senses-sight, hearing, smell, touch and taste. In case there is any problem with any of these senses, we cannot concentrate on any of our work. Hence, if we see anything bad, we keep concentrated on that for a long time and therefore, we cannot concentrate on our work.

**6) DHARANA :**

The sixth position of Ashtanga Yoga is called Dharana. It is done to relax the body and mind. In Dharana, we concentrate on one point for a long time. In the position of Dharana, our mind is completely at peace.

**7) DHYANA :**

Dhyana is the seventh part of Ashtanga yoga. Dhyana is derived from Sanskrit word 'Dhyani' which means 'thinking'.

**8) SAMADHI :**

Samadhi is the topmost position. During Samadhi, we concentrate our mind for a long time. In ancient times, saints and sages used to sit in Samadhi for a long span. With this position, we can control our brain.

Yoga Asanas help a lot in getting rid of multiple physical ailments. Flexible exercises of yoga Asanas help in reducing fat. Overall it can be concluded that we need to be well aware of the yoga. Since the very beginning, with the help of yoga activities, we can make our body strong and healthy. If we pay a deeper look into the benefits of yoga, we come to know that by performing yoga we became physically fit and mentally active and aware. Yoga can be adopted and practised at any stage of life. Even in the old-age, yoga proves helpful in keeping our muscles strong. We can attain a healthy or disease-free body through yoga.

**EXERCISE**

1. How many types of Asanas are there ?
2. Give definition, meaning and importance of Yoga.
3. What precautions are needed to be taken before performing Yoga?
4. What is meant by 'Surya Namaskara'? How many parts does it have in total?
5. Write in detail the method and benefits of any one Relaxative and Cultural asana.
6. Write detail about the parts of Ashtanga Yoga.

—0—

—(49)—

## LESSON - 5

# HARMFUL EFFECTS OF DRUGS AND DOPING

A man has been using drugs since ancient times. Earlier drugs were used as a medicine but with the passage of time, the medicines are used as a drug or stimulant. In this modern era, the man is badly affected by this bad habit of taking drugs. Unfortunately, youth is falling deep into the marsh of drugs. Students of schools, colleges and universities use drugs due to their bad company or just to raise their hollow pretence. Gradually, they become habitual of taking drugs and destroy their precious lives. These drugs are responsible for their behavioural, mental and physical downfall.

Even sportspersons are not spared from this curse in this advancing era. Some sportspersons use these fatal and banned drugs to attain name, fame and honour in short time, to achieve something big without working hard or to win a medal. These drugs gradually make the body of the sportsperson hollow inside. A number of diseases are the result of taking drugs which may end up with the death of the sportsperson.

### WHAT ARE DRUGS ?

A drug is such a substance that man loses his control over his brain after using it. His muscles become paralyzed and he does not feel any pain. He loses control over his mind and body and causes harm to his own family and the society.



## **KINDS OF DRUGS**

There are several types of drugs which are very common in the society like alcohol, tobacco, opium and other intoxicants.

### **1. ALCOHOL :**

Alcohol is such a liquid substance which is prepared after fermentation of grains or from acetic acids.

- a) Regular use of alcohol causes some major effects on the body. It damages the liver. The liver stops working which further causes liver diseases.
- b) Alcohol affects the digestive system because it directly attacks Pancreas.
- c) Pancreas helps to make insulin in the body. The sugar level increases in the body which further increases the risk of developing the disease of diabetes.
- d) Alcohol affects Central Nervous System (CNS) which destroys coordination between body and brain.
- e) When a person gets addicted to alcohol, he or she is affected by drowsiness, stress, high blood pressure, increase or decrease in the heart-beat and rhythm, snorting even after quitting it.
- f) Alcohol affects the heart of a person which increases the risk of heart diseases.
- g) Alcohol reduces the reproductive potential of a person.
- h) Alcohol weakens the bones of a person inside.
- i) Alcohol eliminates the power of a person to fight diseases.

### **2. TOBACCO :**

Tobacco is obtained from the leaves of 'Nicotiana' plant. But it is most used in the world for the purposes of chewing, drinking and

smelling. Tobacco smoke contains various poisonous combinations like Benzopyran, Formaldehyde, Cadmium, Gilt, Arsenic, Phenol and many more which are very harmful to human body. The usage of tobacco in public places was banned by the High Court in May 2004. The person who only receives the smoke of tobacco gets more affected than the one who actually uses it. May 31 is celebrated as Anti Tobacco Day by the WHO. According to 2010 statistics, 53% of deaths in India are caused due to diseases related to use of Tobacco.

### **FATAL EFFECTS OF TOBACCO ON THE BODY**

- a) The use of tobacco causes breathing, lungs, liver, pancreas, kidney, urinary bladder, oral cavity, nasal cavity problems.
- b) Tobacco causes lung and mouth cancer.
- c) It causes asthma and respiratory ailments.
- d) Because of the use of tobacco by women, nicotine gas has an adverse effect on the brain development of Embryo in the womb.
- e) Tobacco smoke contains tar, which gets deposited in the lungs like a gauge and destroys their whole functioning.

### **3. OPIUM :**

Opium is obtained from Papaver Somniferum plant. It is a black additive substance and is commonly also used as a drug.

### **FATAL EFFECTS OF OPIUM ON BODY**

- a) The person feels excited in normal circumstances too.
- b) Opium also affects their eye, which results in impairment of vision.
- c) The lips and nails turn blue.

- d) A person may experience chest pain.
- e) A person may experience the altered sensation of heat and cold.
- f) The person feels fear, apprehension and sickness.
- g) Any decision making ability decreases.
- h) The heartbeat becomes faster.
- i) The person may feel a headache.

#### **4. MEDICAL DRUGS :**

Many types of painkillers come under the medical drugs, which are given to the person for relieving the pain of an acute illness or accident. Sportspersons and non-sportspersons both are using them in their routine life. Such medicines include various types of dietary pills, cough syrups, muscle relaxants ect.

#### **FATAL EFFECTS OF MEDICAL DRUGS :-**

- a) They may cause abdominal and bowel diseases.
- b) The person experiences fever and nausea.
- c) Dryness and red spots appear on the body.
- d) An overdose of medical drugs damages the liver and can lead to the death of the person due to internal bleeding.

#### **5. OTHER DRUGS :**

Apart from these, many other drugs like smack, cocaine, charas are also used by sportspersons. Many school children, women, colleges students are losing their talent, energy, thinking power and social relations by falling deep into the swamp of these drugs. Students cannot control their emotions at their young age. In such cases, families, teachers and society can bring back these distracted students into the mainstream by showing concern and love towards them. There can be many reasons for drug addiction

among the students and by giving heed to these reasons, the curse of drugs can be get rid of.

## **REASONS OF DRUG ABUSE**

### **1. DEMONSTRATION OF EXISTENCE :**

Sometimes the student or the sportspersons is neglected by the parents, coach, teacher or the society. The child or the sportsperson feels that no one is paying attention to him, so they use such wrong methods of taking drugs to seek the attention of others.

### **2. UNEMPLOYMENT :**

Unemployment is also a major cause of this increasing trend of drug addiction when a well-educated young man or a young sportsperson does not get any employment, he becomes depressed. Due to depression, he starts using drugs to reduce his stress.

### **3. MENTAL DEPRESSION :**

Some young people are depressed due to mental stress, inability to face any problem. They take drugs to overcome their depression in such a situation.

### **4. LONELINESS :**

Sometimes both parents are working. There is a dearth of attention to their child. Quality time is not given to the child, or the child spends most of the time in the house alone. To overcome this loneliness he finds the support of drugs.

### **5. LACK OF KNOWLEDGE :**

Students become accustomed to these drugs due to lack of knowledge about the deadly effects of drugs.

**6. PEER GROUP PRESSURE :**

The student or the sportsperson is pressurized by his friends or peers for using the drugs for once. He is misguided that drugs are for fun.

**7. DESIRE TO KNOW :**

At an early age, the student desires to know every new thing in the house. If some drugs are used by a member at home, the child may also want to know about it. At first, he tries them stealthily but gradually falls into the grip of drug addiction.

**8. FOR FUN :**

The youth use these drugs for fun in parties for their own fun. It gradually becomes a habit.

**9. TO PROVE ONESELF SUPERIOR :**

Sometimes students are prevented by their friends or by their parents from doing any special work by being called ignorant or foolish which may cause them to unfair means to prove themselves superior in a fit of rage.

**10. MEDIA :**

Media warns youth against the use of drugs, but the students take it in other sense and misinterpret it. As the use of drugs is also highlighted in the films, songs and dramas, so they also take it as a symbol of fashion or status.

**EFFECTS OF DRUGS ON SPORTSPERSONS, FAMILY AND SOCIETY**

A drug is that substance which is used by a person causes him to lose. He not only spoils his health but also makes the lives of his family members difficult. He uses every wrong method to fulfill his demands for drug consumption. There remains a conflict in the family which has

an adverse effect on the children's growth and development. Everyone in the society remains away from such a drug addict.

## **DOPING**

The trend of doping is found more commonly among the sportspersons. Doping is a method of consuming certain medicines or methods that can increase sportsperson's performance. According to the International Olympic Committee, "Any such method or substance that is used by athletes to increase their performance is called Doping".

### **TYPES OF DOPING**

**Doping is of two types :**

- 1. By Physical Procedure**
  - 2. By Medicines**
- 1. BY PHYSICAL PROCEDURE :**

In this procedure, two types of doping are included.

### **BLOOD DOPING :**

In such a procedure, the haemoglobin count of the sportsperson is increased which gives more oxygen to the muscles this increases the sportsperson's performance. This method is used by long-run sportspersons. Blood doping is of two types.

- a. In the first method, blood or bone marrow from another person matching with blood group of the sportsperson is taken.
- b. The blood of the sportsperson is stored in the refrigerator and is infused in the body of the sportsperson few days before the competition. This gives his muscles more strength by which his performance increases. International Olympics Committee has banned it.

### **DEADLY EFFECTS ON THE BODY :**

- a. Sometimes when a sportsperson's blood is not matched with donor's blood or
- b. germs of some deadly disease of a person may enter the sportsperson's body or a
- c. an infection can also occur in the blood kept in the refrigerator which can cause chronic diseases and cause serious infection which may also lead to death.

#### **e) Gene Doping**

Gene doping is the hypothetical non-therapeutic use of gene therapy used by a sportsperson in order to improve their performance or treatment. In this type of doping, sportspersons' genes are modified to enhance their physical ability. But it is not yet proved whether this method has been used by anybody. It increases muscular development, the rate of making blood, tolerance and strength to bear more pain. Gene doping is described by World Anti-Doping Agency (WADA), but the method of testing it, is not yet available.

### **2. THROUGH MEDICINE :**

Different types of medicines are used to increase performance in this type of doping. These medicines are used by athletes, bodybuilders, gymnasts, weightlifters, ect. These also include stimulants which are intoxicated medicines increase brain stimuli and accelerate physiological functioning. These medicines include Caffeine, Cocaine, Amphetamine, Anabolic Steroids, Narcotics, Erythropoietin, Diuretic drug ect.

#### **a. Amphetamine**

This is a potent Central Nervous System stimulant which is mostly used in the treatment of attention deficit hyperactivity,

disorder, narcolepsy and obesity. It stimulates the brain, accelerates blood circulation and respiratory system thus increases concentration and physical strength. This drug is mostly used by shooters and archers.

**Bad Effects on the Body :**

- i. The nature of the sportsperson remains irritability.
- ii. Impairment of eyesight.
- iii. Drowsiness.
- iv. It affects the rhythm of the heartbeat.

**b. Caffeine**

Caffeine is a substance that is commonly used and is present in soft drinks, coffee, tea, coca-cola, chocolate ect. It is found in the medicines which increase neuronal-activity.

**Bad Effects on the Body :-**

- i. Muscles become so dependent on caffeine in such a way that if the person does not use it, his body feels lethargic.
- ii. It affects the brain.
- iii. Heartbeat becomes faster.

**c. Cocaine**

Cocaine is made from the leaves of the cocoa plant and is best known by the name of coke. It stimulates our mental system and mostly used by the athletes of long-race.

**Bad Effects on the Body :**

- i. A person's memory is reduced.
- ii. Heartbeat becomes faster.
- iii. Pupils of eyes get affected, which reduces eyesight.



- iv. Sports person suffers from high blood pressure.
- v. The body temperature increases.

**d. Narcotics**

These are the substances that affect the functioning of human body. Man feels drowsy after taking these plant substances like Ganja, Opium, and Hemp whereas, substances like Brown Sugar, Heroin, Morphine are made from chemicals like carbon, hydrogen, nitrogen ect.

**Bad effects on the body :**

- i. Muscle become tense and does not return in resting condition easily.
- ii. Most people go into depression after consuming it.
- iii. Eye diseases occur.
- iv. Using syringe used syringes leads to AIDS or other chronic diseases.

**e. Human Growth Hormones :**

The hormones are produced by the Pituitary Gland in the brain's base. These hormones help in human growth and development. This increases the cartilage cells that cause the growth of bones and muscles. This increases the sports person's sports performance.

**The Deadly Effects on the Body :-**

- i. There is a risk of developing diabetes.
- ii. Heart diseases occur.
- iii. Sports person suffers from muscle, joint and bone pain.
- iv. The person lives in stress.

- v. Due to the random increase in the length of the limbs, the body looks disfigured.

**f. Diuretics**

This banned drug is used by the sportsperson to reduce his body weight. By doing so, the sportsperson can play under the lower weight category.

**Deadly Effects on the Body :-**

- i. The body's strength continues to reduce due to rapid weight loss and this weight loss affects kidneys.
- ii. The liver of the sportsperson gets destroyed.
- iii. The digestive power is affected.
- iv. After using it, the sportsperson does not have enough time to recover, which makes him lose the game.

**g. Insulin**

Insulin increases the amount of glycogen in the muscles. This can be used as an energy source by the athlete in an event where he needs more tolerance.

**Bad effects on the body :-**

- i. Blood sugar level decreases.
- ii. Loss of concentration.
- iii. Some veins in the brain may rupture.
- iv. The person may suddenly fall sick.

**INTERNATIONAL OLYMPIC COMMITTEE**

The medicine or drug or substance which increases the sports performance artificially are banned by the International Olympic Committee. 1001 dope tests were conducted by the International

Olympic Committee during London 2012 Olympic Games and 100 sportspersons in these tests were found to have used banned substances, including the Albanian weightlifter Hassan Pulaku, who tested positive for anabolic steroid. The Committee has banned all such substances which enhance the performance artificially of the sportsperson and also affect his health. The game spirit is hurt. Strict action is taken against those practicing banned medicines. Medals are taken back from the sportsperson and he is banned for playing.

### EXERCISE

1. Which Drugs are commonly used by people in the society ?
2. What are Drugs ?
3. What are different kinds of Drugs ?
4. Write a note on Tobacco ?
5. Write about the fatal effects of using Opium on our body ?
6. What are reasons of taking Drugs ?
7. What are the bad effects of using Drugs on a player, family, society and country ?
8. Write a note on the International Olympic Committee ?

—0—

—(61)—

## LESSON - 6

# SPORTS PSYCHOLOGY

In this modern era, new inventions are being made in every sphere of life, and also in the field of sports. Sportspersons are soaring new heights and setting new records in national and international level sports. If we glance at the sports performances performed during last two-three decades, we come to know that the record set by sportspersons at the international level could not be broken by other players for a long time. But now a days players are doing hard work through the use of scientific principles and techniques; thus they are continuously achieving new goals and setting new records. Psychology, as a science of behaviour, has proved to be helpful in improving the performance of the players. With the help of psychology, the demerits or shortcomings of a person's can be removed by observing their behaviour. A physical education teacher or coach must have the knowledge about principles of Psychology so that after performing an analysis of the behaviour or emotions of the player, he or she might enable to give good results.

### MEANING OF THE SPORTS PSYCHOLOGY

The term, "Sports Psychology" is a combination of three words "sports+psyche+logos". 'Sports' means an activity involving physical exertion and skill in which an individual or team competes against the other. 'Psyche' means mind or soul and 'logos' means science. This means that sports Psychology is a science that studies human behaviour during sports training and competitions.

A sports psychologist acts like the backbone of a sportsman and gives them instructions to make the performance impressive and successful. He does not allow the sportsperson's morale to fall or collapse during a competition or training; rather he makes them mentally fit and creates a positive attitude among them, which results in the enhancement of the sportsperson's fitness and activity. The main objective of a sports psychologist is to improve the performance of the sportsperson by enhancing his mental fitness, the determination of their behaviour, and control over their emotions.

Besides this, Sports Psychology also a branch of Psychophysiology which is related with the psychoactive branch that is related with the subjects like biomechanics, kinesiology, sports physiology, sports medicines etc. through which the sportsperson's physiological behaviour is assessed and physical and mental fitness can be improved by promoting sportsmanship and sporty attitude.

### **DEFINITION**

### **SPORTS PSYCHOLOGY**

#### **ACCORDING TO BROWN AND MAHONEY**

“The sports psychology is the application of psychological principles to sports and physical activity, at all levels.”

#### **ACCORDING TO SINGER**

Sports Psychology involves all those branches of Psychology which are related with our capacity or ability to understand the performance of an athlete, improve it and to take a pleasant psychological advantage of experiences gained from various programme of sports and exercises.

### **ACCORDING TO EUROPEAN UNION OF SPORTS PSYCHOLOGY**

“Sports Psychology is the study of the Psychological basis processed and effect of sports.

From the above definitions, it can be concluded that sports Psychology analyses the mental level and behaviour of the sportspersons while they are following the game rules and principles of a game.

### **SCOPE OF SPORTS PSYCHOLOGY**

Sports and Psychology have a close mutual relation. Sports Psychology prepares sportsperson mentally and physically through sports activities and by analysing his behaviour. That is why mind and body are defined as two sides of a coin that cannot develop without mutual support.

Sports Psychology is a branch of Psychology that promotes the performance of sportspersons by observing their behaviour, individual differences, environment, and phases of development, sports personality, intellect, learning processes, and their self-analysis. It also includes lodging, food, environment, sports goods, psychological appearance, social relations etc.

### **BRANCHES OF SPORTS PSYCHOLOGY :**

1. Sports Organization Psychology
2. Educational Psychology
3. Health Psychology
4. Developmental Psychology
5. Medical and Clinical Psychology
6. Exercise Psychology
7. Social and Group Psychology

## **PSYCHOLOGICAL FACTORS AFFECTING SPORTS PERFORMANCE**

Every person dreams that he should be an expert in every sphere of his life. Similarly, when a sportsperson starts playing, his aim is to become a prominent sportsperson in his life and he can be made a mentally strong sportsperson by controlling his negative aspects and producing positive energy in him. Its main aim is to overcome the sportsperson's emotions and to make him strong and tolerant. The following are the main factors that affect the sportsperson's sports performance: -

### **1. BEHAVIOUR :**

It is evident that man is a social animal and he enjoys his life with the quality of his behaviour right from his birth till death. All aspects of behaviour e.g. consciousness, unconsciousness, socialism, morality and immorality influence sportsperson's performance. However, the game should be chosen by taking into account of the nature and interest of the sportsperson, so that he can perform well during the game. By conditioning the behaviour of the players qualities like determination and tolerance can be inculcates in them.

### **2. EMOTIONS :**

Man is a puppet in the hands of emotions. Emotions are those mental processes that come in the form of happiness, grief, fear, anxiety, nervousness, anger and frustration in the conscious and subconscious mind. These feelings come in the form of symptoms and reaction like paling of complexion, sweating, hormonal changes, tremors etc. in the body. Sometimes sportsperson cannot perform well because of emotional stress. Sportspersons can change their behaviour and improve their sports performance by controlling these emotions.

**3. HEREDITY :**

Physical characteristics such as height, weight, a colour of eyes and skin, social and intellectual behaviour are determined by heredity. Mental aspects of heredity can be seen in the form of intelligence, memory, imaginative strength, thinking and emotions like fear, anger, stress and anxiety. Heredity is considered as the main cause for the best performance of a sportsperson because a child acquires physical, mental and emotional traits from heredity only. These traits make a sportsperson an expert in his game. For example, Leila Ali is the world's leading boxer, because her father Muhammad Ali was also a great boxer, and there are so many examples that show that this trait continues for generations.

**4. ENVIRONMENT :**

The surroundings of man are called environment, in which he spends his life and fulfils his needs. There is a strong influence of environment on the behaviour of a sportsperson. In order to produce good sportspersons, they should be provided with a healthy sports environment, so that they can concentrate on sports.

**5. MOTIVATION :**

Motivation is a resource that creates passion and interest for training and performance in a sportsperson. It also makes them keen to play their game. This enthusiasm or excitements are produced naturally or artificially in a sportsperson by motivating him. It creates desire and interest in him towards an activity and he becomes busy in practicing and doing that activity continuously for several hours. It is such a power that also eliminates the hunger and thirst of a sportsperson. It creates in him an increased appetite and desire for doing better. Motivation increases confidence in a sportsperson.



**6. MENTAL HEALTH :**

Psychology is the science of behaviour and mental processes. Mental processes are caused due to mental activities, which are found in the minds of the sportsperson's brain in the form of right thinking, memory, imaginative intellectual powers, belief and reasoning. It also includes wishes and emotions. They help the sportspersons to reduce their mental problems and raise their mental level. In order to keep the sportspersons conscious of their mentality, Sports psychologists have researched clinical therapies, meditation and other rigorous activities to keep the sportspersons mentally fit and healthy. By this method, the emotions of the sportspersons are pacified and controlled, so that they can make the right decisions their competitions and perform better in the same.

**7. INDIVIDUAL DIFFERENCES :**

Every living being has variations in terms of colour, form, size and weight from the other. These differences are responsible for differences in physical, mental, intellectual, and emotional aspects of the sportsperson, which in turn make them different from one another. In the field of physical education, sportspersons are encouraged to select their games by considering these differences, for example, games like basketball, handball games require tall sportspersons; wrestling and weightlifting need heavyweight sportspersons with strong determination and offensive in nature; whereas, shooting and archery sportspersons with powerful concentration can be benefitted.

**8. PERSONALITY :**

The behavioural pattern of any sportsperson depicts his sports personality. It is a major factor that identifies individual

characteristics of a sportsperson like physical, mental, emotional, intellectual and social form. It also creates an identity of a sportsperson in the society. Experience, learning and training process are the main factors that enhance the sports personality of a sportsperson. This leads the sportsperson to give good performance and make him popular in the public which makes him a role model for other sportspersons. The process of sports personality development occurs easily in a sportsperson who takes part in sports and games.

#### **9. DETERMINATION :**

Every person starts his day with a specific goal and objective in his mind. The goal of a common man is to earn money for his life so that he can meet the needs of his family and himself. This determination helps him in strengthening his behaviour to keep going while facing all odds. Same way the stability of sportspersons behaviour develops determination, encouragement, tolerance, self confidence and makes him a strong contender.

#### **MOTIVATION**

Motivation is a force that inspires the sportspersons to work, act and instigate for better performance and constantly make efforts to achieve their goal. It is a resource that arouses immense interest among the sportspersons. That is why the sportspersons continue to practice despite many disappointments. Excitement and emotions give the power to play; this acts as a source of a powerful form of energy and does not let the sportsperson to feel tired.

Motivation influences the general patterns of sports behaviour of the sportspersons, indicating and directing them to a practical form, improve them and gives birth to a new hope of success. It can also be the outcome of physical, psychological, congenital and environmental

factors that motivate a sportsperson to do activities and keep on molding according to a specific pattern.

The word “Motivation” word has been derived from the Latin word ‘Movere’ which means “to walk” or “to move” This means that by changing the behaviour of a sportsperson can be made to move towards his goal. Because motivation plays an important role in the process of learning, that is why it is also called the Heart Of Learning. Motivation develops the hunger for learning in a sportsperson and inspires him to accomplish the desired objectives. Without motivation, the ability of a sportsperson becomes futile even if he is full of self-confidence, intense desire and emotions to do something. Hence, motivation is of great importance for achieving any kind of success in life.

### DEFINITION

“Motivation is considered with the arousal of the interest in learning and to that extent, is basic to learning.” *Crow and Crow*

“Motivation is the central factor in the effective management of the process of learning, some type of motivation must be present in learning”. *Kelly*

“Motivation refers to state within a person or animal that drives behaviour towards some goal.” *Morgan and King*

“Motivation can be defined as any condition that might energize and direct our actions.” *Crooks and Stein*

“Motivation is an internal factor that arouses, direct and integrates a person’s behaviours.” *Murry*

“Motivation is the direction and intensity of behaviour.”

*Elizabeth and Duffy*

Motivation is the process of teaching, coaching, learning and training which inspires a sportsperson to make his behaviour stable for

the optimum performance. It helps human being satisfy his inner tendencies.

### **TYPES OF MOTIVATION**

A sportsperson is always motivated to meet his needs because it helps him to achieve his goal easily. It is the main factor which a sportsperson makes use of while moving towards his goal or destinations are called as stimulus or stimuli. Motivation is of two types.

1. Internal or Intrinsic Motivation
2. External or Extrinsic Motivation

#### **(1) INTERNAL OR INTRINSIC MOTIVATION :**

Internal or intrinsic motivation is such a motivation that creates the craving, interest and desire in a sportsperson to do something. It is a congenital process that satisfies one's inner feelings. They are inborn and remain from birth to death, such as hunger, thirst, sleep, hatred, entertaining, playing etc. To satisfy these basic needs, a sportsperson lives in the society and participates in sports. The inner motivation is the internal yield of a particular sportsperson. It gives spiritual comfort to the sportsperson in the physical and mental form. It is classified as the following:-

1. Physical Motivation : lust, thirst, sleep, hunger.
2. Social Motivation : support, social needs.
3. Emotional Motivation : success, defeat, love, security.
4. Natural Motivation : trust, self esteem, interest, obligations etc.

#### **(2) EXTERNAL OR EXTRINSIC MOTIVATION**

External or extrinsic motivation encourages an individual through secondary factors. They have a great importance in the learning process especially in physical education and sports,

which are such social and psychological resources that are produced in an artificial way according to the needs of physical and mental satisfaction so that the sportsperson can concentrate on his or her mission. These motivations are made to induce a sportsperson e.g. guidelines, rules, instructions etc. that fulfil the physical and mental needs of an individual. Besides sportspersons are prepared for the game by giving them economic and social benefits, so that they can be encouraged to perform their best. The extrinsic stimulus is as follows:

1. Reward
2. Punishment
3. Competition
4. Examination
5. Audio-visual material for listening-viewing
6. Relationship between the coaches and the sportspersons
7. Support
8. Good environment and sports facilities
9. Stipend
10. Appreciation
11. By bringing innovations into the curriculum
12. Making training interesting
13. Self assessment

### **ROLE OF MOTIVATION IN PHYSICAL EDUCATION AND SPORTS**

Motivation is an essential quality for an effective and amazing performance, which makes the difficult activities easy for the sportspersons. The motivating factors may be a compliment to the sportsperson, praise or applause in a loud voice or patting on his back.

Motivation improves and enhances a sportsperson's performance that develops and provides energy for, and accelerates his behaviour to achieve the selected goal. It is a study of the achievements and lifestyle of renowned athlete or sportsperson, out of which new sportspersons are born.

**1. SUCCESSFUL PERFORMANCE :**

Successful performance motivates a sportsperson to continue his training after the series of failure. Though physical, mental, social, and economic factors also influence the sportsperson for a great and successful performance, curiosity, stimulus and interest influence on the successful performance of the sportsperson the most. Physical Education teacher and coach present the physical activities in a simple and interesting manner before the learner so that they can easily learn the activities and get continuous success.

**2. SATISFACTION OF THE BASIC TENDENCIES :**

Sportspersons find different opportunities for the fulfillment of their desires like hunger, thirst, sleeping, sports participation and training. The tendency of sports participation is primarily present in every sportsperson and he tries to fulfil them in his conscious or subconscious form. He is motivated to play by using natural resources and he takes all possible positive steps to satisfy his basic tendencies.

**3. POSITIVE ATTITUDE :**

Motivation brings positivity in the sportsperson's behaviour; hence the sportsperson follows the rules and principles of the game. He learns attributes like discipline and hard work which make his behaviour positive. This leads to an increase in his social relations. Sportspersons have cordial relations with everyone and people seek support from them.

**4. DEVELOPMENT OF SOCIAL RELATIONS :**

Motivation develops the sportsperson's social relations. When the sportsperson goes to play on the playground, he develops relations with sportspersons, coaches and different people of the society there. During the games, he is influenced by the lifestyle and culture of other sportspersons. They try to get involved with good sportspersons. He develops social relations with them by using natural and artificial methods of motivation.

**5. DEVELOPMENT OF TOLERANCE :**

A sportsperson goes through different situations while playing in the playground and during training. Each sportsperson comes into the playground with the spirit of victory, but when he loses his feelings are hurt. At this crucial time, it is very important to understand his feelings. If so, is not done, then the sportsperson can become mentally upset and may lead to severe mental block that can ruin his performance. The coach tries to control over his disappointments by using motivational methods and this works as an energy for the sportsperson and develops his patience and tolerance.

**6. DEVELOPMENT SELF-ESTEEM IN TEACHERS AND COACHES :**

Coach, physical education teacher and sportsperson are the pivots of physical education and sports. Their mutual understanding, concentration, tolerance, coordination and co-operation that help them all to develop and perform better and lead them to self-esteem and satisfaction.

## CONCLUSION

From the study of the above statements, one comes to know that by using the sources of inspiration, good performance can be hoped or expected from players. The player can be mentally and physically prepared for competition. In conclusion, motivation and motivators play a significant role in the lives of players, teachers, coaches, trainers and Physical Education teachers and the two (motivation and motivators) groom the personalities of both the players and the coaches.

## EXERCISE

1. What are those three words combined in Sports Psychology ?
2. Write definition of Sports Psychology.
3. What is the importance of Sports Psychology in today's scenario ?
4. What is Motivation? Explain its sources in detail.
5. Explain the various branches of Sports Science.
6. Explain in detail the factors that affect sports performance.

—0—

—(74)—



## TOURNAMENT

The dictionary meaning of tournament is "a sports competition or a series of contests between the number of teams and a series of games in which a number of teams compete against one another according to a fixed schedule." At the end, the winner is decided.

Points to remember during the conduct of tournaments:

1. There should be enough time to conduct the tournament
2. The provision for the required equipment of games should be managed in advance.
3. The number of teams taking part in the tournament. The information about those teams should be collected beforehand.
4. The amount of money to be spent on sports competitions should also be fixed beforehand so that there is no disruption in the tournament due to lack of funds.
5. Qualified managers and the officials are needed to conduct the tournament properly. They should be arranged in advance.
6. Depending on the level of the tournament, different committees should be formed so that every officer or employee should know his responsibility regarding his duty.

These sports competitions which start from within the premises of an institution, school or college are organized up to the International level.

### **Intramural Tournaments**

All the tournaments, which are organized within the premises of an institution, school or college and in which the means students of the same class or house compete for their respective classes or houses, are called intramural tournaments.

The advantage of intramural sports competitions is that almost all the students of the institution or school or college participate in this. Students are divided into different groups or houses according to their role numbers. These competitions improve the basic ability of the students.

In any sports competition the organisers have to keep in mind the time required for the game and the type of competition Internal or Intermural sports competitions can be held at any time in year, but the best option is to conduct intermural competitions before outdoor tournaments and thus select the team of the institution.

### **Extramural Tournaments**

The Tournaments that are held between different organizations, schools or colleges are called Extra Mural tournaments.

### **Types of Tournaments**

There are several types of tournaments, some of which are as follows: -

1. Knock Out Tournaments or Elimination Tournament.
2. League or Round Robin Tournament.
3. Combination Tournament.
4. Challenge Tournaments.

#### **1. Knock-Out Tournament or Elimination Tournament**

It is also known as the elimination tournament. In this tournament, the team that wins the match plays the next match and the team that is defeated gets eliminated from the tournament. Matches of the teams are fixed by drawing lots one the Knockout tournaments. These events cost

less time and money. But one drawback of this type of tournament is that many a time the good team gets eliminated from the tournament in the early round.

Following are the types of Knock Out tournament:

- (i) Single Knock Out Tournament or Single Elimination.
- (ii) Consolation Tournament.
- (iii) Double Knock Out or double elimination Tournament.
- (iv) Bagnall Wild Tournament.

### **Method to fix the draw in a Single Knock out Tournaments:**

Following points should be remembered before making a fixture in a knock out tournament :

1. Total number of teams participating in the event.
2. Total number of byes to be given in each half.
3. Total number of teams to be taken in each half.
4. Total number of teams which have taken part in the tournament.

First of all two halves of teams will be formed,

the formula for which is as below:

$N = \text{Number of teams.}$

$$\frac{N+1}{2} = \text{(upper half)}$$

$$\frac{N-1}{2} = \text{(lower half)}$$

For example N = 9

$$\frac{N+1}{2} = \frac{9+1}{2} = \frac{10}{2} = 5 \text{ (Upper half)}$$

$$\frac{N-1}{2} = \frac{9-1}{2} = \frac{8}{2} = 4 \text{ (Lower half)}$$

**Note**

If the no. of teams is in the power of two ( $2^2$ ).

Then the teams are divided into half. For example 2,4,8,16,32 etc.

	Fixture of Even Teams		Fixture of Odd Teams
	1		1
Upper Half	2		2
	3	Upper Half	3
	<u>4</u>		4
	5		<u>5</u>
6	6		
Lower Half	7	Lower Half	7
	8		8
			9

If the participating teams in the tournament are the Power of Two ( $2^2$ ) as 2, 4, 6, 8, 16, 32, 64. In this case bye(s) shall not be given. If the number is not Power of two ( $2^2$ ) then this fixture should be made by giving a bye only for example 3, 5, 6, 7, 9, 10, 11, 12, 14, 18 etc.

Bye is an advantage given to a team that is exempted from playing in that first round. Bye is given by drawing a lot. Making a fixture is easy. If the number of teams is the Power of Two ( $2^2$ ), then there is no need to give a bye to any team. But if the number of teams is not Power of Two ( $2^2$ ), then there is a need to give bye. We have to see how many byes should be given and by which method.

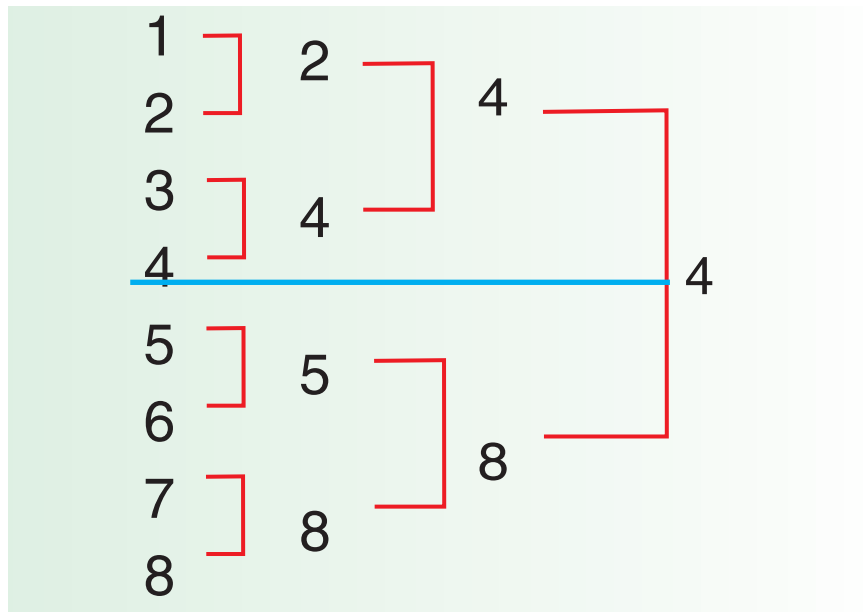

In the above fixture, no team has been given bye because the number of teams is in the Power of Two ( $2^2$ ). Similarly, if the numbers of teams are 11 then the number of teams playing in the first half will be =6

and in the second part is =5

$$\text{Number of Byes of Upper half} = \frac{\text{Total no. of byes} - 1}{2}$$

$$\text{Number of Byes of Lower half} = \frac{\text{Total no. of byes} + 1}{2}$$

Now question rises about the number of byes to be given if there are odd teams.

Total teams (N=11)

Next even number ( Next in Power of Two)  $2 \times 2 \times 2 \times 2 = 16$

(Even Number 4, 6, 8, **16**)

Total number of teams in this fixture = 16 (16-11) = 5 byes will be given.

**Methods to Give Byes**

If this tournament was held last year, then bye should be given to its first and second position holder or winner teams by putting them in separate halves. The remaining byes will be given by lot system.

**Method of Giving Byes:**

**Byes should be given by lots.**

1. The first bye should be given to the last team of the second half.
2. The second bye should be given to the first team in the first half.
3. The third bye should be given to the first team of the second half.
4. The fourth bye should be given to the last team of the first half. In this way, byes should be given.

For example, if 11 teams are participating in the tournament, then byes will be given in the fixture as follows :

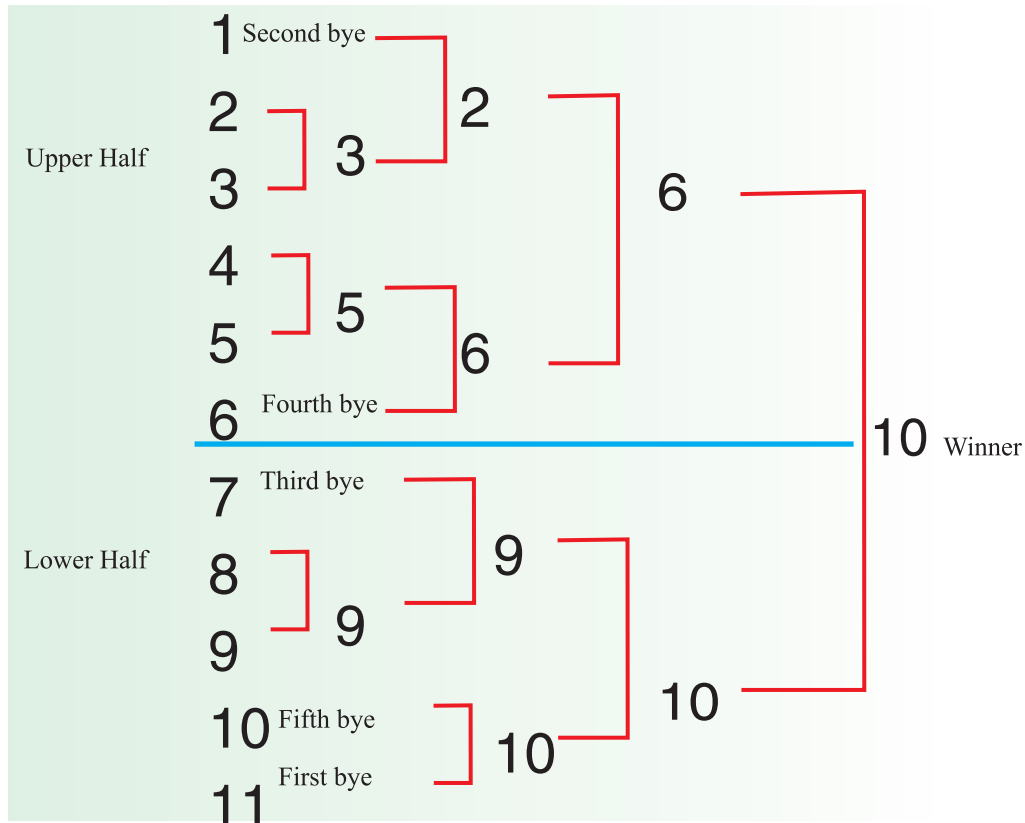

This method is usually used in a tournament of schools and colleges.

### **Merits of Single Knock Out Tournament-**

1. These tournaments finish in a less time and cost less.
2. All teams play enthusiastically because of the fear of Elimination.

### **Demerits of Single knock-out tournaments**

1. There is a possibility of elimination of a good team in this competition and possibility of weak teams entering in the final. If a good team is eliminated in the first round, the interest in the tournament is lost and the show of the remaining matches faints in itself.
2. As fixtures are made through lots, there is a possibility of good teams competing in a first round. If a good team is eliminated in a first round only, then the performance of the other matches does not prove good.

### **Seeding:**

This method is adopted to rule out the possibility of entry of good teams in the first round. Seeding is the sorting of teams and fitting them in the fixtures at the right place. The first four winning teams of the previous tournament are placed suitably in the fixture. The seeding teams do not play matches in the first round. Seeding number generally remains an even number. For example 2, 4, 8,10. etc. All the teams except seeding teams are placed in the fixture by lots. Byes are usually given to the seeding teams only.

If 11 teams are participating then  $16 - 11 = 5$  byes will be given. Four byes are to be given to seeding teams.

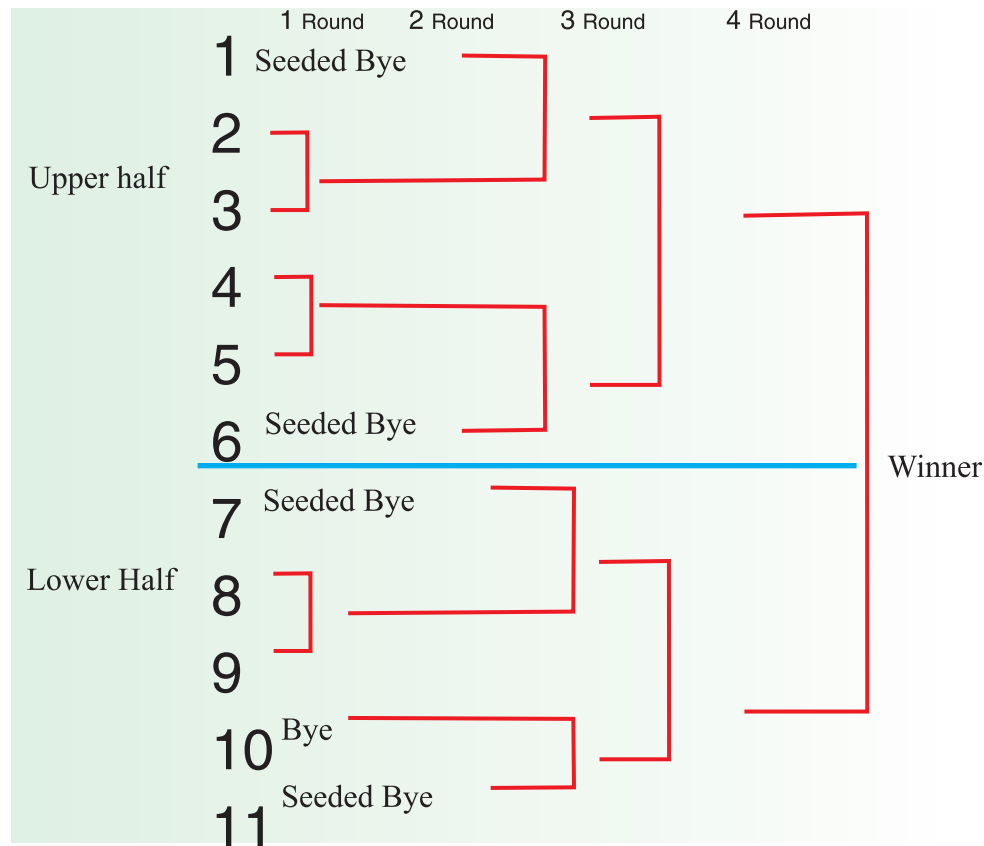

Seeding can be done only when the tournament committee is aware of the status or level of the teams. There are two types of seeding:

1. **Common Seeding**
2. **Special Seeding**

Common Seeding is given in the first round. Special seeding is given to the teams holding first four positions holder teams of the previous year which are given entry at the final or semi-final stage. Although this method seems to be partial and unjust, yet, it proves to be in favour of the overall success of the tournament.

### (ii) **Consolation Tournaments**

Sometimes good teams get eliminated from tournament due to some reason in the very first round. Weaker teams get chance to come forward as the good teams do not get chance to play again. Consolation tournament is



arranged to overcome this drawback. Consolation means to give the defeated team another chance to play so that it can prove its worth. The number of matches in the consolation tournament is more. This tournament is better than a single knock-out tournament. There are two types of this tournaments.

**Consolation Type 1:**

In this, every team gets a chance to play twice. The teams that lose in first round, compete among themselves. In consolation tournament, byes are given to those teams, which have not the same in Regular Knock Out.

For Example :

Total number of teams 13 teams.

Total numbers of Byes  $16-13 = 3$  teams will be given byes.

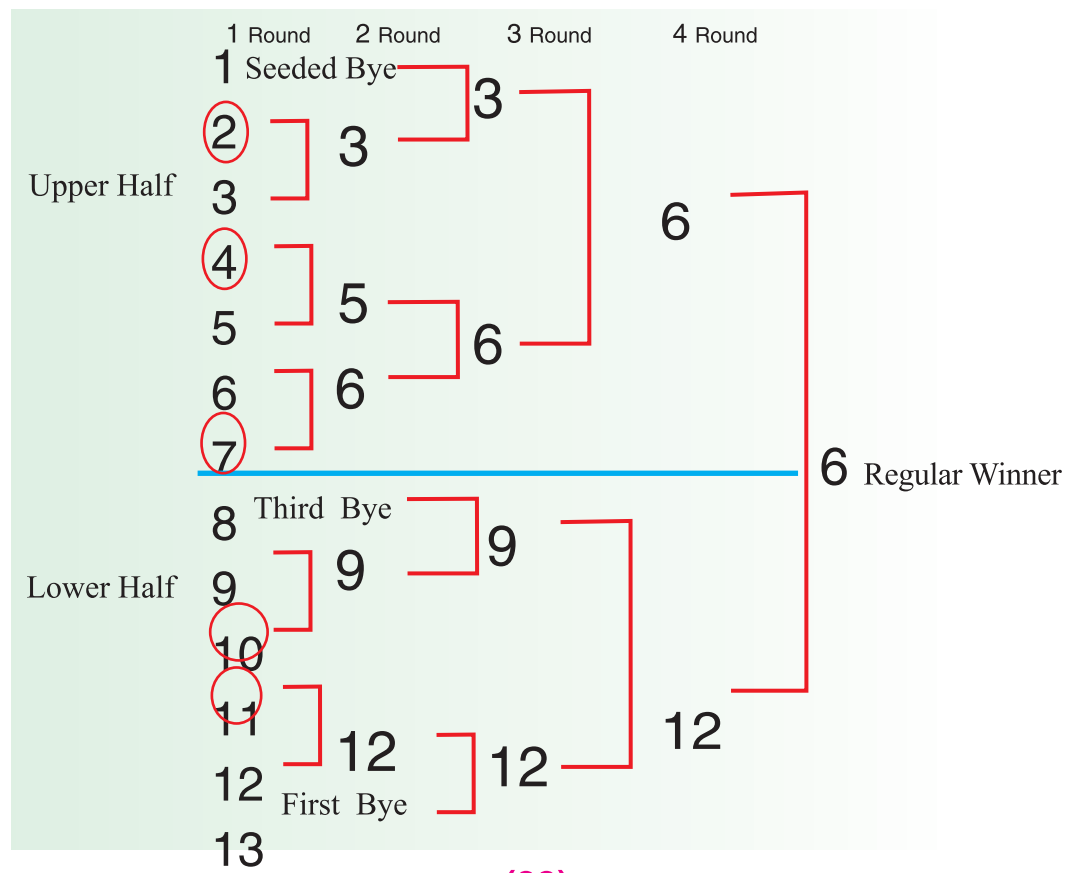

### Consolation Tournament of the teams losing in the first and second rounds

A draw of consolation for seven teams ( 2, 4, 7, 8, 10, 11, and 13) that have lost in the first and second rounds.

Total no. of Teams = 7

Byes =  $8-7 = 1$  team will be given bye.

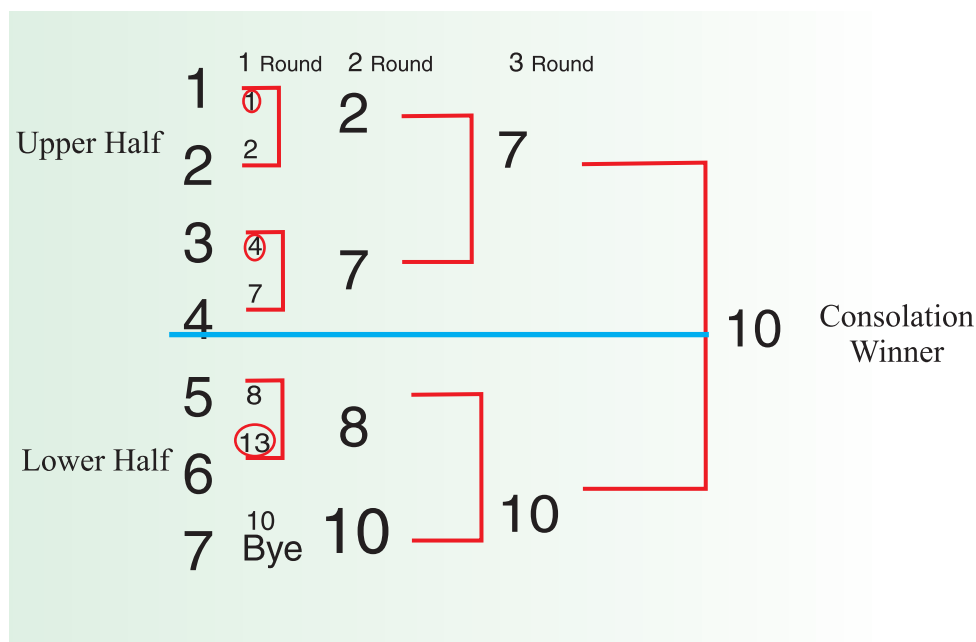

### Consolation Type 2

In the second type of consolation, the loser teams are given a chance to win. In this, the teams losing in the first round will compete among themselves, and the teams winning in the same will compete against those losing in the second round.

For example fixture of 8 teams.

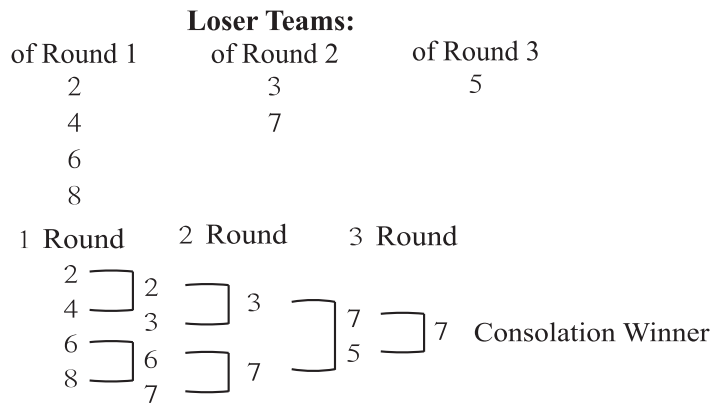
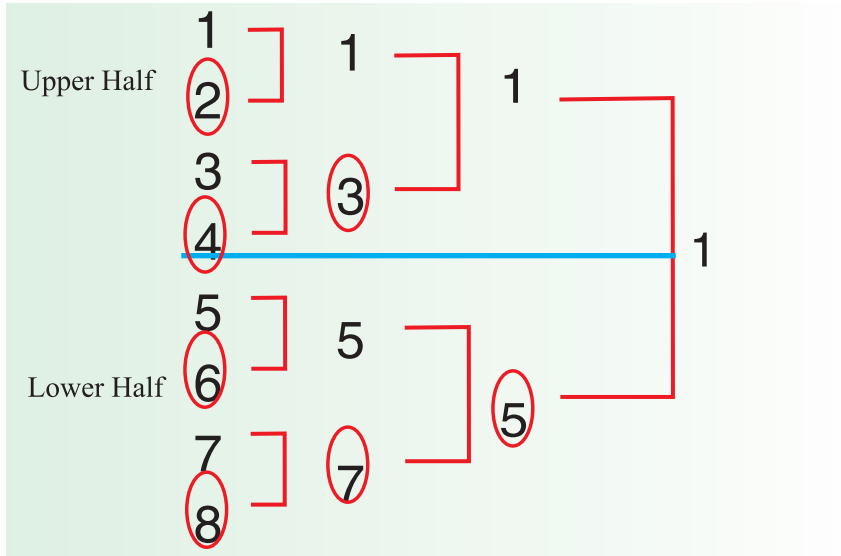

Consolation Type - 2, the winner of the tournament gets second place after the winner of the regular tournament.

This tournament is considered to be an extension of the consolation tournament. The winner of the regular tournament plays with the winner of the consolation tournament to decide for the true champion. This tournament is meant to be continued for a long time until all teams, except one team, has been defeated twice.

Rounds for defeated teams in Consolation tournament:-

**(iii) The Double Knock-out Tournament**

This tournament is considered to be an extension of consolation tournament only. The winner of the regular tournament plays with the winner of the consolation tournament to decide the champion. This tournament meant to be continued for a long time until all teams, except one (team), have been defeated twice. This means if a team is to be declared out of the tournament, it (team) will lose it twice.

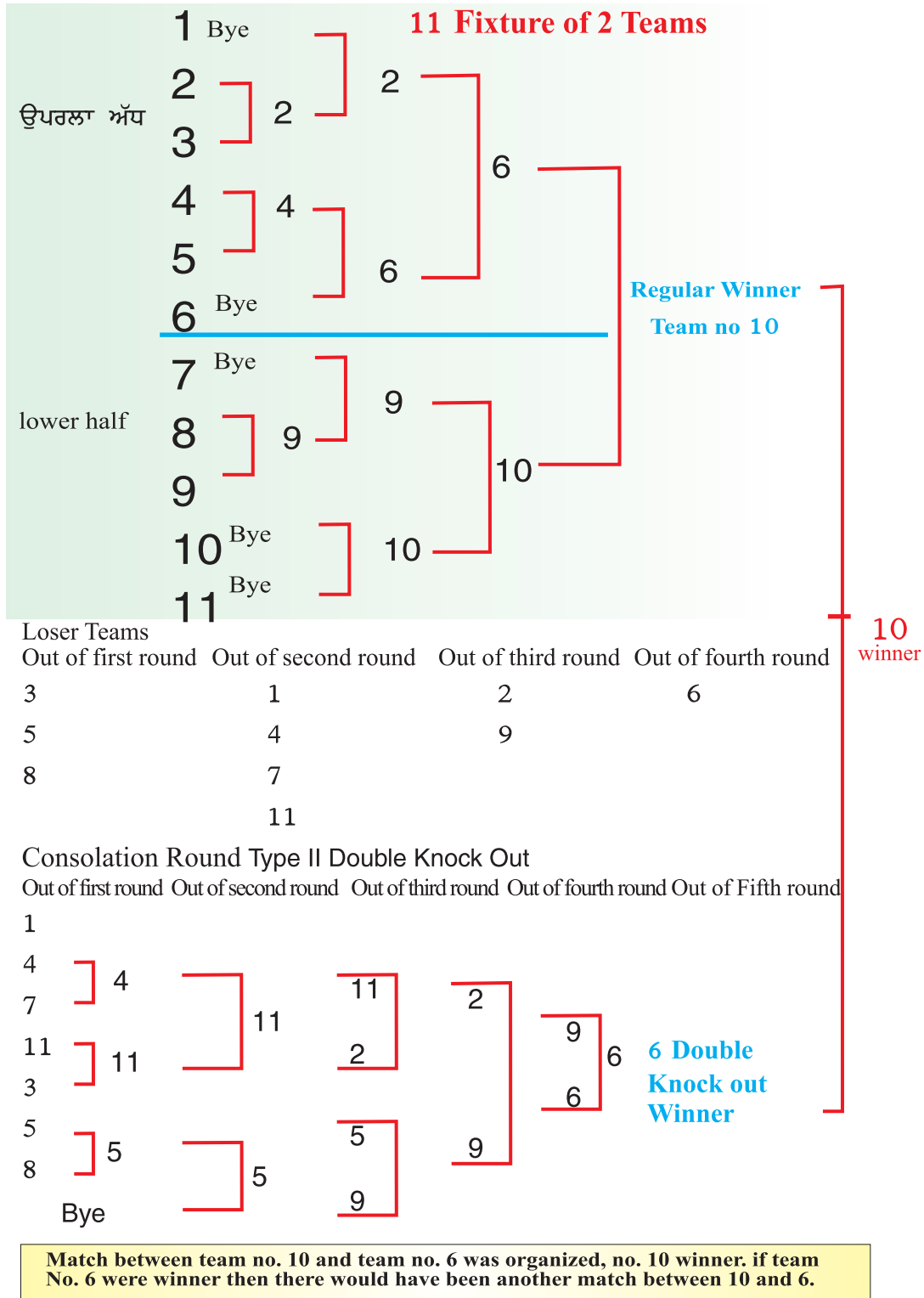

**(iv) Bagnall Wild Tournament**

This tournament is the best method to decide the winners of the first three position holders of the knock-out tournament. In this tournament, the team that wins all the matches gets the first position. For the second place all the teams defeated by the first place winner except the one defeated in the final will play among themselves on a knock-out basis, and their winner will play in the final of regular knock-out tournament. The same method is repeated for the third place.

The fixture of 12 Teams

**The fixture of 12 Teams**

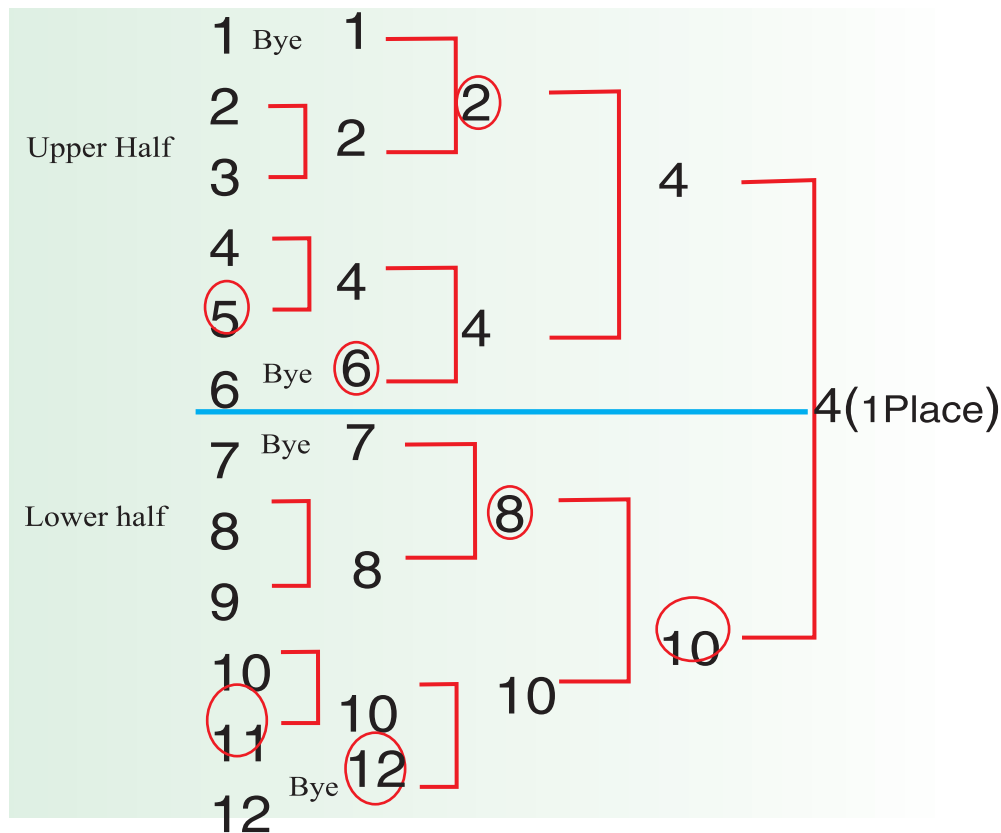

For Second Position (Now teams that have lost to 4)

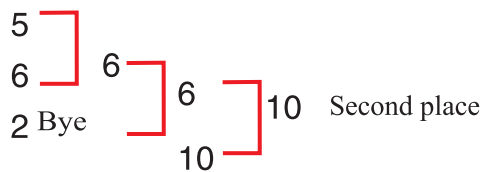

All the matches had been won by team number 4. So that is in the first place, Number 5, 6 and 2 teams have been defeated by team number 4. They will play against one another. The winner among these teams will play against the loser team number 10 in The final.

In the above example, number 10 team has got 2nd place. team 11, 12 and 8 will play against the team that lost to team no 10 in the lower half, i.e against team no. 6. Out of the this, the team that wins will get the third place.

### **League Tournament or Round Robin Tournament:**

In this type of tournament, every team shall again with every other team. All teams in this tournament are considered equal. There are two types of league tournaments: -

1. Single League Tournament
2. Double League Tournament

#### **(i) Single League Tournament: -**

In Single league tournament, each team plays a match once with every other team. If there are 12 teams participating in a tournament, then the number of matches will be 66 for examples.

N' means the total number of teams.

$$\frac{N(N-1)}{2} = \frac{12(12-1)}{2} = \frac{12 \times 11}{2} = \frac{132}{2} = 66 \text{ (Match)}$$

#### **(ii) Double League Tournament:**

In this type of tournament, each team has to play twice with the other teams. If 12 teams participate in this league:

$$\text{Total Teams} = 12$$

$$N(N-1) = 12 = (12-1) = 12 \times 11 = 132 \text{ matches}$$

### **Procedure for drawing the fixture of a single league match**

Single-league tournament has three ways to draw the fixture of matches: -

1. Stair Case Method.
2. Cyclic Method.
3. Tabular Method.

**.1. Staircase Method:**

In this method, the fixtures are drawn in a staircase form. In this case, no bye is given to any team and there is no problem of even and an odd number of teams.

For example fixture of 9 teams is as following:

$$\text{Total matches} = \frac{N(N-1)}{2} = \frac{9(9-1)}{2} = \frac{9 \times 8}{2} = \frac{72}{2} = 36 \text{ matches}$$

At every step or stain the team on left is decided.

1-2								
1-3	2-3							
1-4	2-4	3-4						
1-5	2-5	3-5	4-5					
1-6	2-6	3-6	4-6	5-6				
1-7	2-7	3-7	4-7	5-7	6-7			
1-8	2-8	3-8	4-8	5-8	6-8	7-8		
1-9	2-9	3-9	4-9	5-9	6-9	7-9	8-9	

**2. Cycling Method: -**

In this method, one team is kept as a fixed team. Other teams will be rotated like the hands of a clock. If the number of teams is even and odd then the bye is fixed and all teams are rotated clockwise.

$$\text{Total matches} = \frac{N(N-1)}{2} = \frac{8(8-1)}{2} = \frac{8 \times 7}{2} = \frac{56}{2} = 28 \text{ matches}$$

Rounds of matches=7

1 Round	2 Rounds	3 Rounds	4 Rounds	5 Rounds	6 Rounds	7 Rounds
8 - ①	7 - ①	6 - ①	5 - ①	4 - ①	3 - ①	2 - ①
7 - 2	6 - 8	5 - 7	4 - 6	3 - 5	2 - 4	8 - 3
6 - 3	5 - 2	4 - 8	3 - 7	2 - 6	8 - 5	7 - 4
5 - 4	4 - 3	3 - 2	2 - 8	8 - 7	7 - 6	6 - 5

If the number of teams is ODD number e.g.7, then number of matches will be:

$$= \frac{N(N-1)}{2} = \frac{7(7-1)}{2} = \frac{7 \times 6}{2} = \frac{42}{2} = 21 \text{ matches}$$

Rounds of matches=7

1 Round	2 Rounds	3 Rounds	4 Rounds	5 Rounds	6 Rounds	7 Rounds
7 - Bye	6 - Bye	5 - Bye	4 - Bye	3 - Bye	2 - Bye	1 - Bye
6 - 1	5 - 7	4 - 6	3 - 5	2 - 4	1 - 3	7 - 2
5 - 2	4 - 1	3 - 7	2 - 6	1 - 5	7 - 4	6 - 3
4 - 3	3 - 2	2 - 1	1 - 7	7 - 6	6 - 5	5 - 4

### 3. Tabular Method:

In this method the fixtures is drawn by of a table, i.e. by drawing vertical and horizontal lines (Columns and rows).

If total no. of teams is even, then total no. of boxes = N+1

If the total no. of teams is odd, then total no. of boxes = N+2

After making the required no of boxes the upper corner of the recetangle should be matched with its opposite lower corner.

(90)



For example if a fixture of 6 teams is to be drawn,  
then total no of teams  $6+1 = 7$  boxes.

Total round = 5

if a fixture of 7 teams (odd) is to be drawn, then total no. of teams  
 $7 + 2 = 9$  boxes

The figure of number that comes in the lowest box will be two less  
than the one coming in the upper most box.

The fixture of 6 teams

	A	B	C	D	E	F
A		1	2	3	4	5
B			3	4	5	2
C				5	1	4
D					2	1
E						3
F						

1st Round → A v/s B, C v/s E, D v/s F,

2rd Round → A v/s C, B v/s F, D v/s E,

3rd Round → A v/s D, B v/s C, E v/s F,

4th Round → A v/s E, B v/s D, C v/s F,

5th Round → A v/s F, B v/s E, C v/s D,

The fixture of 7 teams

	A	B	C	D	E	F	G	Bye
A		1	2	3	4	5	6	7
B			3	4	5	6	7	2
C				5	6	7	1	4
D					7	1	2	6
E						2	3	1
F							4	3
G								5
Bye								

1st Round → A v/s B, C v/s G, D v/s F, E v/s Bye

2rd Round → A v/s C, B v/s Bye, D v/s G, E v/s F

3rd Round → A v/s D, B v/s C, E v/s G, F v/s Bye

4th Round → A v/s E, B v/s D, C v/s Bye, F v/s G

5th Round → A v/s F, B v/s E, C v/s D, G v/s Bye

6th Round → A v/s G, B v/s F, C v/s E, D v/s Bye

7th Round → A v/s Bye, B v/s G, C v/s F, D v/s E

### **Main Benefits of the League Tournament**

1. It decides good teams as winners. There is no chance of weak teams to come up as a winner.
2. Greater numbers of matches allow the teams to have a good practice as well as a chance to prove their ability.
3. Due to greater number of matches, the popularity of the game increases.

### **Disadvantages: -**

1. It takes a lot of time to finish the tournament .It also costs more money.
2. Those teams which constantly lose matches become frustrated and their enthusiasm does not last longer for the upcoming event.

### **Method of league Tournament Scoring League Tournament:**

In a league tournament, the winner team is awarded 2 points, teams that remain equal are awarded 1 point each, and the loser team is given a zero. Finally all the points are added and the team that gets the highest no. of points is placed at the first position.

### **4. Mixed Tournament: -**

Matches are conducted at the time when the number of teams playing in the tournament is greater, so the teams are divided into pools. These teams play on the knock out or league basis in their pools. The winner of the pool is decided among these teams. After that the group or pool winners play among themselves again on either knock out or league basis, according to their time and place and decide the winner. In this way, in the case of a big tournament, the state or country is divided into zones. The teams of each zone compete among themselves to decide the champion. This type of tournament is highly recommended for conducting the competition inter district, inter university and state levels. This saves both time and money.

1. Knock -Out-cum- Knockout Tournament.
2. Knock -Out-cum- League Tournament.
3. Leagues-cum- League Tournament.
4. League-cum-Knock out Tournament.

**Methods of Fixture:**

Knock Out- Cum- Knock Out Tournament: -

Example :—

Pool-A

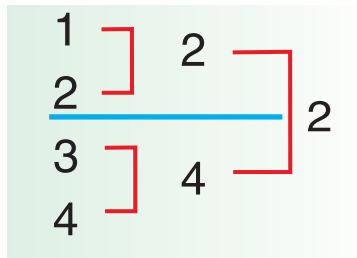

Pool-B

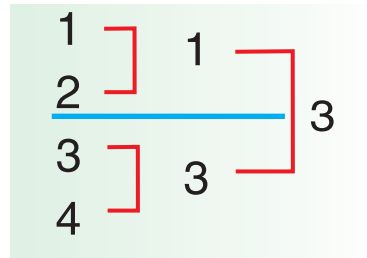

Pool-C

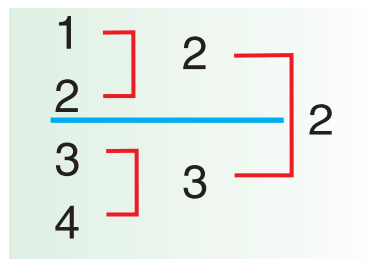

Pool-D

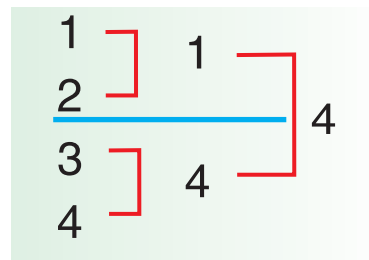

A -2 Winner

B- 3 Winner

C- 2 Winner

D- 4 Winner

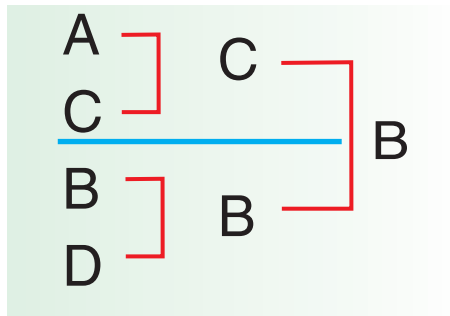

**Knock- Out- Cum- League Out Tournament**

Pool-A

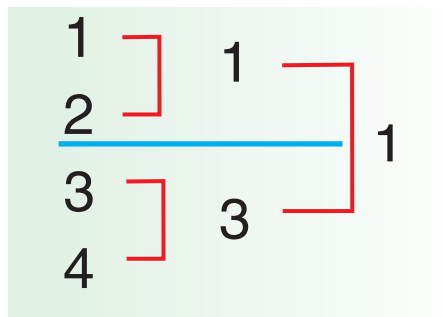

Pool-B

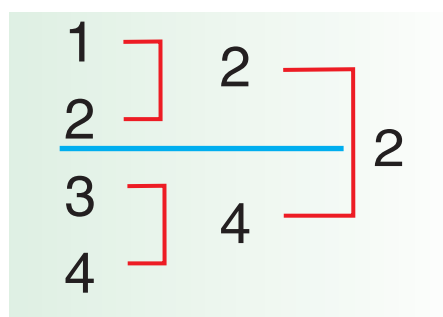

Pool-C

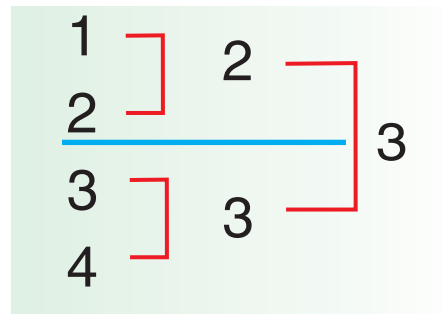

Pool-D

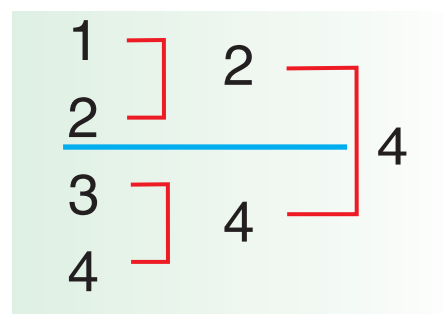

A -1 winner, B-2 winner, C- 3 winner, D- 4 winner.

1 - 2		
1 - 3	2- 3	
1 - 4	2 - 4	3- 4

### League -cum-League Tournament

In league-cum league (tournament), the teams will first play in their respective pools, and on the basis of points or score, a league of four first position winner teams will be organized (held).

### League-cum Knock out Tournament

In this type or method, the teams will first play in their respective pools and a knock out tournament will be conducted among those getting positions in the same (In the pools).

#### 1. Challenge Tournament

This tournament is organized in single or comprising double players each on both sides. In this competition a player challenges the stronger player and the tournament continues. This tournament is usually conducted for the games like badminton, boxing, tennis, table tennis etc. There are two main rules of this tournament:-

1. The Ladder Tournament
2. The Pyramid Tournament

#### 1. Ladder Type:

Gradation of all the players is done on the basis of their previous or earlier performance. On the basis of this gradation, placement in ladder form is done. If no record or knowledge of earlier performance of the players is available, then ladder form is prepared through lottery method.

#### Rules :

1. Any player can challenge another player above him.
2. If a player makes a challenge to another player, the other will have to play a match against him or her in due course of time. Otherwise the player who challenges will be declared the

winner and the grades of two players will be interchanged. For example, gradation of players, on the basis of their performance, will be made in accordance with the rules.

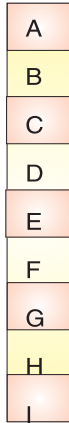

- i. If E challenges D, he or she will be given certain time.
- ii. If D challenges C and D wins, then the challenge made by E automatically finishes.
- iii. If E, after making a challenge to D, wins then E will come at the place of D. But if E loses, then he or she remains at his or her own place and also, he or she cannot make a challenge to D in the tournament again.

## 2. Pyramid Type:

It is the refined form of ladder. In this method many players remain on a single line. If a player wants to move up to upper line then they have to improve their rank order and will have to defeat all the players on their line first. Then they have to make a challenge to a player on an upper line. Thus, the process for improvement of rank will continue, until the player reaches the uppermost line. Hence, this tournament is also known as Funnel Tournament.

Players A, B, C, D, E, F, G, H, I, J

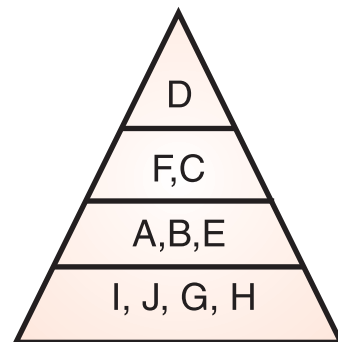

## Sports Management

Availability of qualified officials is very important to conduct quality sports tournaments. Keeping in consideration the sports management, different committees must be formed.

For example:

1. Tournament Executive Committee.
2. Refreshment Committee.
3. Tournament President.
4. Secretary.
5. Finance Secretary.
6. Convener.
7. A Jury of Appeal.

These official must have a through knowledge regarding the sports rules, level of competition and objectives of sports Programme. The officials conducting or organizing a tournament, must be unbiased and transparent in their decision.



**Questions**

1. What is the dictionary meaning of a Tournament ?
2. What precautions should be taken while organising a Tournament ?
3. What is Intramural Tournament ?
4. Write notes on the following :
  - a. Sports Management
  - b. Challenge Tournaments
  - c. Ladder and Cyclic Methods
5. What is meant by a Bye ? How is it drawn or decided in a Single Knock out System ?
6. If 19 teams take part in a Single Knock out System Tournament, then how many byes will be given and how many matches will be played ?
7. How many parts is Mixed Tournament divided into ?
8. Write about the merits and demerits of Knock out and League Tournaments.

**PRACTICAL PART**

## LESSON - 1

# YOGA

The word “yoga” has been derived from the Sanskrit word ‘yuj’, which literally means to connect or tie. Yoga is the union of the soul with God. The importance of yoga is understood by learning about yogic exercises and spiritual relations. The purpose of yoga is to develop the latent powers of a human being by combination of his virtues, strength and powers and thus help him make religious, psychological and spiritual achievements. Yoga is also helpful in improving the health, physical fitness and emotional stabilities a common man.

With the help of “Yogasana”, body is made clean and supple, and body muscles and systems are made capable of performing their functions actively or efficiently. Pranayama cleanses our blood, keeps our body disease free and healthy, and helps us lead a good life.

### TYPES OF YOGA

1. Ashtanga Yoga.
2. Hatha Yoga.
3. Janan Yoga.
4. Manter Yoga.
5. Bhagti Yoga.
6. Kundali Yoga.
7. Karam Yoga.
8. Kiriya Yoga.
9. Swara Yoga.

## ELEMENTS OF ASHTANGA YOGA

1. Yama
2. Niyama
3. Asana
4. Pranayama
5. Pratihara
6. Dharna
7. Dhyana
8. Samadhi

Some Asanas commonly performed by people, are given below :

### 1. TAD ASANA :

Straighten the arms upright by joining the heels and toes (of the feet) together. Keep the fingers of both the hands intact. Keep your eyes fixed towards the front and hands upright. Hold your whole breath in. Put full body weight on the toes by pulling the body upwards. After sometime leave the breath (exhale) and take the body downwards.

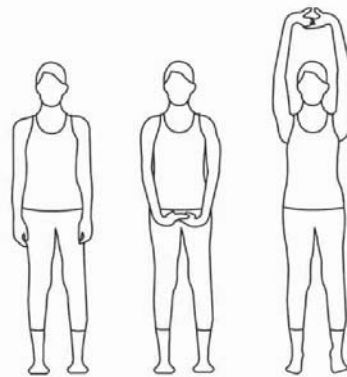

### 2. VRIKSH ASANA :

Stand straight with one foot placed on the innerside of the thigh of the other leg bearing your whole body weight. Hands should be in the Namaskar or praying position, i.e. they (both



hands) should be joined together. Take the shoulders straight upwards one should keep breathing continuously.

### 3. BHUJANG ASANA :

It is a very beneficial asana for back muscles and stomach muscles. Lie flat on your stomach, turn your elbows, and while touching your body place both hands on sides of your chest on the ground. Legs should be straight and with the help of both hands, lift the upper part of your body upto the belly button. The head goes upwards and while taking the throat part or the base upwards, ankle should be kept straight on the ground.



### 4. ARDHCHAKKAR ASANA :

In Sanskrit, “Ardh” means half and “Chakkar” means wheel. Stand straight with both hands on the sides of the thighs. Some distance is to be kept in between the feet. Bending backwards, both hands are to be kept on the waist, and one is to bend backwards like a half wheel. This asana reduces fat from the waist. The chest is spread due to retreat which helps the asthmatic patients. It also helps in curing the backache or the waist pain.

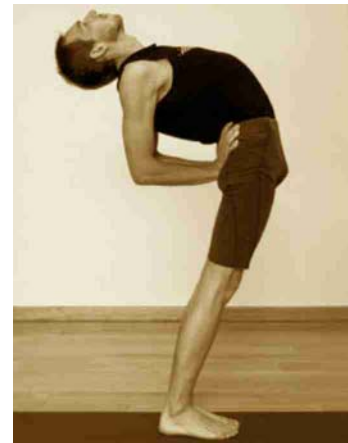

**5. CHAKRA ASANA :**

Lie down on the back. Keep both your palms at the back of your head near the shoulders with fingers pointing inwards. Turn both your legs with Knees. Keep the bases of your feet with the ground and lift your body up in the air in such a manner that it looks like a bridge. Your head should be in a very comfortable or easy state. Keep your body in this position for some time.

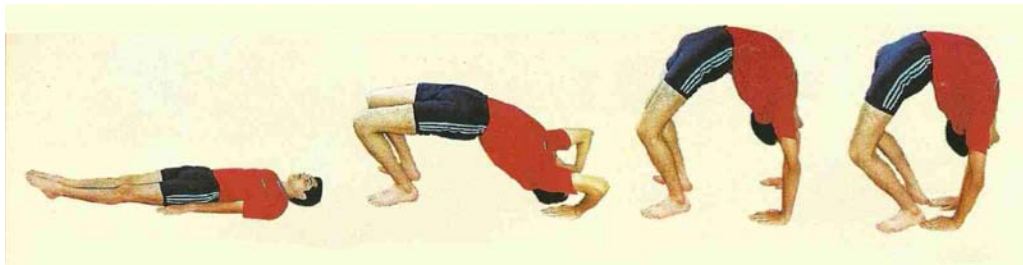

**6. USHTRASANA:**

In Sanskrit, Usht means Camel. In this asana, the body looks like a camel. Sit down in Vajra asana. Kneel on the floor keeping your thighs, knees and feet joined together. While bending backwards hands are to be joined with both foot soles. The chest and the ribs should be spread. It is helpful in enhancing the functioning of the lungs, and also in strengthening the back and the spine (backbone).



**7. SHALBHASANA :**

It is the opposite of Bhujanga Asana, in which the lower part of the body is raised from the ground upwards. Lie down on your stomach; place both hands straight and underneath the thighs support your legs and lift them up in the air. Your chin should rest on the ground and eyes should be straight.



**8. HALASANA :**

In this, lie on the back and with hands preventing (protecting) the body from falling down, lift the body from the ground upwards. The body is in the turned position and the toes at the back side of the head touch the ground. Both knees should remain unturned.

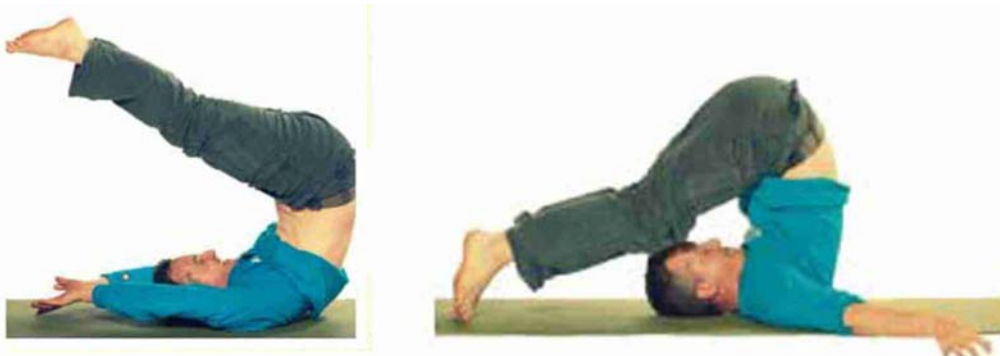

**9. PASHCHIMOTANASANA :**

While exhaling sit on the ground with legs stretched out in front of you. Bend your waist upon the legs and stretching your hands forward hold the soles of the feet. The knees should remain

straight. Try to touch the Knees with forehead, and ground with elbows. This position should be maintained for some time while breathing normally.



#### 10. TRIKONA ASANA :

Open your feet at a length double the width of shoulders. Bend your body on one side and hold (with your hand) the great toe of the bending (bent) side. The other hand should be straight with fingers upwards palms towards the front. The direction of the head should be straight towards the upper arm. Face and eyes should be towards the sky. Knees and elbows should not be turned.

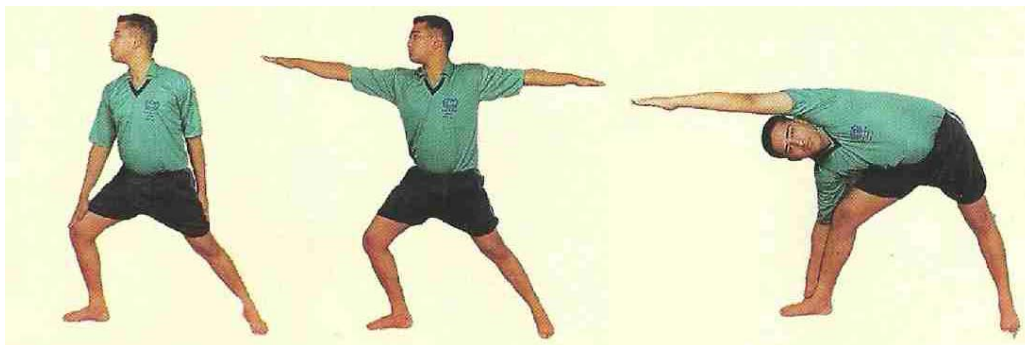



**EXERCISE**

- 1) From which Sanskrit word has the word 'Yoga' been derived ?
- 2) Name the types of 'Pranayama'.
- 3) Name any six types of Yoga.
- 4) Name the elements of "Hath Yoga".
- 5) Give the method of ' Taad Asana'.
- 6) Describe the method of "Pashchimotan Asana".

—0—

—(107)—

**LESSON - 2****VOLLEYBALL****Things to Remember :**

<b>S.NO</b>	<b>DESCRIPTION</b>	<b>MEASUREMENTS</b>
1.	Length and breadth of Volleyball ground	18 meters x 9 meters
2.	Height of Net for Men	2.43 meters
3.	Height of Net for Women	2.24 meters
4.	Length and breadth of Net	9.50 mts. x 1 mts.
5.	Size of boxes of the Net	10 x 10 Centimeters.
6.	Length of Antennae	1.80 meters
7.	Thickness of Antennae	10 mm.
8.	Circumference of the ball	65 Centimeters to 67 Centimeters
9.	Weight of the ball	260 grams to 280 grams
10.	No. of players in the team	12 (6 players +6 extra)
11.	Width of the lines	5 Centimeters
12.	Dividing line of the Volleyball Court	Centre line
13.	Officials of Volleyball match	2-Referees, 1-scorer, 2-lineman

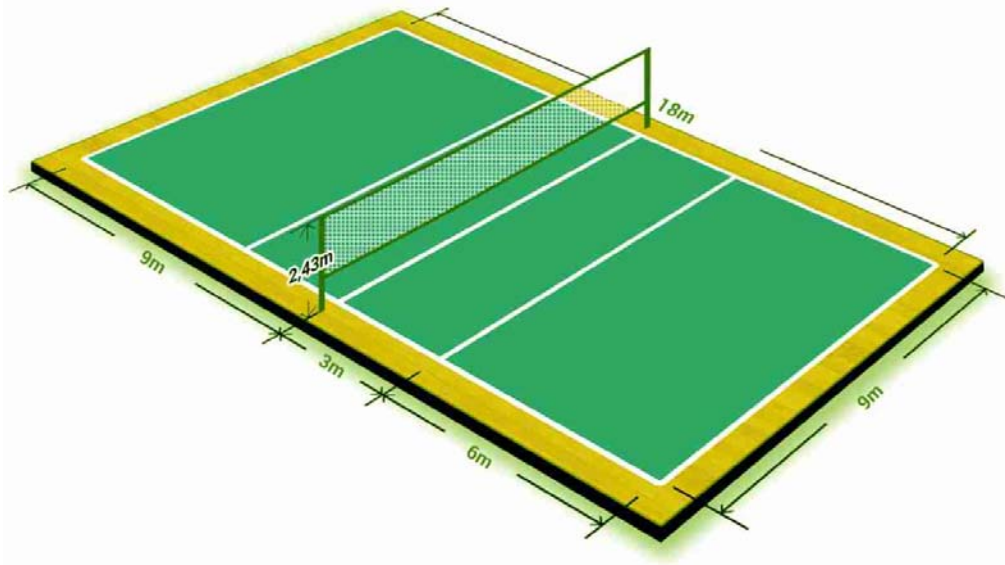

### **VOLLEYBALL GROUND :**

The Volleyball ground is 18 meters long and 9 meters wide. There should no obstruction up to 7 meter of height in the court. Ground lines are 5 centimeters wide.

### **POLES AND NET :**

The Net is placed on the central line of the Volley Ball ground. The length of the Net is 9.50 meters and breadth is 1 meter. Boxes of the Net will be  $10 \times 10$  centimeters. There will be antenna on both sides of the Net, 0.80 mts in height. During the game the ball should pass through these antennae. For Men the height of the Net is 2.43 mtrs. and for Women it is 2.24 mtrs. Both the poles should be 50 cms. away from the ground .

### **ATTACK AREA :**

The area of attack is made by a 5 cm wide line, 3 meters away from the Centre line, in each part of the court.

### **SERVICE AREA :**

Service can be done from anywhere on the end line of the court which is 9 meters wide. The game starts after service is done.

### **BALL :**

The ball should be soft and spherical. There is a rubber bladder in it. The circumference of the ball should be 65 cm to 67 centimeters. It should be 260 grams to 280 grams in weight.



65 to 67 Centimetre

### **PLAYERS :**

There are 12 players in a team. Only six players of each team play and the remaining six players are extras. They can be changed according to the needs. In the game three players always play ahead (attack area) and three players are present behind.

### **LIBRO PLAYER :**

This player's uniform will be different from the rest of the players. He is a defensive player. This player can enter with his own consent at any time. This player does not need to be sanctioned by the sports official. This player cannot serve, attack, block or lift. This player cannot even stop the service.

### **PLAYERS' POSITION :**

Before the service starts, players of both teams stand in their respective areas, in which three players stand in the attack area and three players stand at the back. These players are not required to be in a line. Any player can take the ball even after the service but players of the back zone cannot smash by going to the attack zone. This condition

of the players will remain until the service changes. The players can change or rotate only clockwise. If the players do not change according to the rotation or make a mistake, the opponent team will be given a point and the referee will correct their rotation.

### **GAME OFFICIALS :**

The following officials are appointed to play Volleyball matches according to the rules. Referee - 2, scorer - 1, lineman - 2 to 4.

### **RULES OF THE GAME:**

**To organize any Volleyball match, the following rules are followed :**

- 1) Before starting the game, the captains of both teams are invited for the toss. The captain of the winning team chooses the service or the side.
- 2) Referee informs both the teams that there will be a match of three or five sets. Each set is of twenty five points. The team that first earns twenty five points wins that set, but in case both the teams have 24- 24 points, any team has to take two points lead to win. In a game of five sets, in case both the teams have won 2-2 sets, the fifth set to be played will be of 15 points. For this final set, there will be another toss to determine the side. There will be a toss to take the decision for the side of the 5<sup>th</sup> set.
- 3) Any team's mistake is given to the opposing team an opportunity and a chance to serve.
- 4) When the player serves, the opposing team players are required to stand on their positions but they can change their positions after service.
- 5) In each set 6 players can be changed. Players can be replaced after informing the referee. The player is only allowed to play on the same position of the player to be replaced.

- 6) Player can play the ball with any part of the body.
- 7) A team can take two time-outs in a set. One time-out is of 30 seconds duration. During the time-out, the player can only talk to his coach.
- 8) During service if the player touches the line, throws the ball out of the net antenna or if the ball crosses below the net, it is considered a foul. After the Referee whistles, the service has to be done within 5 seconds. If the player does not serve within this particular time period then the service will be given to the opponent team.
- 9) After each set, a rest of 2 minutes is given. In the meantime, teams change their sides, but after 13 points in the deciding set, both teams will change sides but the players position will not be changed.
- 10) Only 3 time touches are allowed while throwing the ball to the opposite side. No player can touch the ball for 2 consecutive times, except while blocking a smash.
- 11) No player can touch the Net during a playoff game. If the Net is touched by any of the players, the opponent team is given a point.

#### **FOULS IN VOLLEYBALL GAME :**

**The fouls of volleyball game are given as below :**

- 1) If a player touches the ball continuously for two consecutive times then a foul is considered.
- 2) If a player touches the net during the game it is considered a foul.
- 3) If the players touch the ball more than 3 times while throwing to the opponent team, it is considered a foul.
- 4) If the rotation of the team is not done, a foul is considered.
- 5) If the player touches the line while servicing, a foul is considered.

- 6) If any player at the back enters the attack zone to smash, it is considered a foul.
- 7) If a sound arises while a player receives the ball at his finger, it is a foul.
- 8) If a player catches the ball during the game, it is considered a foul.
- 9) If a player throws the ball out of the opponent team. It is considered a foul.
- 10) If the player rolls the ball on his arm, it is considered a foul.

**EXERCISE**

- 1) Give the length and breadth of the Volleyball ground ?
- 2) Give the weight of the Ball ?
- 3) How many officials are there in total in a Volleyball match ?
- 4) Give any four fouls in a Volleyball game ?
- 5) How many players are there in total in a Volleyball team ?
- 6) How many players can be changed in a volleyball game ?

—0—

—(113)—

### LESSON - 3

## ATHLETICS

Athletics is a set of sports events, which includes running, throwing and jumping. The participant of these events is called an Athlete. The track and field events were discovered in the 19<sup>th</sup> century. These events were organised in academic institutions and sports clubs, and to enhance the physical efficiency of soldiers. But with the passage of time, these events took the form of a competition. Today, these competitions are organised in Schools, Colleges and Universities at District, State, National and International level.

#### A. TRACK

Running Events are practiced in an oval shaped ground which is referred to as a Track and these Events are called Track Events.

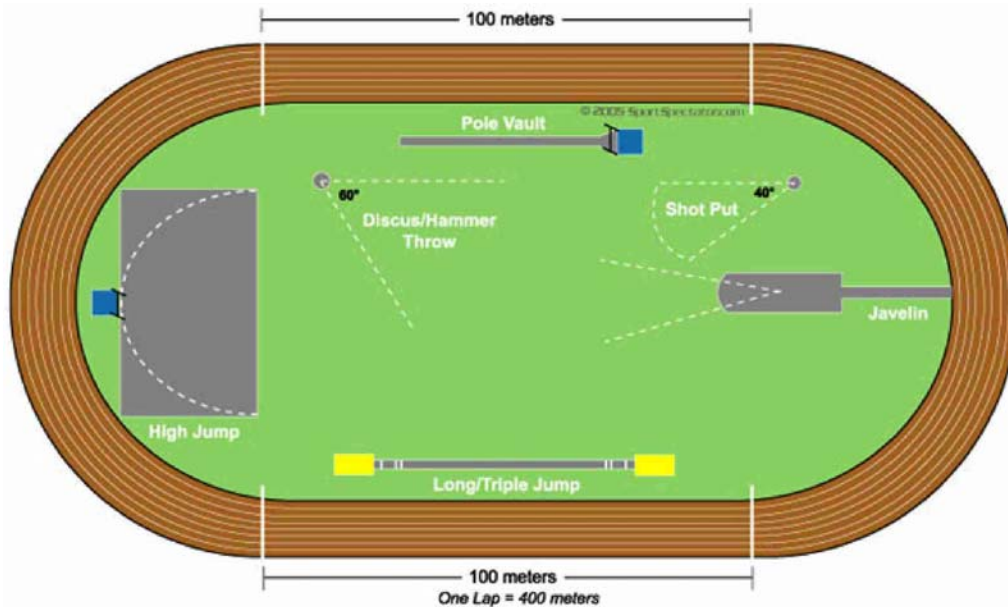



The structure of a track has been certified by the International Athletic Amateur Federation which has approved a 400 m track as the standard one, which comprises (paths) 2 straight and 2 curves (curved path) making it look like an oval shaped. A track has 8-10 lanes. The width of each lane is 1.22 m. The thickness of all the lines in a track is 5 cm. These lanes are including in terms of distance, length and thickness but the finish line of the track is not included in it.

### 1. TRACK MARKING FORMULA :

To mark the 400 m track, the following things should be taken care of :

1. Direction of the track- from North to South
2. Straight in the track : two straight
3. Curve in the track : two Curve
4. Approximate space around the Track- 5 mtrs.



a) If the length of the track is straight, the formula to know the curve is :-

1. Length of the straight :-  
Two straight = straight :80 + 80= 160 mtrs.
2. Total curves of the Track :- 400 m – 160 m = 240 mtrs.
3. Formula to know the curve:-  $2 \times \frac{22}{7} \times r$
4. Circumference of the circle :-  $2 \times \frac{22}{7} \times r$

$$r = \frac{240}{2} = 2 \times \frac{22}{7} \times r$$

$$R = \frac{240}{2} \times \frac{7}{22} = 38.18 \text{ mtrs.}$$

Track is marked after all these measurements are taken

The Track has 8-10 lanes.

### STAGGER :

All athletes are given stagger in each lane to determine the distance in the track in equal distance.

#### b) Formula to calculate stagger :-

$$[1.22 \text{ m (Lane no. - 1) - 10 cm}] 2\pi$$

#### c) Formula to know the distance between the lanes :-

W = Width of the Lane (1.22)

N = No. Of lane

LANE NO.	STAGGER
1.	
2.	7.04 meter
3.	14.70 meter
4.	22.37 meter
5.	30.03 meter
6.	37.70 meter
7.	45.36 meter
8.	53.03 meter

## 2. TRACK EVENTS

### 1. Short distance Race :

100 m, 200 m, 400 m, 110 m hurdles (for men) , 100 m hurdles (for women), 400 m hurdles , Relay races  $4 \times 100$  mtrs. and  $4 \times 400$  mtrs. races.

### 2. Medium distance Race :-

800 m and 1500 m race.

3. **Long distance Race :-**

3000 m, 5000 m , 10000 m, 3 km walk, 5 km walk, 20 km walk, Cross Country and Marathon Race.

3. **TYPES OF START**

- i) Standing start
- ii) **Crouch start**
  - i. Bunch start
  - ii. Medium start
  - iii. Elongated start

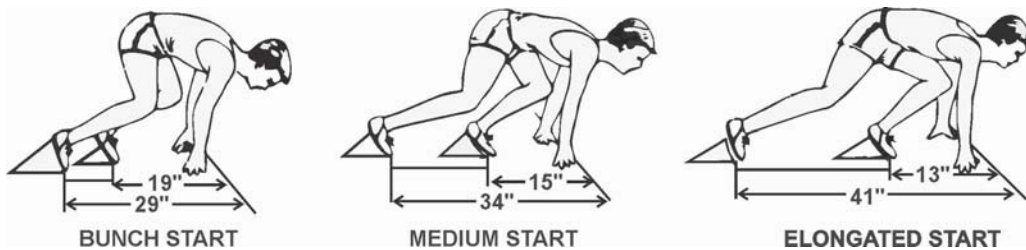

4. **COMMAND DURING START**

- i) On your mark
- ii) Set
- iii) Go

5. **TYPES OF TIMING AT THE FINISHING STAGE OF THE RACE :**

- i) Long finish
- ii) Shoulder shrug finish
- iii) Run through finish

6. **HURDLES :**

The distance of Hurdle races for women and men is 100 m and 110 m respectively and the 400 m hurdle race is the same for both. In each lane 10 hurdles are kept. The length of the hurdle

for 110 m is 1.067 m (for men) and for 100 m, it is 84 cm (for women). The height of hurdles for men and women in 400 m race is 91.4 and 76.2 cm respectively. The weight of a hurdle is 10 kg. The width of the bar is 70 mm.

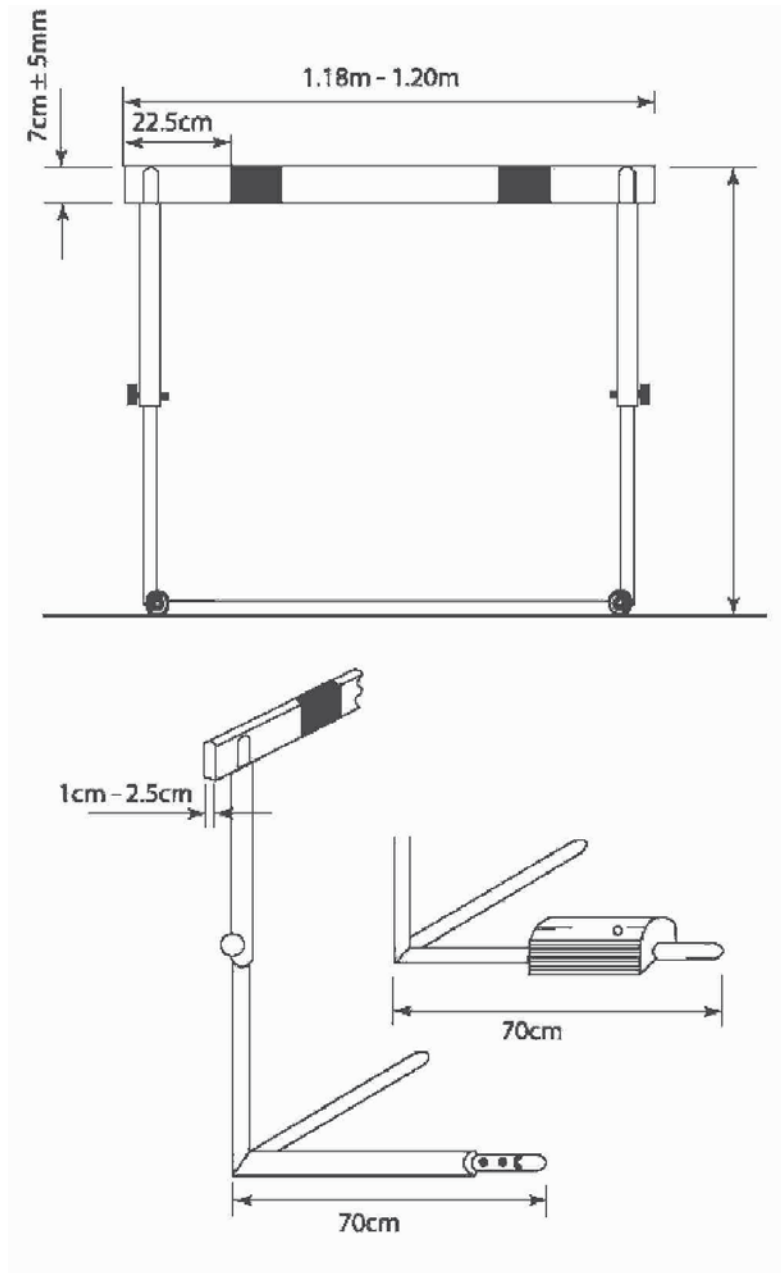



### **RULES :**

1. Athlete is declared disqualified if he deliberately throws the hurdle.
2. The athlete is declared a winner if he covers the distance of Race in minimum time.
3. If the hurdle falls during the fair play by the Athlete, he is not considered guilty.

### **7. RELAY RACES**

Relay Races mean a particular distance covered by 4 athletes consecutively and where in a Baton is used by the athletes one after the other while running.

1. Length of a Baton :- 28-30 cm
2. Diameter of a Baton :- 12-13 cm
3. Weight of a Baton :- less than 50 grams

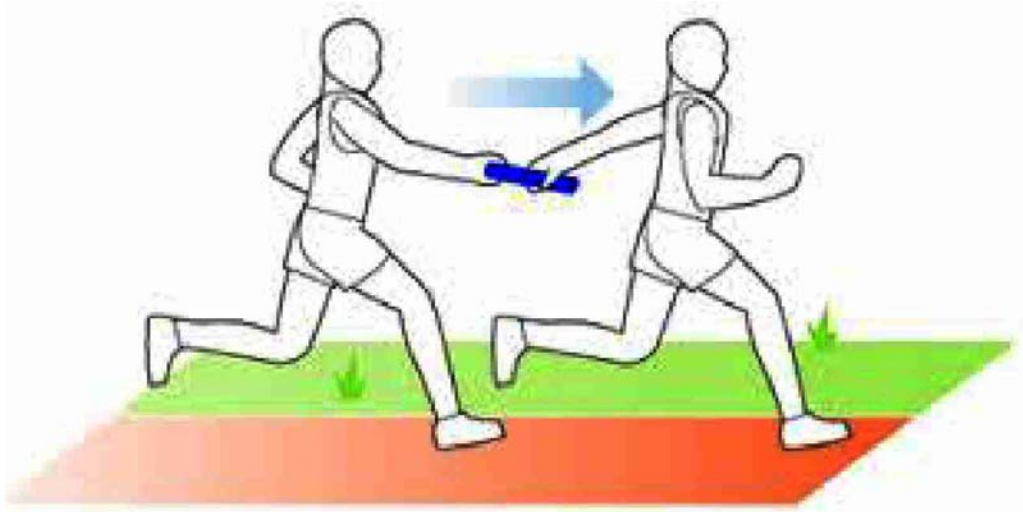

**B. FIELD EVENTS :-**

Field events are of 2 types : Throwing events and Jumping events

**i) Throwing Events :**

Throwing events are of four types viz. Shot-put, Discus throw, Javelin Throw and Hammer throw.



**MEASUREMENTS OF THE THROWING SECTOR FOR SHOT PUT :**

<b>S.NO.</b>	<b>DESCRIPTION</b>	<b>MEASUREMENTS</b>
1.	Diameter of the sector for Shot put	2.135 m
2.	Restraining lines out of the sector	0.75 cm
3.	Angle of sector	34.92°
4.	Length of the sector	25 m
5.	Length of the Stop Board	1.21m to 1.23 m
6.	Width of the Stop Board	11.2 cm to 30 cm
7.	Height of the Stop Board	98 m.m to 102 m.m
8.	Colour of the Stop Board	White
9.	Width of the lanes	5 cm
10.	Weight and circumference of the shot-put (for men)	7.260 kg and 110-130 m.m
11.	Weight and circumference of the shot-put (for women)	4kg and 95-110 m.m
12.	Technique of shot-put	Perry O-Brain style and Discopot style

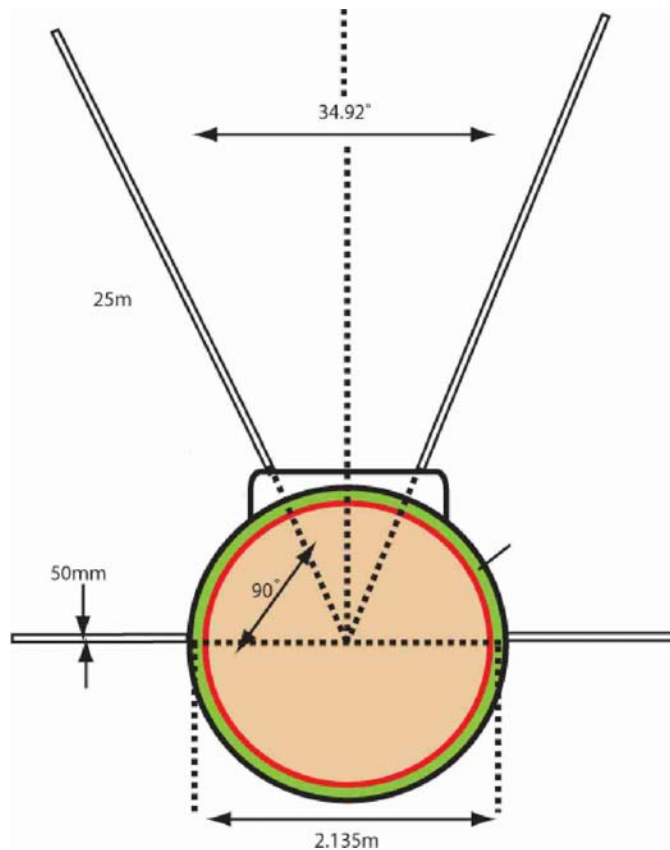

### RULES :-

1. The Athlete is given 3 chances to throw the Shot Put.
2. The one who throws at a maximum distance is declared the winner.
3. While throwing the Shot Put, Athlete should not touch the line otherwise he is disqualified.
4. The Athlete is to enter from the backside of the sector for throwing.
5. After throwing the Shot Put, the Athlete goes back from the restraining line.
6. The Athlete enters only after the call from the officials.



**DISCUS THROW**

S.NO.	DESCRIPTION	MEASUREMENTS
1.	Diameter of the Discus Throw sector	2.50 m
2.	Restraining lines (lines stretched out from the centre)	0.75 cm
3.	Angle of the sector	34.92°
4.	Width of the lines	5 cm
5.	Thickness of the Rim outside the sector	6 m.m
6.	Weight and circumference of the Discus (for men)	2 kg and 219-221m.m
7.	Weight and circumference of the Discus (for women)	1 kg and 180-182m.m
8.	The thickness of the rim of Discus	10-12 m.m
9.	Circumference of the metal plate of Discus	50-57 m.m

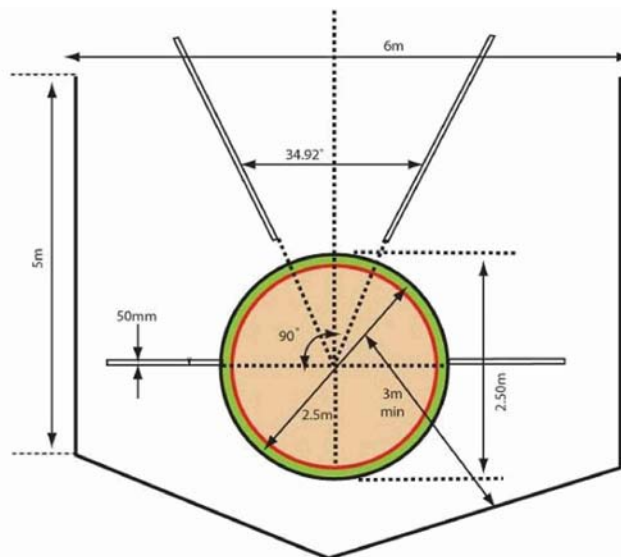

**RULES :**

1. The athlete enters the sector for discus throw from the backside.
2. The athlete is given 3 chances to throw.
3. The one who throws at a maximum distance is declared the winner.
4. If the athlete touches any line during the throw, he is considered disqualified.
5. The athlete is given 1.30 minutes to throw.
6. The athlete must throw the discus in the marked sector only, otherwise he is declared disqualified.
7. After throwing the discus the athlete goes back from the backside of the sector.
8. The athlete enters the sector after the call from the concerned official.

**JAVELIN THROW :-**

<b>S.NO.</b>	<b>DESCRIPTION</b>	<b>MEASUREMENTS</b>
1	Length of the runway for Javelin Throw	30 m to 36.50 m
2	Width of the Runway	4 m
3	Restraining line	0.75 meter
4	Angle of sector	28.95°
5	Width of the lines	5 cm
6	Width of the sector arc	7 cm
7	Length of Javelin (for men)	2.60 to 2.70 m
8	Length of Javelin (for women)	2.20 to 2.30 m
9.	Weight of Javelin (for men)	800 grams
10.	Weight of Javelin (for women)	600 grams

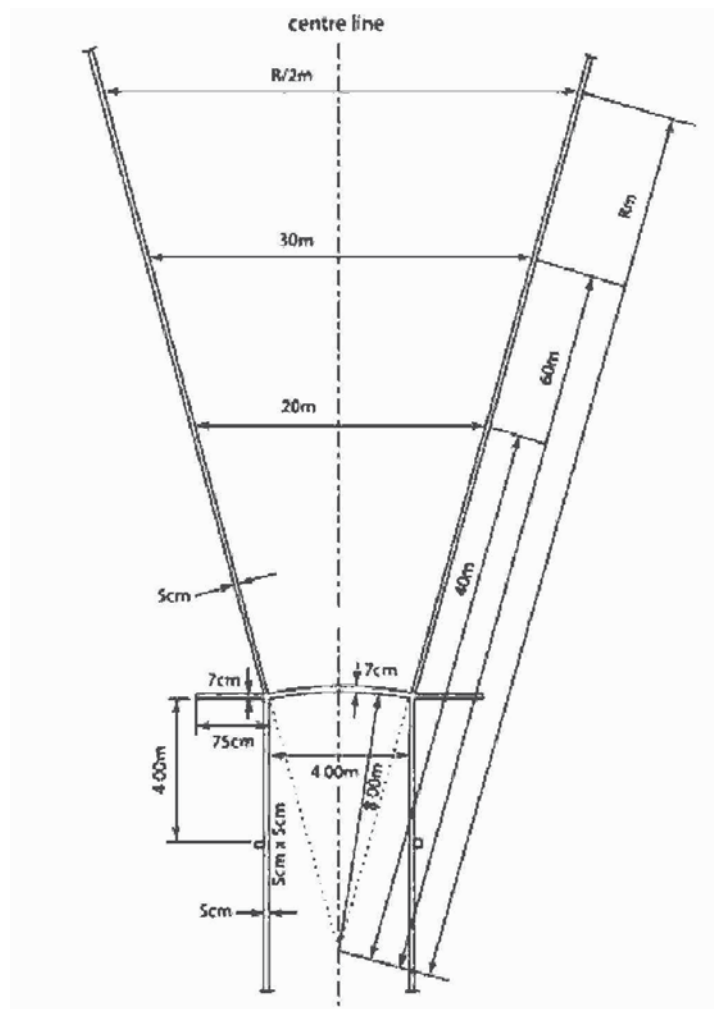

**RULES :-**

1. For throwing the Javelin the athlete enters from backside of the sector.
2. The athlete is given 3 chances to throw the Javelin.
3. The one who throws at a maximum distance is covered the winner.
4. If the athlete touches any line during a throw, he is considered disqualified.

5. The athlete is given a time of 1.30 minutes to complete the throw.
6. The throw by a Athlete must land in the marked sector, otherwise it is considered Foul.
7. The athlete returns from the backside of the sector only, after throwing the Javelin.
8. The athlete enters the sector only after a call from the official.
9. The athlete must not touch the width of the arc (restraining line) of the sector during the play, otherwise it's a foul.
10. The athlete comes out from the restraining line only after throwing the Javelin.

#### **HAMMER THROW :-**

<b>S.NO.</b>	<b>DESCRIPTION</b>	<b>MEASUREMENTS</b>
1.	Diameter of the sector of Hammer	2.135 m
2.	Angle of sector	34.92°
3.	Width of the lines	5 cm
4.	Weight of the Hammer (For men)	7.26 kg and 219-221 m.m
5.	Weight of the Hammer (for women)	4 kg and 180-182 m.m
6.	Length of the cord of Hammer	1.22 m (117.5 cm 121.5 cm
7.	Diameter of Hammer	110 m.m-130 m.m
8.	Thickness of the cord of Hammer	102-120 m.m

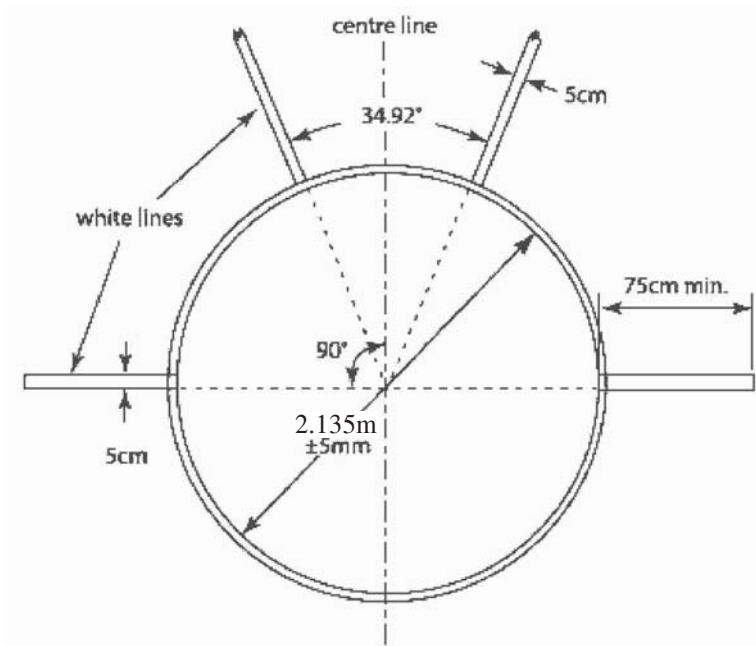

**RULES :**

1. The athlete enters from the backside of the sector for Hammer throw and he must not touch the sector during the throw.
2. The athlete is given three chances to throw.
3. The one who throws at a maximum distance is declared the winner.
4. During a throw, the Hammer is kept inside the sector only.
5. If the athlete touches any line during a throw, he is considered Foul.
6. The athlete is given a time of 1.30 minutes to complete the throw.
7. The throw by the athlete must land in the marked sector, otherwise it is considered Foul.

8. The athlete comes out from the restraining line only after throwing the hammer.
9. The athlete enters the sector after a call from the official.

## JUMPING EVENTS

There are four types of Jumping events viz. Long Jump, High Jump, Triple Jump and Pole Vault.

### A) LONG JUMP

S.NO.	DESCRIPTION	MEASUREMENTS
1	Length of the Runway	40 m
2	Width of the Runway	1.22m
3	Length of the Take Off Board	1.22m
4	Width of the Take Off Board	20 cm
5	Depth of the Take Off Board	10 cm
6	Width of the plastic indicator	10 cm
7	Angle of the plastic indicator in the direction of Runway	30°
8	Length of the landing Area or pit	6-9 m
9	Width of the landing Area or pit	2.75 - 3.00 m
10	Distance between the Take Off Board and the start line of the landing Area or pit.	1m to 3m

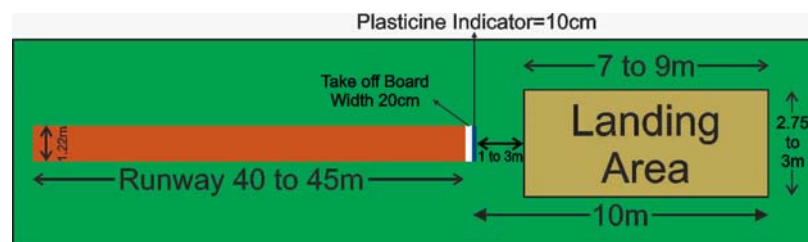

**RULES :**

1. The athlete enters the Runway after a call from the official.
2. The athlete gets 3 chances to jump. If the number of qualifying Athlete is 8 then the Athlete gets 3 chances and if the number is less than 8 then the Athlete gets 6 chances.
3. No athlete can check mark in between runway and land Area or pit.
4. The one who jumps at the maximum distance is declared the winner.
5. The athlete gets a time of 1.30 minutes to jump.
6. The athlete takes the last step from Take Off Board. If the athlete incidentally touches the plastic indicator while taking step from the Take-Off Board, it is considered a foul.
7. The last touch by the athlete in the landing area or pit is considered the distance covered by him.

**TRIPLE JUMP :**

<b>S.NO.</b>	<b>DESCRIPTION</b>	<b>MEASUREMENTS</b>
1	Length of the Runway	40 m
2	Width of the Runway	1.22m
3	Length of the Take Off Board	1.22m
4	Width of the Take Off Board	20 cm
5	Depth of the Take Off Board	10 cm
6	Width of the plastic indicator	10 cm
7	Angle of the plastic indicator in the direction of the Runway	30°
8	Length of the landing Area or pit	6-9m
9	Width of the landing Area or pit	2.75 to 3.00 m
10	Distance between Take Off Board and start line of the landing Area or pit.	11m to 13 m

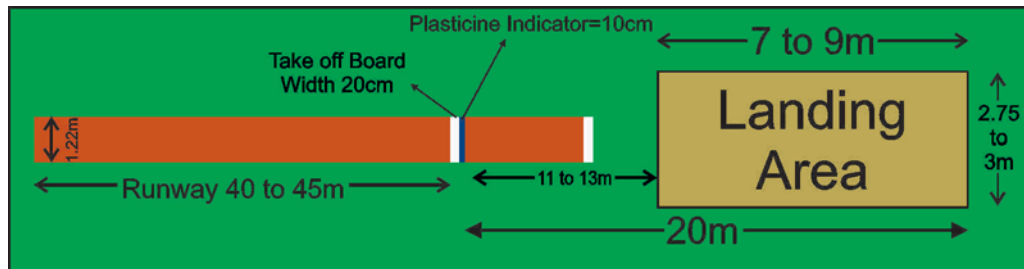

### RULES :

1. The athlete enters the runway after a call from the official.
2. The number of chances in Triple Jump are in unison with those in the long jump.
3. After crossing the run way, the athlete needs to use hope-step-jump through any technique.

### HIGH JUMP :

S.NO.	DESCRIPTION	MEASUREMENTS
1	Length of runway (marked in the form of arc)	20-25 m
2	Length of landing mat	5 m
3	Width of landing mat	r m
4	Thickness of landing mat	60 cm
5	Distance between apparatus	3.66 m to 4.04 m
6	Length of cross bar	3.98 m to 4.02 m
7	Weight of cross bar	2 kg
8	Circumference of the cross bar	25 to 30 m.m



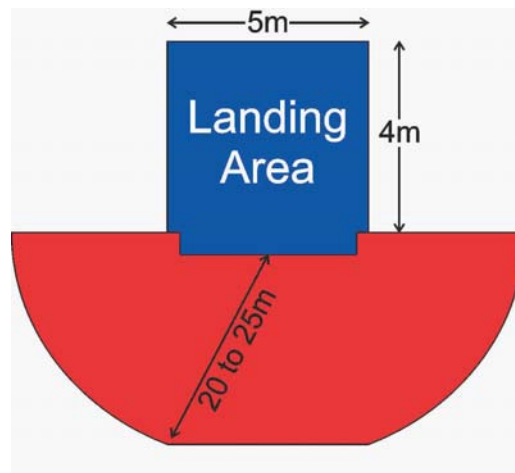

**RULES :-**

1. If the athlete touches the bar or it falls during the jump, that jump is considered Foul.
2. If there is no length of the Runway, the Athlete can put a check mark on the Runway.
3. If the cross bar falls off while crossing, it's a foul.
4. The athlete can decide the height of jump voluntarily.
5. After the athlete crosses the height, he is given more height.

**POLE VAULT :**

S.NO.	DESCRIPTION	MEASUREMENTS
1	Length of Runway	40 to 45 m
2	Width of Runway	1.22m
3	Length of the landing mat	5 m
4	Width of the landing mat	5m
5	Thickness of the landing mat	61 cm to 91 cm
6	Distance between apparatus	4.30 to 4.37 m
7	Length of cross bar	4.48 to 4.52 m
8	Weight of cross bar	2.25 kg
9	Circumference of cross bar	25 to 30 m.m

10	Length of Vaulting Box	1.084 m
11	Width of Vaulting Box from back	60 cm
12	Width of the Vaulting Box from front	40.8 cm
13	Area of steel line in Vaulting Box	80 cm
14	Depth of Vaulting Box	22.4 m in triangular form and 20 cm from front

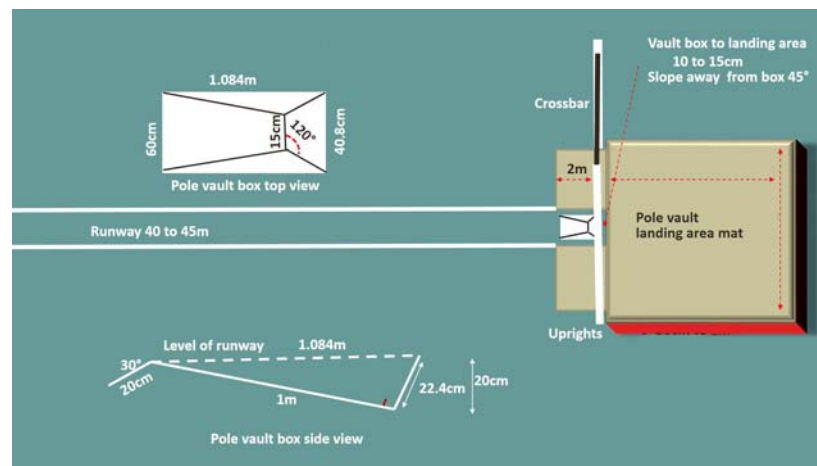

### RULES :-

1. The athlete can use any powder like magnesium carbonate to hold the pole.
2. The athlete has his individual pole.
3. If the crossbar falls while crossing, it's a foul.
4. The athlete can decide the height of jump voluntarily and start jumping.
5. Once the athlete jumps the decided height, it is increased by 5 cm. He is given three chances to cross each height.

**EXERCISE**

- 1) How many parts is an Athletic event divided into ?
- 2) What are track events ?
- 3) Give the weight of Javelin for men ?
- 4) Give the Diameter of Discuss for men ?
- 5) Give any five rules or principles of Hammer Throw ?
- 6) Which are Throwing Events ?

—0—

—(133)—

**LESSON - 4****TABLE TENNIS****Things to Remember**

<b>S.NO.</b>	<b>DESCRIPTION</b>	<b>MEASUREMENTS</b>
1.	Shape of Table	Rectangle
2.	Length of Table	274 centimeters
3.	Width of Table	152.5 centimeters
4.	Height of Table from the floor	76 centimeters
5.	Length of the net	183 centimeters
6.	Height of the net from the playing surface	15.25 centimeters
7.	Diameter of the ball	40 m.m.
8.	Weight of the ball	2.5 grams to 2.7 grams
9.	Ball's material	Celluloid or white plastic
10.	Colour of the table	Dark green
11.	Officials	1-Referee, 1-Umpire, 4-Corner Judges

**HISTORY :**

Table Tennis is a popular indoor Game. The game was earlier known as 'Ping - Pong'. This game was started around 1880 in England. That's why 'Ping Pong' association was established in England, but after some time it was renamed as Table Tennis Association. 'International Table Tennis Federation' was established in 1926. The

First International match of Table Tennis was also played in 1926. This game was included in the Olympic Games in 1988.

**TABLE :**

The Table is rectangular in shape. It is 274 centimeters long and 152.5 cm in width. The height of the table is 76 centimeters. The sides of the table are 2 cm and have white-colored lines all around. Long lines are called Side-Lines and wide-side lines are called End Lines. The top surface of the table is called 'Sports Floor'. The table can be made of any substance.

But it (table) should yield a uniform bounce of about 22 to 25 cm to a standard ball when it is dropped on to it from a height of 30.5 cm.

*Table of Table Tennis:*

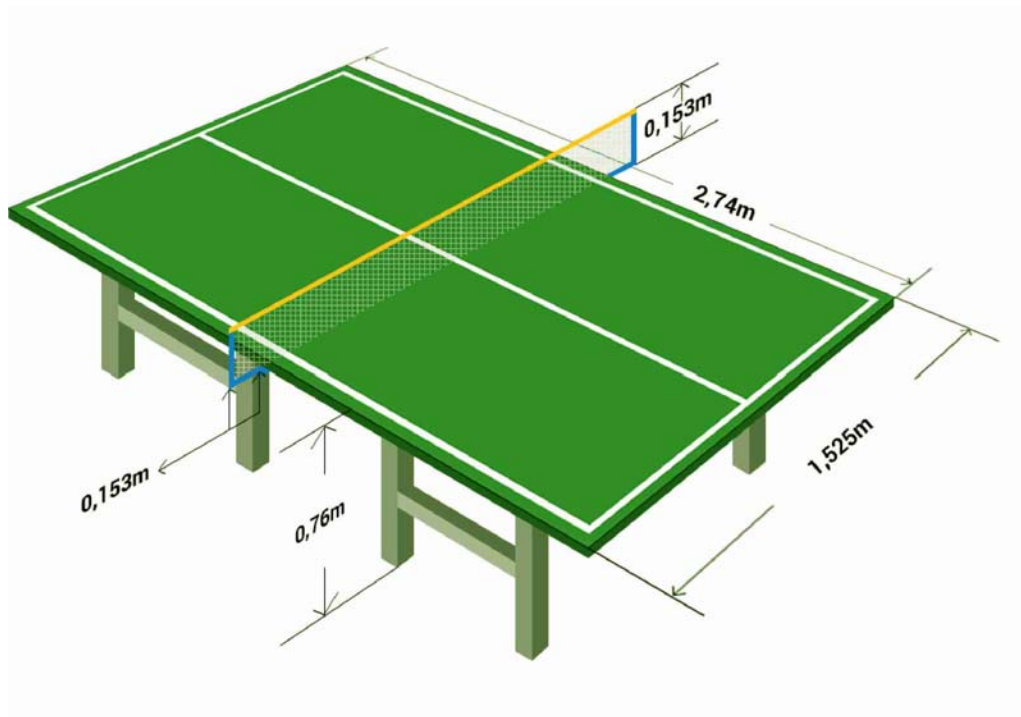

### **BALL :**

The shape of the ball is a round. It is made of celluloid plastic. It should not be more than 40 m.m in size/diameter. Its weight should be 2.5 grams to 2.7 grams.

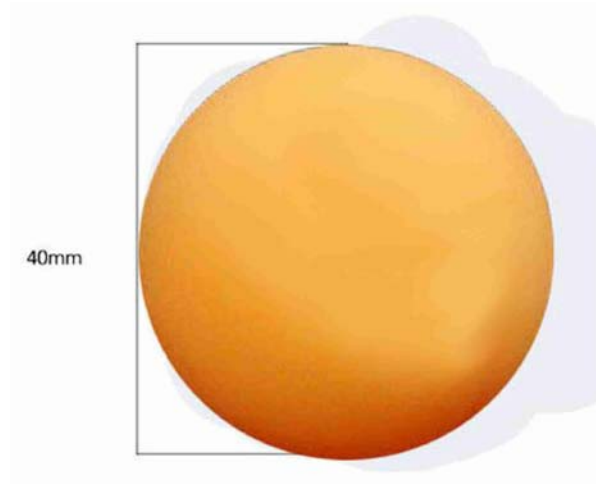

### **RACKET :**

It should be made of solid and any flat wood. One side of the racket should be black and the other side red. Its thickness should not be more than 4 m.m. Any player can check the racket of the opponent Player.



### **SERVICE :**

It is necessary for the player to keep his palm open while serving the ball. All the fingers of his hand will be gathered. The ball should be clearly seen by the referee when serving. The serving player tosses the ball in the air and hits it with his racket. The ball should touch the court surface without touching the Net assembly.

In the double game, the first bounce of the serve bounces once in the right half of the ball-serving player or the center line towards his net, touching the end of the net or near the straight end or touching the center line towards the right half of his opponent.

### **SINGLE GAME**

A player from both teams will participate in this format in Table Tennis.

### **ORDER OF PLAY**

Player serving in a single game consistently plays 2 services, irrespective of whether he scores or not. After this the opponent is given the opportunity to serve twice. So both the players alternate the service after every two points.

### **DOUBLES**

Player serving in double game serves and the opponent gives a good return. Now the serving team will serve the second player and the opponent will return.

### **THE BALL IN PLAY**

When the player serving the ball throws the ball to the opposite side of the net, the ball will remain in the game till :

- 1 The ball doesn't touch any side of the field twice.
- 2 Any player hits the ball more than once.
- 3 The ball touches the player or his/her clothes.
- 4 It touch every area extension when hit the racket except during services.

- 5 The ball returns without tossing on the tennis court.
- 6 Any other player strikes the ball.

### **GOOD RETURN**

The ball touches the opponent player's court when served by a player.

### **LET**

**Let means rest, whenever**

- 1 The ball touches the net in service/ while serving.
- 2 When the opponent of the player who's service it is not ready.
- 3 Player fails to make a service or a return due to some accident.
- 4 The game is to be stopped to correct any errors.
- 5 Play is interrupted by the umpire or assistant umpire.

### **SCORE**

**Score will be given to the opposite team when :**

- 1 No player breaks the service.
- 2 The player fails to correctly return the opponent player's service or return.
- 3 The player's racket touches the net, when the ball is in play.
- 4 The table surface is shaken during the game.
- 5 The player touches the bottom of the table with his free hand while playing the game.
- 6 The player strikes the ball before the ball tosses to the opponent player.



- 7 The ball doesn't touch both the players' as well as the opponent players' side of the court, while crossing the end line or side line before entering the play.
8. In a doubles' game, the player plays irrespective of his turn.

### **GAME**

The player or team that is first to score 11 points will be the winner. If both the players or teams score 10 points each, then both the teams or players will be cautioned turnwise while serving.

### **MATCH**

Match is of five games or seven games. Any player or a coach can take one time-out during the match. This time-out will not be more than five minutes between the third and fourth play in the match comprising five games. The rest in the reciprocal games will not be more than a minute.

### **SELECTION OF DIRECTIONS AND SERVICE**

The player who wins the toss is allowed to choose a service or a side.

### **EXERCISE**

- 1) What is the shape of a Table Tennis Table ?
- 2) How much is the height of the Table from the ground ?
- 3) What is the colour of the Table ?
- 4) How many officials are there in a Table Tennis game ?
- 5) Does the toss-winning player choose a service or a side ?

—0—

—(139)—

**LESSON - 5****HANDBALL****Things to Remember**

<b>S.NO.</b>	<b>DESCRIPTION</b>	<b>MEASUREMENTS</b>
1.	Length and Breadth of the Playground	40 mtrs. X 20 mtrs.
2.	Goal Area	6 mtrs.
3.	Free Throw line	9 mtrs.
4.	Penalty line	7 mtrs.
5.	Restraining line of Goal Keeper	4 mtrs.
6.	Substitute area	4.5 mtrs. from centre line to both sides
7.	Breadth of Marking line	5 cm and Goal line 8 cms
8.	Length and breadth of Goal Post	3 mtrs. X 2 mts.
9.	Match duration	30-10-30 mins for men and 25-10-25 mins for women
10.	Extra time	5-1-5 Mins
11.	Suspension of Player	2 Mins
12.	Max. time to hold the ball	3 Second
13.	Number of steps while holding the ball	3 steps
14.	Weight of the ball	425 to 475 grams for men 325 to 375 grams for women 290 to 330 grams for sub junior.
15.	Circumference of the ball	-58 to 60 cms for men-54 to 56 cms for women-50 to 52 cms for sub junior.
16.	No. of time out	Total 3
17.	No. of Players	16 (13 court players and 3 Goal keepers).
18.	Total officials	2-Referees, 1-Scorer and 1-Time Keeper.

### HANDBALL GAME GROUND

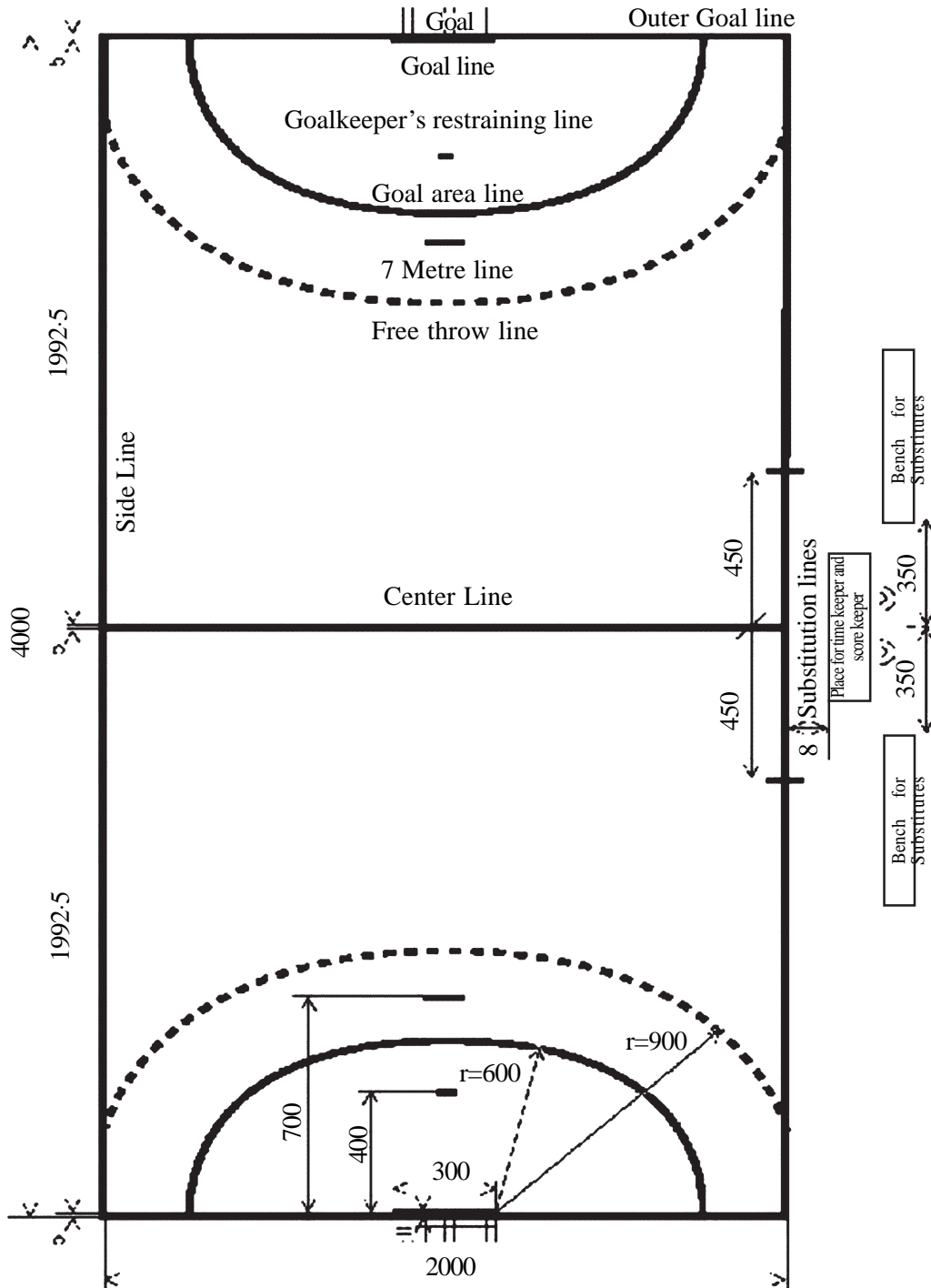

**GOAL POST**

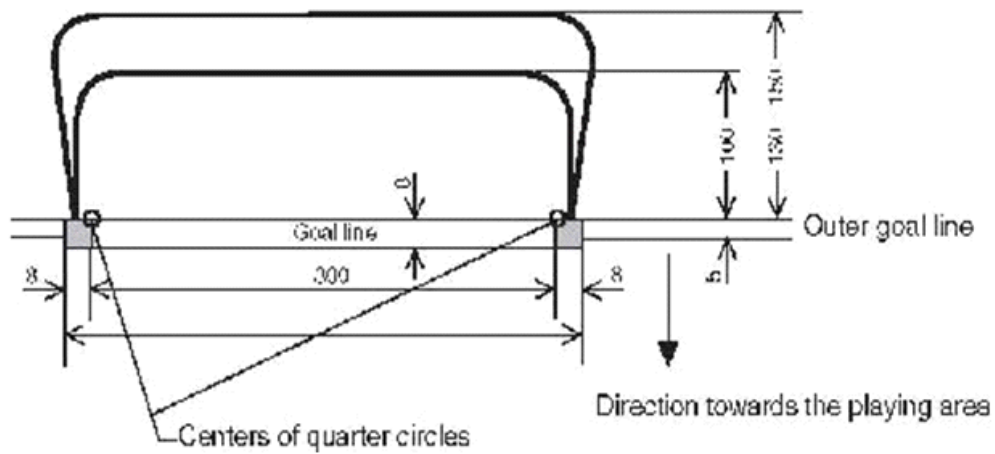
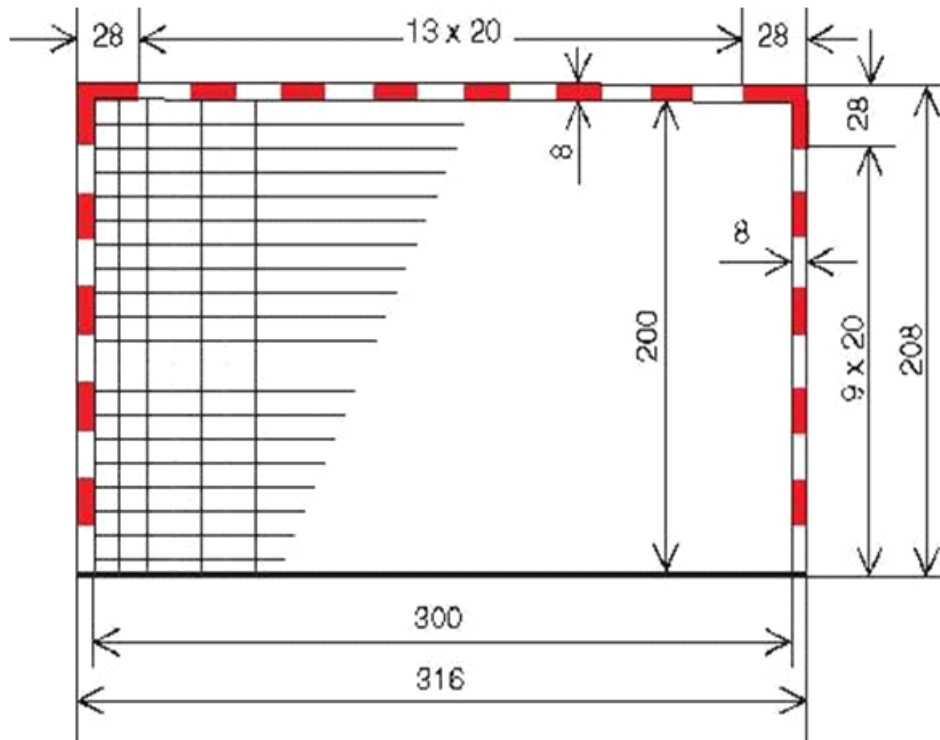

**1. PLAYGROUND :**

The length of the Playground is 40 mtrs. and the width is 20 mtrs. The Playground is divided into two parts of 20-20 mtrs. Each line has a thickness of 0.5 cms. The length of poles is 2 mtrs. and width is 3 mtrs. The round post of 6 m. and 9 m. is created forth the poles. Penalty area is at a distance of 7 m from the poles.

**2. OFFICIALS :**

The following officials are appointed for the game of Handball  
2- Referees, 1-Scorer and 1-Time Keeper.

**3. TEAM :**

The Handball team has a total of 16 members out of which there are 3 goal keepers and 13 court players. Seven players are in action of which 6 are court players and 1 goal keeper. Others are substitute players.

**4. GAME TIME :**

The time of the game is 30-10-30 for men and 25-10-25 for women.

**5. GOAL POSTS :**

The distance of poles from each other is 3 mtrs. Each pole is 2 mtrs. high. The thickness of Cross bar is 8 X 8 cm.

**6. GOAL AREA :**

There is a six-meter semi-circle on the final line on both sides of the playground, which is called the Goal Area. A player attacks while keeping out of this area.

**7. FREE THROW LINE :**

Outside the 6 meter D of the round area, another semi-circle of 9 mtrs. is created which is known as a free throw line. If there is a mistake made by a player in the round area or the free throw area, the attacking team is given a free throw as a compensation.

**8. PENALTY LINE :**

If the players of the attacking team face any dangerous foul, change of goal keeper in wrong way, etc, then the attacking team is given a 7-meter line to compensate the damage. A single player from the opposition defends the ball from the goal keeper without any protest.

**9. START OF THE GAME :**

The team that wins the toss selects either a side of the playground or a throw. At that time a player of the throw-in team touch the central line with his foot and starts the game with a pass with the whistle of the Referee.

**10. GOAL THROW :**

If the ball goes into the goal during the play, then a score is considered and the referee points to a goal by blowing the whistle twice.

**11. THROW IN :**

If the ball goes out from either side of the playground then the opposing team gets a throw-in and the player touch the side line and plays the ball .

**12. CORNER THROW :**

When the defender or goal keeper happens to make the ball go out of the final line, the opposing team gets a corner throw. This is done from the corner of either the end line or the side line .

**13. FREE THROW :**

If any player violates any rule of the game, the other team player is given a free throw .

**14. PENALTY THROW :**

If a player makes a foul in his area deliberately, or the game rule is seriously violated in his or her field or the opponent team is

trying to make a goal and the goal is clear certain but the player making the goal is stopped in an unfair way, or if a player of the defending team picks up the ball and enters his field / 'D', a penalty throw is given.

**The appraisal sensors used during the game :-**

1. Court Players inter in the Goal Area.
2. Wrong Dribbling.



3. Holding the ball for more than three seconds and taking more than three steps.
4. Holding and pushing the player.



5. Hitting.
6. Offensive Foul.

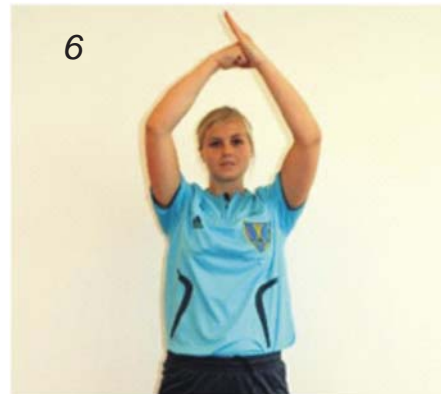

7. Throw in position.
8. Goal-keeper throw.



9. Free Throw position.
10. A gesture three meter from the player.





11. Passive Play.
12. Goal (sign of the score).



13. Warning (Yellow Card) and disqualify (Red Card).
14. Suspension for 2 minutes.



15. Sign of Time out.
16. Two players entering together in the ground.



### EXERCISE

- 1) Give the length and breadth of the Handball ground ?
- 2) Write about the Goal area of Handball game ?
- 3) Write about the Penalty area of Handball game ?
- 4) Give the weight of the ball for men ?
- 5) Give the number of time-outs ?
- 6) Give the total number of officials in a match ?

**LESSON - 6****FOOTBALL****To remember**

<b>Shape of Football ground</b>	<b>Rectangular</b>
The length of the Football ground.	100 yards to 130 yards (90 meter to 120 meter)
The width of the Football ground.	50 yards to 100 yards (45 meter to 90 meter)
The weight of the Football.	14 to 16 ounces
Diameter of the Football.	27 to 28 inches
Number of players in a Football team.	18 (11 players + 7 alternate players)
No. of players that can be changed in a match.	03
Duration of the Football match.	90 minutes (45-10-45)
Match officials.	1 Referee, 2 Linemen, 1-Timekeeper

**HISTORY :**

Football is the most popular game in the world. Although the birthplace of the modern Football game is believed to be England, yet countries like Greece and Rome consider Football as a violent game. Rules of football were first made in 1862-63 First National match of Football was played between England and Scotland in 1872. International Football Federation (FIFA) was formed on May 21, 1904.

**PLAY FIELD OF FOOTBALL GAME :**

The Football field is a Rectangle. The minimum length of the ground is 100 yards and the maximum length is 130 yards. The width of the ground can be at least 50 yards and its maximum width can be 100 yards. The minimum length of International matches is 110 yards to 120 yards and the width is 70 yards to 80 yards.

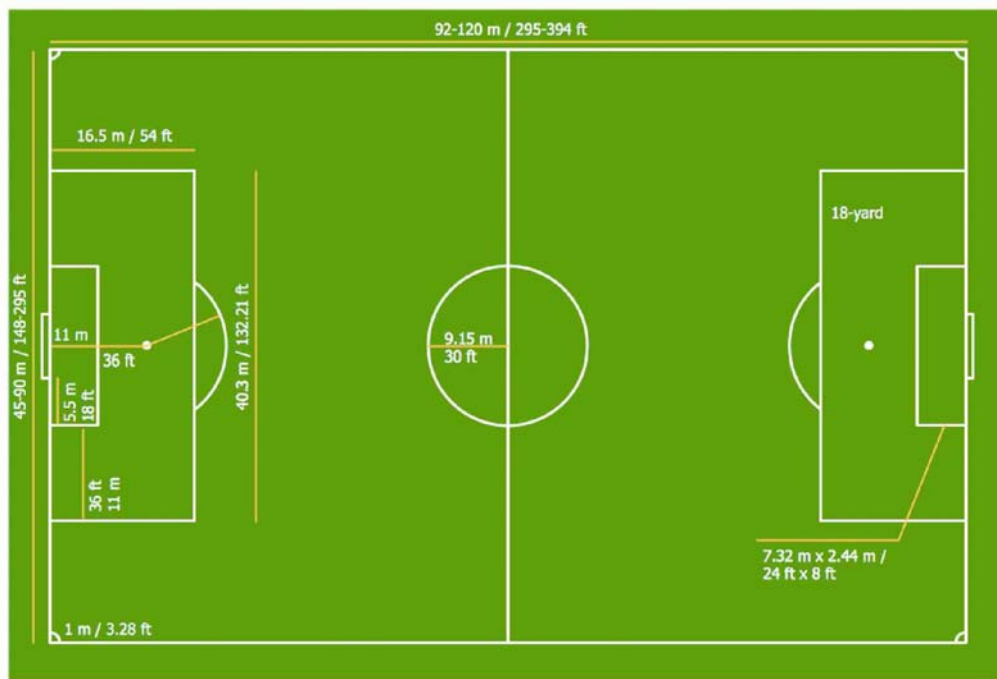

**LINES :**

The Playground lines should be clearly visible. Long lines of the ground are called side lines. Small lines are called Goal lines. Corner flags are mounted at a height five feet on every corner of the ground. On the central line of the ground, flag of a one yard height can be placed on both sides of the yard at a yard's distance. A circle with a radius of 10 yards will be drawn in the centre of the field.

### **GOAL AREA :**

Two lines are drawn on the right-hand corner of the goal line at both sides of the playground. These will be drawn at a distance of six yards and will be combined with a line parallel to the goal line. The area surrounded by these lines and circular lines is called Goal Area.

### **CORNER AREA:**

On each corner of the ground from the flag post, a quarter of a yard radius will be drawn within the playground.

### **PENALTY AREA :**

The line perpendicular to the goal post line will be drawn at a distance of 18 yards from the goal post at the both ends of the playground. The area inclosed between these lines and goal post lines is called Panelty Area.

### **BALL :**

The ball is round in shape. It is made of leather or any approved material. Its circumference is 27 to 28 inches and weight is 14 to 16 ounces. The ball cannot be changed without the permission of a referee during a match.



### GOAL POLES :

Two Goal poles will be placed at a distance of 4-4 yards from the center point of the goal lines. Then both these poles will be combined between the cross bar (ie the pillars), they will be 8 feet high from the ground. The width and thickness of the Goal post and cross bar will not be more than 5 inches.

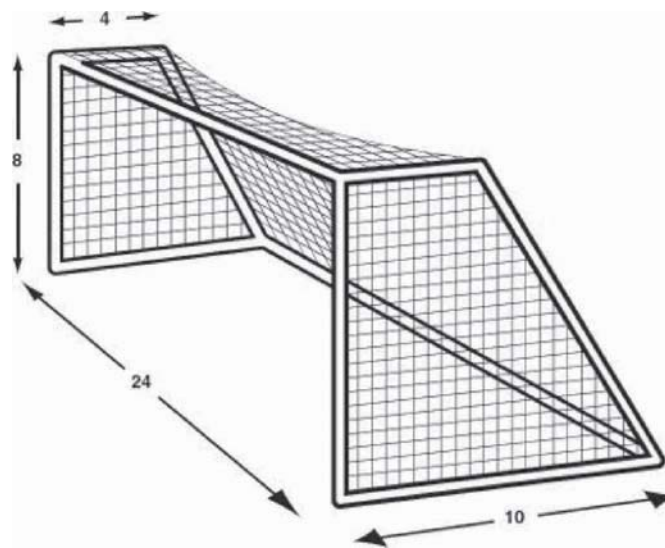

### NUMBER OF PLAYERS :

Football is played between two teams. Each team has 11 players and 7 extra players (Substitute). A team can change 3 players in a match. The alternate player can not participate in the game again.

### SPORTS GOODS FOR PLAYERS :

A player can wear T-Shirts, Shorts, Socks and Studs while participating in a Football match. The colour of the goal keeper's kit will be different from that of the rest of the team. In any match, players must wear Studs. None of the players can wear such an item that is harmful to other players.

### **GAME OFFICIALS :**

To play any match, a qualified Referee is very much required to ensure the play in accordance with the rules.

Referee-1,

Lineman-2,

Time keeper-1,

### **DURATION OF THE GAME :**

The game of Football is played in two halves of 45-45 minutes. A maximum of 15 minutes rest is given after first half. If the match is in a draw even after playing two halves of 45-45 minutes, then another match of 15 minutes will be played. If the match remains draw again, then 5-5 penalty kicks will decide the winner.

### **BEGINNING OF THE GAME :**

Before any match begins, the Referee calls both the team captains and allow to the toss-winning captain to either pick the side or kick the ball. After the kick, the match starts.

### **SCORE :**

When a team, while playing according to the rules of the game, takes the ball to the goal post and makes it cross the goal line, then it will be considered a goal.

### **OFF SIDE :**

There will be off side during the game.

1. When there are not many players from the half of the opposing team and there are no opponent behind them.

2. If they are not in their half ground of the ground.
3. If the opponent players are not close to their goal line.

**The player is not at off-side, when**

1. Player is not in the half ground of the ground.
2. The ball touches the player for last time.
3. He gets the ball in Goal kick, corner kick or the referee drops him.
4. The ball is played by the opponent player.

**THROW IN :**

When the ball crosses the side-line of the ground or in the air then the opponent player stands at that place from where the ball goes out. He while holding the ball with his both hands throws it overhead. The player who throws the ball cannot touch the ball until any other player touches it.

**KICK OFF :**

**Kick off is always started from center mark.**

1. At the start of the match.
2. After a goal is scored.
3. At the beginning of the second half. Every half (if additional time is given).

**Goals can be scored through kickoffs.**

**Free Kick :** Free kick is of two types.

1. Direct Kick
2. Indirect kick

**1. DIRECT KICK :**

Goal can be scored directly towards the opponent team by free kick.



- a. kicking the opponent player.
- b. Entangling with the leg of the opponent player to make him fall.
- c. Falling on the opponent player or to catch him.
- d. Hitting the opponent player.
- e. Deliberately handling the ball.

## 2. **INDIRECT KICK :**

A goal cannot be scored directly by an Indirect kick: But if another player touches the ball then a goal is considered.

### a) **Corner Kick :**

When the ball crosses the goal line after touching the player of the defending team, a corner kick is given. The player of the opponent team kicks the ball towards the goal post by placing it on the half circle of the flag post. The player of the opponent team stands at a distance of 10 yards while a free kick is being taken.

### b) **Goal kick :**

Whenever a team throws the ball across the goal line of the opponent team, and no goal is scored, then the opponent player kicks the ball out of the goal post. The ball will be considered in the game only when, the ball is out of the penalty area. The player who kicks the ball cannot touch the ball until any other player plays with it.

### c) **Penalty Kick :**

Penalty kick will always be taken from the penalty spot. When a penalty kick is being taken, only the goal keeper and the kicking player remain there.

**EXERCISE**

- 1) What is the shape of a Football ground ?
- 2) Define the length of the ground ?
- 3) Give the time duration of a Football match ?
- 4) What are the total number of players in Football team ?
- 5) What are the total number of spare players in Football team ?
- 6) How much is the weight of a Football ?

—0—

—(156)—

## LESSON - 7

**KABADDI****Things to Remember**

<b>S.NO</b>	<b>DESCRIPTION</b>	<b>MEASUREMENTS</b>
1.	Kabaddi ground length and breadth (For men) (For women)	13 meters 10 meters 12 meters 8 meters
2.	Kabaddi ground length and breadth (For Junior Boys) (For Junior Girls)	11 meters 8 meters 11 meters 8 meters
3.	Time duration of Kabaddi (for men) (for women)	20-5-20 minutes 15-5-15 minutes
4.	Half time	5 minutes
5.	Number of players	12 players
6.	Distance of the middle line from the Baulk line (for men) (for women)	3. 75mtrs 3.00 mtrs.
7.	Bonus number	Not less than six players

## **HISTORY :**

Kabaddi is the oldest game of India. This is a game of holding and touching. It is a International game. The first match of Kabaddi was played in Asian Games in 1982. Men's Kabaddi was played for the first time in the Asian Games of 1990 in which India won a Gold medal.

Besides India, this game is gaining popularity in other countries like Pakistan, Sri Lanka, England, United States, Canada, Thailand, Singapore, Malaysia etc..

From time to time, the rules of this game have also changed. The game was previously played on soil ground now this game is played on a synthetic rubber mat. It is now mandatory to play this game on mats in colleges and universities.

## **MAT**

The mat is made of Japanese synthetic rubber. The thickness of this mat is approximately 25 mm to 40 mm. This rubber mat is laid down in 20 X 20 or 19 X 18 meter format. Then Kabaddi ground is made on it.

## **GROUND**

### **BOUNDARY LINE**

This line is located around the ground. The thickness of this line is 3 to 5 cms. The rest of the lines are marked within this boundary. The dimensions of the boundary are 13 X 10 meters for men and 12 X 8 meters for women, not including the box meant for sitting.

### **GALLERY**

It is placed length wise at a distance of 1 meter from the boundary line on each side. This gallery is a part of the ground, but can

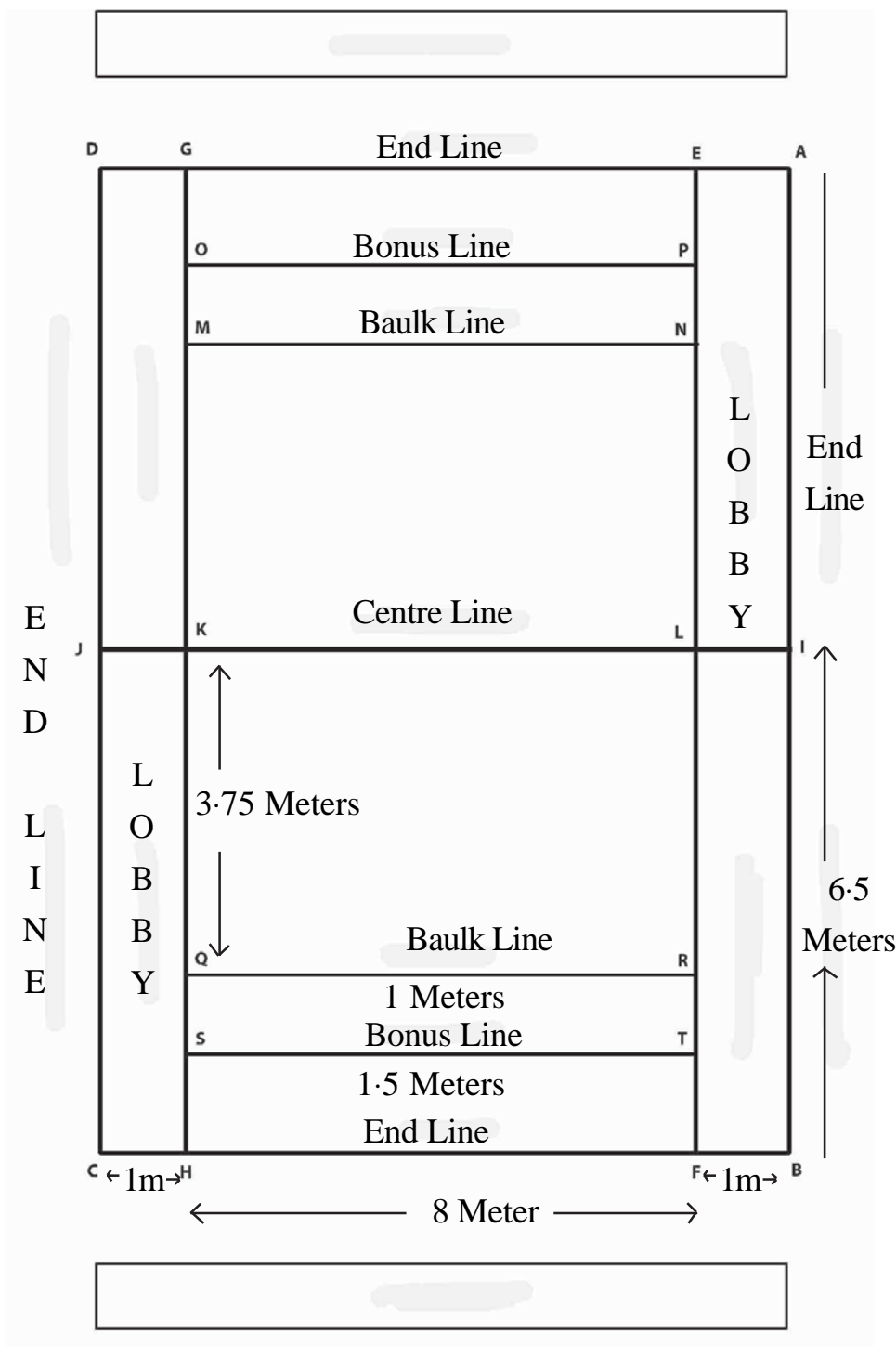

only be used during struggle, i.e when a Raider takes a number or is captured. If during a match, the Raider returns without touching an opponent player in the gallery, or if an opponent player touches the gallery lines, he is considered out

### **CENTRE LINE :-**

This line divides the ground into two parts. One half of the ground belongs to one team and the other half is for the second team. This line is also called the Center Line, during a match.

### **BAULK LINE :-**

It is present between the End line and Center line.

The Raider is required to cross this line. If the raider fails to touch an opponent players or even if he fails to cross this line, he is considered to be out and the opponent team is given a point. This line is laid at a distance of 3.75 meters from the center line for men and at a distance of 3 meters for women as well as junior boys and girls.

### **BONUS LINE :-**

Bonus line is placed at a distance of one meter equivalent to the baulk line. The bonus line can be used by the raider when 6 or 7 players of the opposing team are in the ground. When the raider starts a raid, he is required to cross this line. If he crosses it correctly the raider gets a bonus point.

### **AGE LIMIT :-**

- Senior men and women - no age limit
- Junior boys and girls - Under 20 years
- For sub junior boys and girls - Under 16 years

**Weight of Kabaddi player :-**

- 1) For Men : 85 kilograms or less
- 2) For Women : 75 kilograms or less
- 3) Junior boys : 70 kilograms or less
- 4) For Junior girls : 65 kilograms or less
- 5) For Sub-junior : 55 kilograms or less

**Weight in National School Games :-**

- 1) Under 19 year boys : 70 kilograms
- 2) Under 19 year girls : 65 kilograms
- 3) Under 17 year boys : 55 kilograms
- 4) Under 17 year girls : 55 kilograms
- 5) Under 14 year boys : 51 kilograms
- 6) Under 14 year girls : 48 kilograms

**OFFICIALS :-**

5 officials (Referee-1, Umpire-2, one assistant and one scorer).  
The match Referee also keeps record of the time.

**LONA :-**

When all the players out of the playing team are being dismissed, then the opposing team gets 2 points, which is called Lona.

**GENERAL RULES :-**

- 1) There are 12 players in each team out of which 7 players play.
- 2) The time of the game is 20-5-20 for men and 15-5-15 minutes for women.

- 3) Toss is done before the start of the match. The winning team is allowed to either choose the side or draw a raid. After half time pass players are replaced.
- 4) If the match is not completed due to some reason, then it is played again.
- 5) Players can not play matches while intoxicated.
- 6) Players can not apply oil or cream on their body or wear bangles or any kind of sharp objects.
- 7) If the Raider gets out ,the opposing team is given a point. The team which is able to lend , is awarded an extra two points. Number of points , equivalent to the number of players touches by the raider are awarded to the raiding team.
- 8) A Raid is of 30 seconds duration during which the raider is required to chant “Kabaddi Kabaddi”.
- 9) When the Raider returns to his ground after a raid, the opponent team has to start the raid within 5 seconds. If they are late, the Raid is canceled.
- 10) Only a single player can start a raid on the opponent team.
- 11) If the Raider does not speak or chant kabaddi-kabbadi continuously, then he is considered to be out.

### **FOULS :-**

The Referee or umpire has the power to make a player aware of the following violations, to give points against him, and to dismiss him.

1. Trying to break the breadth of the raider by pressing down on his throat.
2. Violently Attacking.
3. Holding the clothes or hair of the opponent.



4. Holding the raider by any unfair way, or pushing him out of the ground.
5. Receiving instructions from the coach or a player outside.

**The Referee or Umpire can dismiss a player if he commits a foul, or punish him by giving one of the following cards :**

1. Green card : Warning
2. Yellow card : 2 minutes out of the match
3. Red Card : Dismissal from the entire match.

### **THE MAIN SKILLS :**

Kabaddi is a game of touching and catching, so tricking and tackling in the game is a must. Strength, agility and flexibility are essential qualities required in the player. Touching the opponent, knocking on the back, touching while crouching or while laying down, jumping and flipping, holding the Raider from the ankle with a jig, etc. are some defensive skills, too.

### **EXERCISE**

- 1) Give the length and breadth of a Kabaddi Ground ?
- 2) What is the time duration of a game for men ?
- 3) How many minutes does the half time comprise ?
- 4) Give the distance of Baulk line from the mid line for men ?
- 5) Give an account of the history of Kabaddi ?
- 6) What is meant by a gallery ?
- 7) What is meant by a Baulk line ?

—0—

—(163)—

## LESSON - 8

**CIRCLE STYLE KABADDI****Things to Remember**

Total number of players	14
Match Players	8 Playing and 6 Substitute
Match time	20 min each
Rest time	5 minutes
Timeout	2 time out(s) in one half
Duration of Time out	30 Seconds

**1. PLAYGROUND OF CIRCLE KABADDI :**

Playground of Circle Kabaddi is made of soft synthetic mats. It has a circumference of 22 meters (72 feet) for males and 16 meters (about 52 feet) for women. Gray Ground lines are marked at least 3 cm thick and 5 cm wide. Additional space of at least 3 meters is left outside the ground.

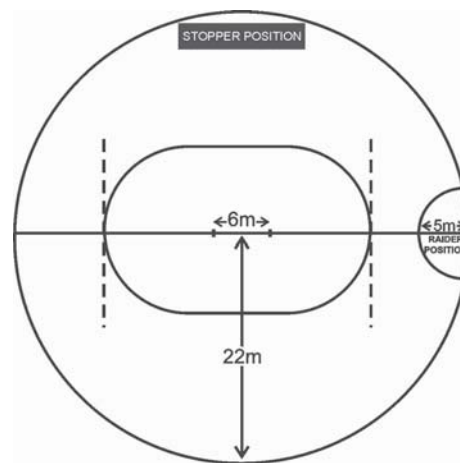

—(164)—

## **2. MIDDLE LINE :**

The line that divides the field into two parts is called the Middle Line.

## **3. COURT :**

Each section of the playground is divided by a line from the centre, which is called the Court.

## **4. RAIDERS' PLACE TO STAND :**

A 5 meter curve area is marked on both sides of the centre line for the Raiders to stand in.

## **5. PALA :**

'Pala' is also called the Centre Line and the Playground Centre Line. It extends from the central point or centre line on both sides (6 meters total). A Raider reaches his court safely using this pala. The pala is made of any soft material or lime powder. Its diameter is 15 centimeters and height 20 cm. This is same for all age groups.

## **6. AGE CATEGORY AND WEIGHT :**

There is no restriction of age and weight in men's and women's category.

- i. Junior boys below 20 years and weighing upto 75 kg
- ii. Sub-Junior girls and boys less than 20 years and weighing upto 70 kg.
- iii. For sub junior boys and girls the age limit is less than 16 years and weight upto 65 kg.

## **7. SPECIAL TERMS USED IN KABADDI :**

- i (CANT) player has to utter the word "Kabaddi" continuously in a high and accurate pronunciation without break. This is called a Cant. It's maximum time limit is 30 seconds.
- ii. Holding the Raiders: If a defender can catch a Raider without

breaking any rules, the Raider holds him in his court for 30 seconds until the CANT breaks.

- iii. Arriving Safely in One's Court: If a Raider reaches his court within 30 seconds without breaking the cant and any rule, then it is called Safe Access.

#### **8. RULES OF CIRCLE KABADDI :**

- i. The team which wins the toss has the opportunity to take a court or a Raid. After half-time the court is changed and the other team is given the opportunity to Raid first.
- ii. Raiders of both teams stand in Raiders' Zone. If any Raider comes out of this area, the other team gets a technical point.
- iii. 4 Stoppers are a must in the chain and they can not break the chain during the raids. If they do so, the point is given to the other team.
- iv. Before the Raid starts, the stoppers will stand near the End line in front of the Pala. After the Raid starts, they can move the chain or take it anywhere.
- v. In Circle Style Kabaddi, the Raider can touch only one Stopper. If he touches more than one Stopper, the other team gets a point.
- vi. No Raider can make two consecutive Raids. It is necessary to have a gap between two Raids.
- vii. Only a stopper can stop the Raider. If more than one player do so, then the point goes to the stopper.
- viii. During the struggle whosever player crosses the middle line first, then the point goes to the opponent team.
- ix. The Raider cannot throw the Stopper out by pushing him intentionally. If he does so, the opponent team is given a point.

- x. If the players cross the middle line or the end line during the struggle, then no team is given a score. In this situation, if the Raider crosses the pala, he is given one score.
- xi. If the Stopper is out of the End line, holding the raider, then the Raider is given a safe and is given a score against the Stopper.
- xii. If the Raider continues his Raid for more than 30 seconds, then he is called back and the opponent is given a point and a chance to raid.
- xiii. If the raider becomes incapable of taking his Raid during a fixed period, the Referee or Umpire calls him back and the opponent team gets a technical score.
- xiv. Not more than one Raider can enter the field of the opponent team, if they do so the Referee or Umpire calls them back.
- xv. After one team has finished the raid, the other team has to make their Raiders Raid within 10 seconds. If the Raider fails to Raid, he loses his time and the opponent team gets a technical point and a chance to raid.
- xvi. When the Raider is stopped by the Stopper by use of any wrong method, like shutting his mouth or hitting him dangerously, then the Referee or the Umpire give a “safe” to the Raider.
- xvii. No Stopper can touch the Raider’s court during the Raid, if the Stopper or another player of the team does so, the Raider is given a point.

#### **9. MANAGEMENT OF THE GAME :**

In Circle Style Kabaddi, no player goes out of the field after being out, only points are counted.

#### **10. PRODUCTIVE RAID :**

A player has to earn a score on each Raid even if it is a Toss

Score, a technical score, the player is himself out, or if the Raider is captured. When the stopper or Stopping players drop themselves out, it is also considered to be a Raid. Its raider is given a score. If the Raider return safely in his own lona without getting a point, then the opponent team gets a score. Even if the Raid lasts longer than 30 seconds, the opponent team is given a point.

**11. SUBSITUTE PLAYERS :**

1. In a team there are six alternative players who are replaced with referee's permission. 2. A player once replaced can be replaced again. 3. If no player is declared suspended or disabled, then no alternative player can be taken in his place. The team will have to play with less player.

**12. RESULT :**

The team that earns more point, is declared winner.

**13. TIE IN KNOCK OUT MATCH :**

If the knock out match is in a tie then the tie-break is done as follows:

- a. Both the teams will have eight players and each team will be given 5-5 Raids.
- b. The team which has taken the first Raid at the start of the match will be given the first raid.
- c. If the match remains undecided after 5-5 Raids, then the tie is broken by Golden Raid

**14. GOLDEN RAID RULE :**

- a) If the match remains in a tie after 5-5 Raids then the toss is done between the teams. The toss winning team is given the chance of Golden Raid.
- b) If the match remains in a draw after the Golden Raid then the opponent team is given the chance of Golden Raid.

- c) The team which first gets more points in Golden Raid is declared the winner.

**15. WARNING CARD :**

There are 3 types of warning cards in Kabaddi.

a) **Green card :**

It is a warning card. If a player gets a green card for the second time, then it is turned into a yellow card.

b) **Yellow card :**

The player is taken out of the match for two minutes with a yellow card. If a player gets a yellow card twice in a game then it is turned into a red card.

c) **Red Card :**

The player is fired out of the match with a red card. If a player gets this card twice, then he is taken out of the entire tournament. The player can not play any match.

**EXERCISE**

- 1) What are the difference between Kabaddi and Circle style Kabaddi ?
- 2) How many players are there in Circle style Kabaddi ?
- 3) How much is the rest time (or time for rest) ?
- 4) What is the duration of the time out in a Match ?
- 5) What is the duration of the Match ?
- 6) What do you mean by Red Card ?
- 7) What are the types of Warning Cards ?

—0—

—(169)—

## LESSON - 9

## BOXING

S.NO	DESCRIPTION	MEASUREMENTS
1.	Shape of the Boxing Ring	Square
2.	Each side of the Boxing Ring	20 feet × 20 feet (within ropes)
3.	Officials	Judges (maximum 5 or 3), Timekeeper-1, Referee-1, Gong Operator-1, Supervisor-1, Announcer-1, Recorder-1
4.	Weight of Boxing gloves	10 Ounces, 12 Ounces
5.	Number of ropes in the Ring	4 Ropes
6.	The colour of the corners of the ring	1-Red, 1-Blue, 2-White
7.	Round time	3 rounds (3 minutes for each round)
8.	Rest time	1 minute (after every round)
9.	Radiation of Ropes	1. 40 cm, 2. 70 cm from the floor of the ring. 3. 100 cm 4. 130 cm
10.	Length of the bandages	2.5 meters
11.	Bandages width	5 centimetres
12.	Boxer's Technical Name	Pugilits



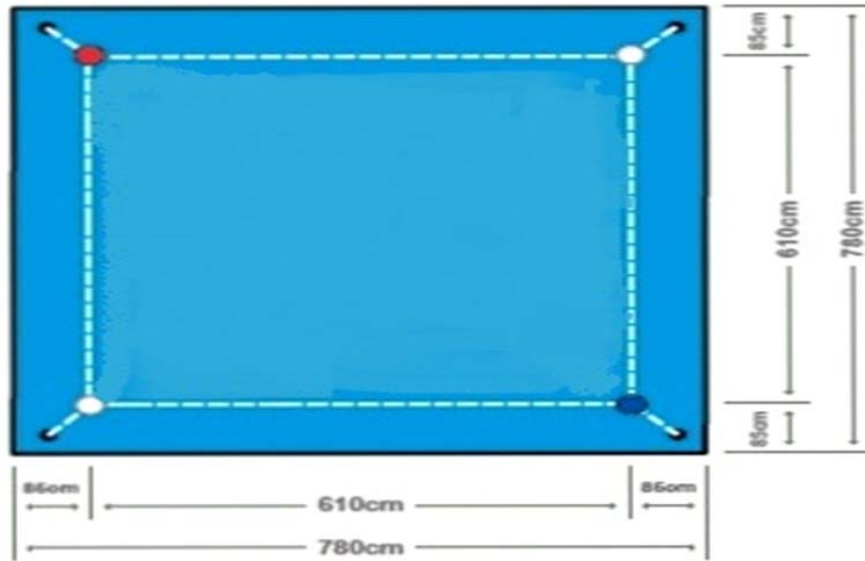

(BOXING RING)

**BOXING RING :**

Boxing platform should be 100 centimeters high from the ground.

**CORNER PAD :**

The four corners of the ring are facing down. One of these is red , one blue and two white .

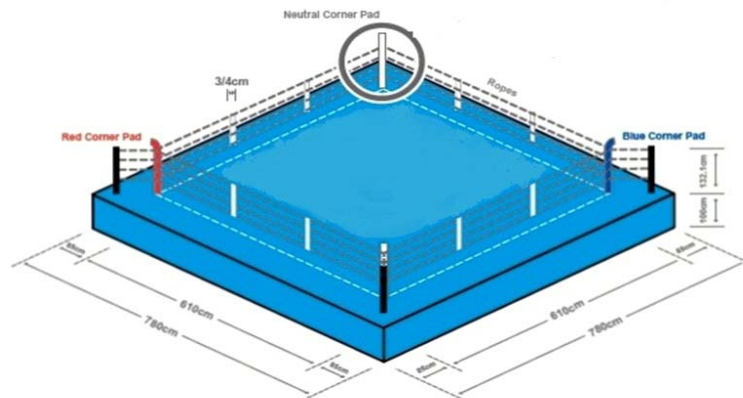

(CORNER PAD )

### FLOOR :

The floor of the ring is covered with rubber or soft items the thickness of which should be ranging from 1.5 cm to 2.0 cm.

### ROPES :

Four ropes of 4 cm each are rugged around the ring which is further covered with soft and thick pads. The distance between the ropes and ring must be (1) 40 cm, (2) 70 cm, (3) 100 cm and (4) 130 cm.

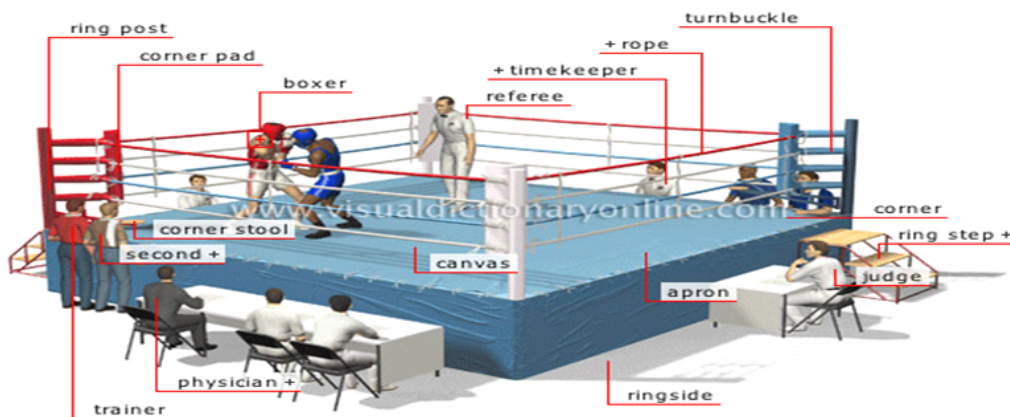

*(BOXING RING, LABELLING)*

### STAIRS :

The ring has three sided stairs. 'Red' in one corner, 'Blue' in other corner and 'White' in yet another corner which are for use by doctors, officials, guests and press.

### BOXER'S COSTUME :

Boxer has to wear Red or Blue shorts and vest. Boxer can wear ring shoes too. As per the draw sheet, if the name of a boxer is announced at first place then the boxer is to wear red costume and if at second place, then blue costume.

### **GLOVES :**

1. From Light fly weight (49 kg) to light welter weight (64 kg), 10 ounce gloves are worn.
2. From Welter weight category (69 kg) to super heavy weight category (+ 91 kg) , 12 ounce gloves are worn.

### **GUM SHIELD (TEETH GUARD) :**

It is mandatory for a boxer to wear a teeth guard during a bout. Red or related coloured teeth guard cannot be worn.

### **CUP PROTECTOR :**

Cup protector is worn by a boxer to protect his personal parts against any injury. But this cup protector should not cover any target area.

### **1. REFEREE :**

It is the responsibility of the Referee to conduct the bout of both the boxers in the ring according to the rules, by protecting the weak boxers from injury and keeping the entire bout under his supervision. In the ring, the Referee checks the full dress of the boxer viz. Gloves, Teeth guard, Cup Protector (for men), Bandages, Headgear, Shoes etc.

#### **The words used by the referee in the ring :-**

1. “Stop”: to prevent the boxers from fighting.
2. “Box”: to start the fight between the boxers.
3. “Break”: to cease the fight between the boxers
4. “Time”: Asking the time keeper to stop the time.

**2. JUDGE :**

During a bout, the judge records the score of both the Boxers and marks it on the score sheet and gives the decision. During a bout, the judge can't point out to a Boxer or to another judge. He cannot even leave his seat unless the bout is concluded.

**1. DOCTOR :**

It is mandatory to have a doctor available near the ring during a boxing tournament. The doctor examines the Boxers before they participate in the game. He conveys his decision to either jury or referee in case a boxer receives any cut or injury.

**2. TIMEKEEPER / GONG OPERATOR :**

The Time Keeper's and the Gong Operator's duty is to keep track of the time of each round and that of the comfort time given during a round.

**3. ANNOUNCER :**

During a tournament, the announcer keeps record of the type of bout, weight category, boxer's name, country or state name etc.

**4. COACHES / SECONDS :**

Coach as decided by the AIBA alone can go with the Boxer as a second (second means supporter to the boxer). 3 seconds can go with the boxer. Out of them 2 stay out of the ring and only one second can enter the ring during comfort or break time.

**5. SCORING SYSTEM**

Scoring is done on the basis of 10 in all bouts. At the end of every bout, the winner gets 10 points while the loser gets either 9 or 7 points.

Scoring    10 versus 9    : close round  
              10 versus 8    : clear winner  
              10 versus 7    : total dominance

For scoring, maximum 5 judges are on the outside of the ring, out of which the decision of the three is accepted and there are at least 3 judges, out of which the decision of two is accepted.

### **DECISION :**

- 1) WP (Win on points): the overall points scored by a Boxer make him winner.
- 2) SD (Split decision by Points): three judges declare one Boxer as winner while the other 2 judges declare the second one as winner.
- 3) RSC (Referee stops contest) Referee stops fight in case the boxer is injured or in order to save new or unaware Boxer from injury.
- 4) DSQ (Win by disqualification): When the Boxer defies rules repeatedly.
- 5) KO (Win by knock out): Knocking down of one Boxer by the other in the ring.
- 6) WO (Win by walk over): When one boxer does not report in the ring then he is given 1 minute to report, but if he still doesn't come then the other boxer is declared winner.
- 7) NO (No contest): Referee stops bout owing to lack of light, external interference, any manipulation or natural disaster like Rain or Storm.

### **DRAW :**

Draw is held in every weight category as per the number of boxers. Each boxer wears 'Red' or 'Blue' costume according to the draw sheet.

**BOUTS AND BYES**

<b>Number of Boxers</b>	<b>Byes</b>	<b>Bouts</b>	<b>Number of Boxers</b>	<b>Bouts</b>	<b>Byes</b>
5	3	1	14	6	2
6	2	2	15	7	1
7	1	3	16	8	—
8	—	4	17	1	15
9	7	1	18	2	14
10	6	2	19	3	13
11	5	3	20	4	12
12	4	4	21	5	11
13	3	5	22	6	10

**WEIGHT CATEGORY IN SCHOOLS**

<b>Under 17 Boys in school Total=13</b>	<b>Under 17 girls Total=15</b>	<b>Under 19 Boys Total=11</b>	<b>Under 19 girls Total = 12</b>
-46 Kg	-42 kg	-46 kg	-45 kg
46-48 Kg	42-44kg	46-49kg	45-48kg
48-50 kg	44-46 kg	49-52 kg	48-51 kg
50-52kg	46-48 kg	52-56 kg	51-54 kg
52-54 kg	48-50 kg	56-60 kg	54-57 kg
54-57kg	50-52 kg	60-64 kg	57-60 kg
57-60 kg	52-54 kg	64-69 kg	60-64 kg
60-63 kg	54-57 kg	69-75 kg	64-66 kg

63-66 kg	57-60 kg	75-81 kg	66-69 kg
66-70 kg	60-63 kg	81-91 kg	69-75 kg
70-75 kg	63-66 kg	+91 kg	75-81 kg
75-80 kg	66-70 kg		+81 kg
+80 kg	70-75 kg		
	75-80 kg		
	+80 kg		

### DEFINITIONS USED IN BOXING :

**1. AIBA :**

Amateur International Boxing Association.

**2. COMPETITION OFFICIAL :**

Persons who are appointed Referee, judge, chief supervisor, doctor and technical officer by AIBA.

**3. BOXER :**

A player who is a registered member with AIBA.

**4. FIELD OF PLAY :**

Boxing ring which has four 6.10 m long sides.

**5. GLOVES :**

The playing equipment which the player wears in hands, defends and attacks with it during bout.

**6. HEAD GUARDS :**

Equipment worn by a player on head during a bout.

**7. BOUT :**

Fight between the two boxers.

**8. CHIEF SUPERVISOR :**

One such official who is responsible for conducting the tournament as per rules and regulations.

**EXERCISE**

- 1) What is the technical name used for a Boxer ?
- 2) How many weight categories were there in under -17 boys competitions(Matches) ?
- 3) What is the full form of RSC ?
- 4) What is the full form of DSQ ?
- 5) What is WO ?
- 6) What is the duration of a single round in a Boxing match ?
- 7) What is the colour of the corners of a Boxing ring ?

—0—

—(178)—



**LESSON - 10****BASKETBALL**

<b>S.NO</b>	<b>DESCRIPTION</b>	<b>MEASUREMENTS</b>
<b>1.</b>	Length of Basketball Court	28 mtrs.
<b>2.</b>	Width of Basketball court	15 mtrs.
<b>3.</b>	Total number of players playing in a team	12 players
<b>4.</b>	Number of players playing a match	05 players
<b>5.</b>	Substitute players	07 players
<b>6.</b>	Radius of ball (For Men) (For Women)	74.9 cm 78 cm, 72.4 cm 73.7 cm
<b>7.</b>	Ball weight (For Men) (For Women)	567 grams to 650 grams 510 grams to 567 grams
<b>8.</b>	Time of Basketball game	40 minutes (total four sets) 10-2-10-10-10-2-10
<b>9.</b>	Time out (30 seconds)	2 time outs in the first half, 3 time outs in the second half, 1 time out in the extra time
<b>10.</b>	Officials of basketball game	1-Table commissioner, 1-Referee, 2-Umpires, 1-Scorer, 1-Assistant Scorer, 1-Time Keeper, 1-way clock operator

## BASKET BALL COURT

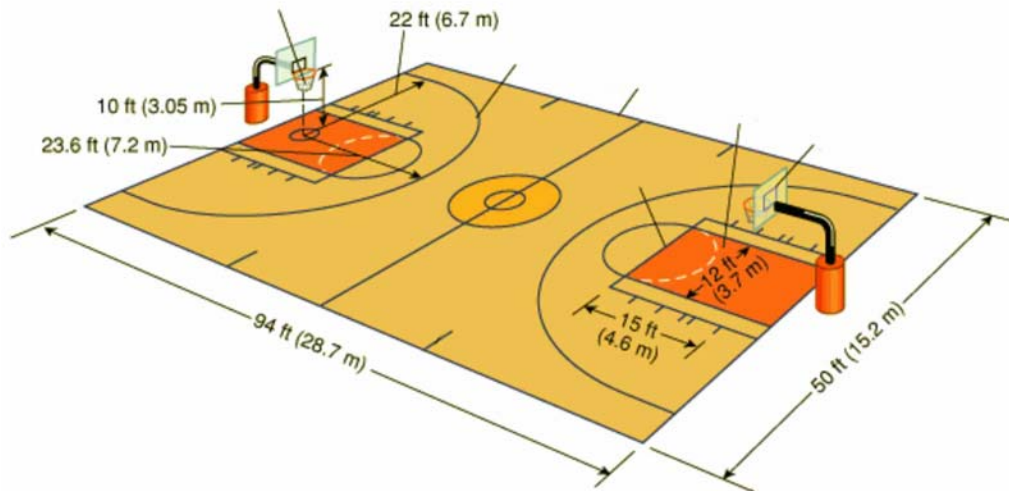

### 1. BASKETBALL COURT :

Basketball Court is marked with 5 cm thick lines. Its length is 28 mtrs. and width is 15 mtrs. The spectators/viewers seating gallery should be 2 mtrs. away from the ground. The indoor ceiling for the indoor basketball court should be 7 meter high.

### 2. BASKETBALL BOARD :

Basketball Board is made of a single piece of transparent glass fibre. Its length is 1.80 mtrs. to 30 m.m maximum and width is 1.05 mtrs. (+ 20 m.m max). In between Basketball Board there is rectangle of 59 cm length and 45 c.m breadth, and below this rectangle there is a ring on its lower edge. The board will be within 1.20 mtrs. from the final line of the court. The pole of the board will be outwards 2 mtrs. behind the last line.

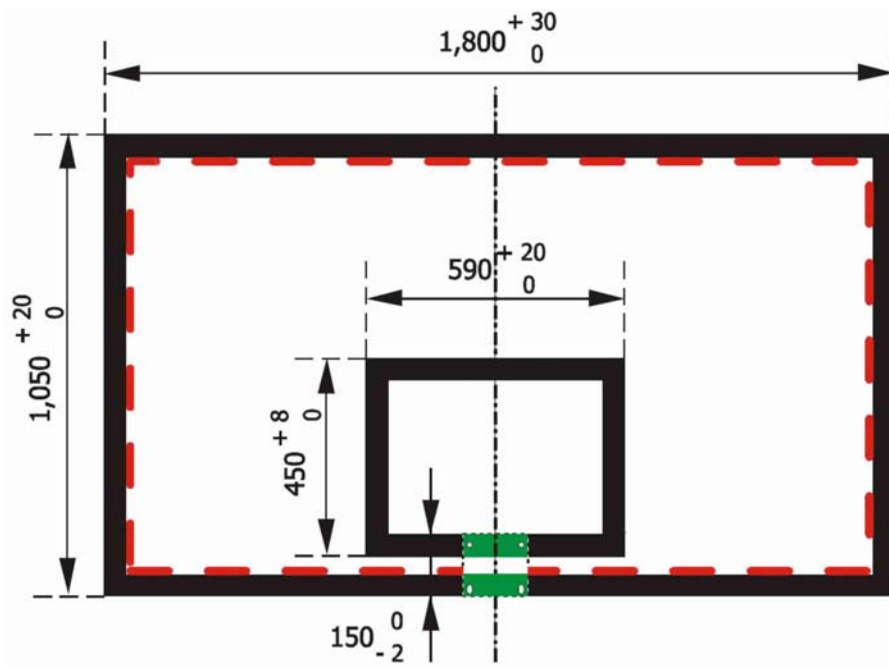
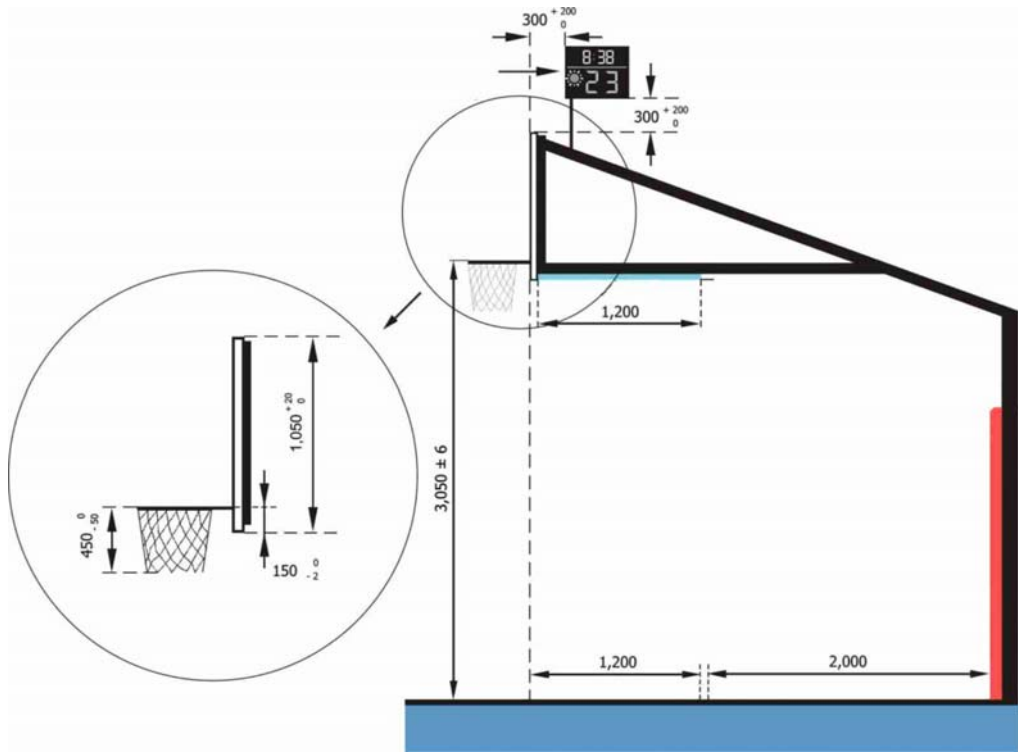

### 3. BASKETBALL RING :

Basketball ring is made up of steel or iron. Its diameter is 45 c.m to 45.9 c.m maximum. It has a minimum thickness of 16 m.m and a maximum of 20 m.m. The net will be tied on 12 sides with each ring. The ring will be fixed with the board, which would be at a 15 c.m distance from the board.

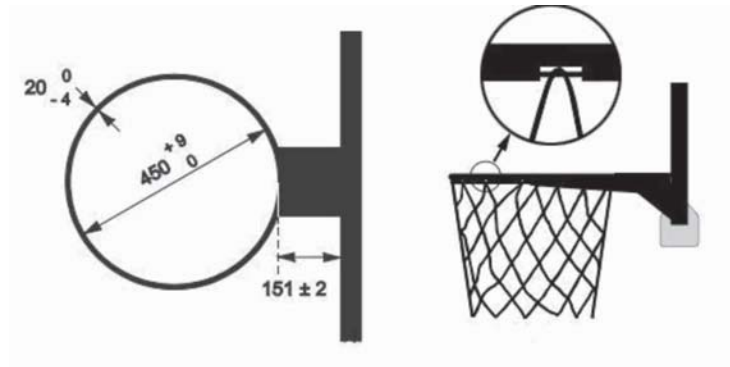

*Basket Ring*

### 4. TECHNICAL EQUIPMENT :

To organize the basketball game, there must be following technical equipments.

- 1) Game Clock
- 2) Balls
- 3) Big Score Board
- 4) Shot clock
- 5) Stop Watch
- 6) Score Sheet
- 7) Player Foul Marker
- 8) Team Foul Marker
- 9) Alternating Possession Arrow



*Game clock shot clock*

**5. TEAM :**

There are 12 players in each team, of which 5 players play a match. It is necessary for each team to put on a sports kit and 10 c.m long number in the front and 20 c.m long number at the back must be written. Their thickness should be of 2 c.m and they should look clean. Team members can use numbers 0 to 00 and 1 to 99 for their T.Shirts. Members of a team can not wear the same number of T.Shirts or kits. Each team member should have at least 2 sets of T.Shirts. One of them should be light coloured and the other dark colored.

**6. COACH :**

The coach submits the list of names and number of players, who are able to play the match, to the scorers, before the game starts. The players whose names are in the list, can take part in the game, even if they come after a short time from the start of the game.

**7. CAPTAIN :**

A good player is selected as a captain by the coach. The captain leads his team during the game. The captain works as a connecting link between the officials and the players on the court.

**8. TIME OF THE GAME :**

Basketball game is divided into 4 (four) sets. Each set is of 10 minutes duration. There is a two-minute rest between the first and the second and, the third and the fourth set. After 20 minutes of game there are 15-minutes for rest. If the match is in a tie, then an extra time of 5 minutes is given. This time continues till the tie break is done.

**9. START OF THE PLAY :**

The start of the game does not take place until 5 players of each team are present in the court.

**10. JUMP BALL :**

To start the game, the Referee makes a toss between two players of opposite teams, which is called Jump Ball. Immediately after this the game starts.

**11. LIVE BALL :**

There is a live ball during the Jump Ball, Free Throw and Throw In.

**12. DEAD BALL :**

It happens when the free throw is made. When the official stops the ball by blowing a whistle, then the free throw does not enter the baskets.

**13. THROW IN :**

When a foul takes place, the game is stopped by the umpire. The other team gets the ball for throw in from the near side line.

**14. ALTERNATING POSSESSION :**

It is a procedure through which the ball remains in the game by throw in only without repeating jump ball.

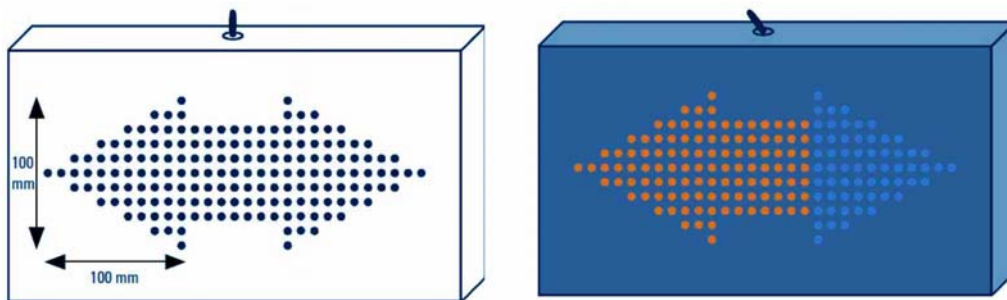

*Alternating Possessing Arrow*

**15. FREE THROW :**

Free Throw is a chance for a player, by which he can make a score from the free throw line without any opposition or resistance.

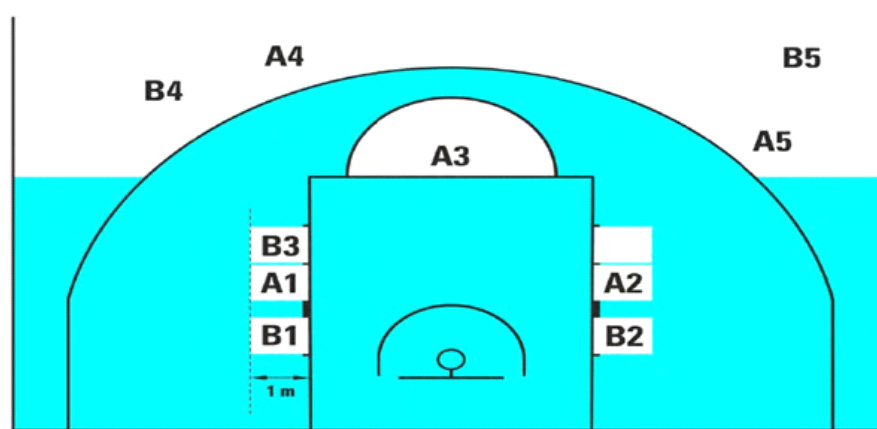

**16. 3 SECOND RULE :**

According to this rule, no player can stay in the prohibited area of his opponent team for more than 3 seconds, when the live ball is in control of his team.

**17. 5 SECOND RULE :**

According to this rule, no player can hold the ball for more than 5 seconds to pass, score or dribble.

**18. 8 SECOND RULE :**

When a team takes the throw in ball from the end line of its own court then it is mandatory for the team to cross the court within 8 seconds.

**19. 24 SECOND RULE :**

When a team takes the throw in ball from the end line, then it is mandatory for the team to try to score on the opponent's basket within 24 seconds.

**20. BASKETBALL FOULS :**

**1. PERSONAL FOUL :-**

The personal foul is committed when a player accidentally pauses or touches his opponent player. At this time the ball is

either dead or alive. The player is holding, stopping, pushing or touching the other player in a wrong manner.

### **PUNISHMENT**

- ☆ Considered a Personal Foul of the Player
- ☆ This foul is made when the player is not shooting and the game starts only after throw in.
- ☆ If a foul is considered while the player is scoring, the player will be given a free throw. If the score is made during the foul the score is counted.

#### **2. DOUBLE FOUL :**

When two opponent players foul at a player at one time or foul personally then it is considered a double foul.

### **PUNISHMENT :**

- ☆ Both players are supposed to have made a personal foul.
- ☆ No free throw is given to the team; the game starts only after throw in.

#### **3. TECHNICAL FOUL :**

When any player speaks foul language or he misbehaves with the officials. The player is teased by the opponent or obstructed while playing. Leaving the ground or changing his dress without the permission of referee or scorer- A technical foul is given in all such situations or cases.

### **PUNISHMENT :**

- ☆ A foul note is given against the player and the team.



- ☆ If there is any technical foul against the coach, it is not considered as a team foul.
- ☆ A free throw is given to the opposite team.

#### 4. **INTENTIONAL FOULS :**

By doing physical foul on the opposite team's player. If any player deliberately makes such a repeat, he is fired out from the match.

#### **PUNISHMENT :**

- ☆ A foul is noted against the player and the team.
- ☆ Two Free Throws are given to the opposing team.
- ☆ By giving the throw in to the opposite team.

#### 5. **MULTIPLE FOULS :**

Two or more players of the opposing team do foul at one time.

#### **PUNISHMENT :**

- ☆ By giving one free throw to opposite team.

#### 21. **FIVE FOULS OF PLAYERS :**

When a player makes five fouls, that player has to leave the court immediately after being informed by the authorities. The team has to take an alternate player within 30 seconds.

#### 22. **FOUR TEAM FOULS :**

Personal foul, technical foul, multiple foul, double foul, intentional foul, all are considered as team fouls.

#### **PUNISHMENT :**

- ☆ The opposing team gets 2 free throws on each foul.
- ☆ When the team fouls are complete in one half, the other team is given free throws instead of throw in, at the time of foul.

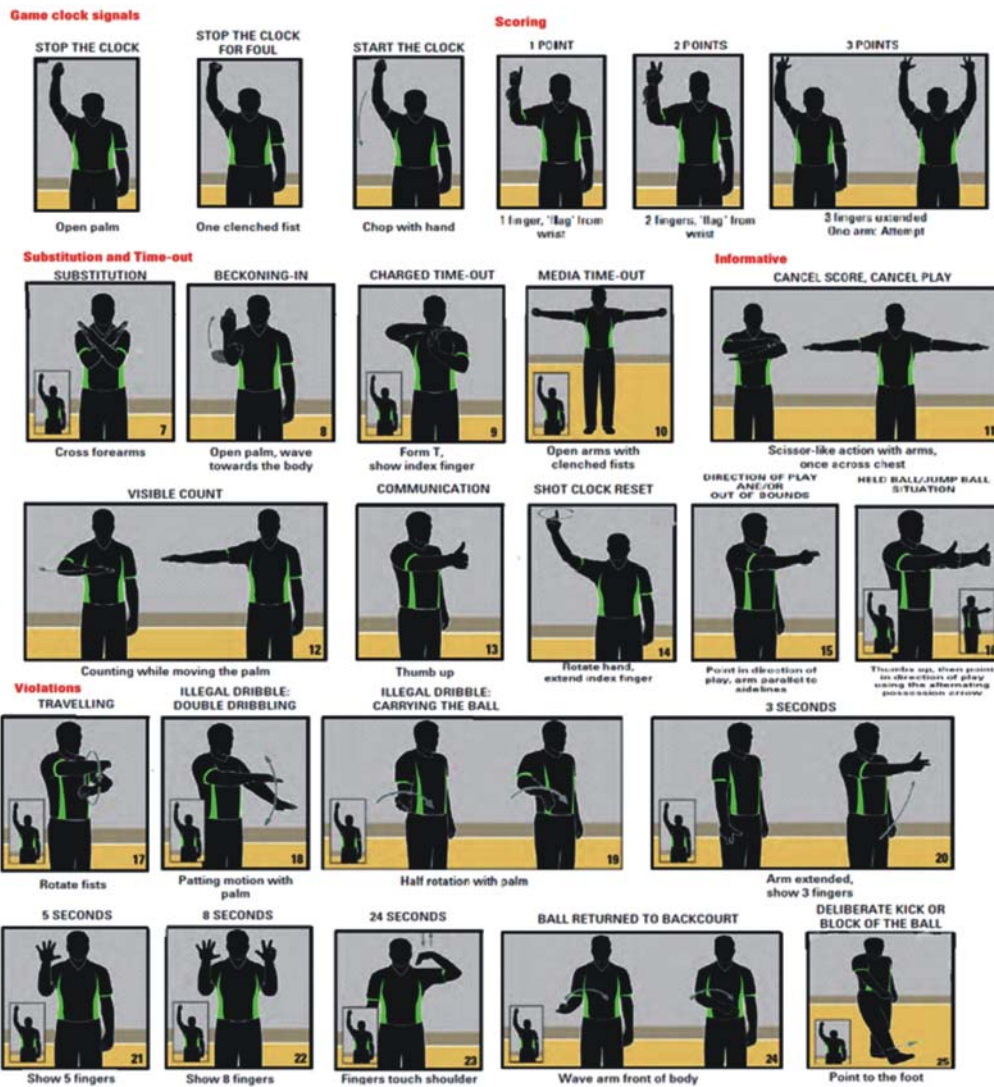

**Number of Players**

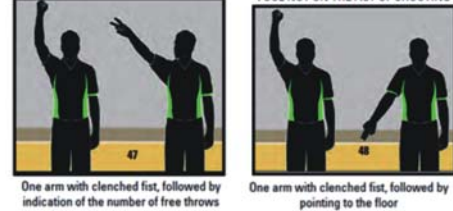
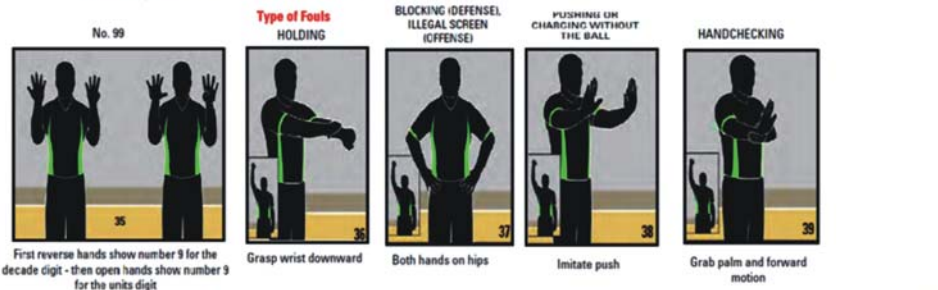
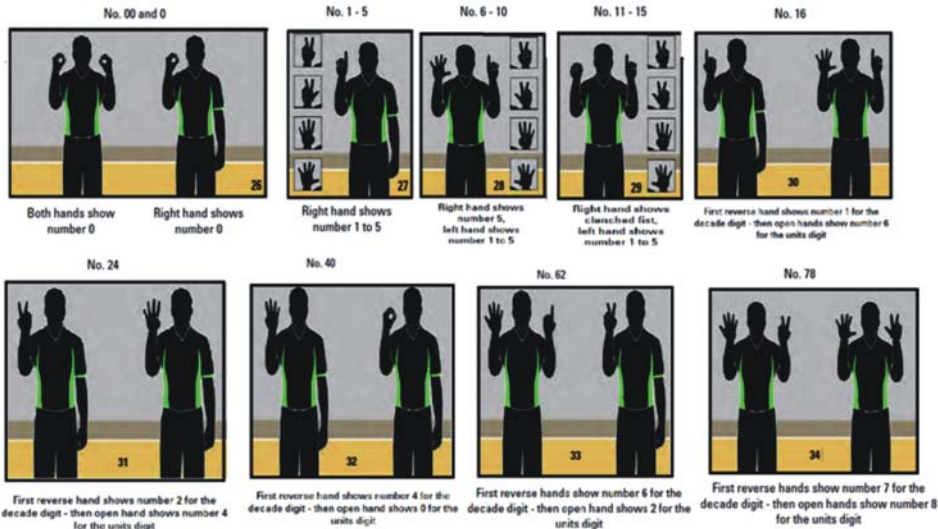

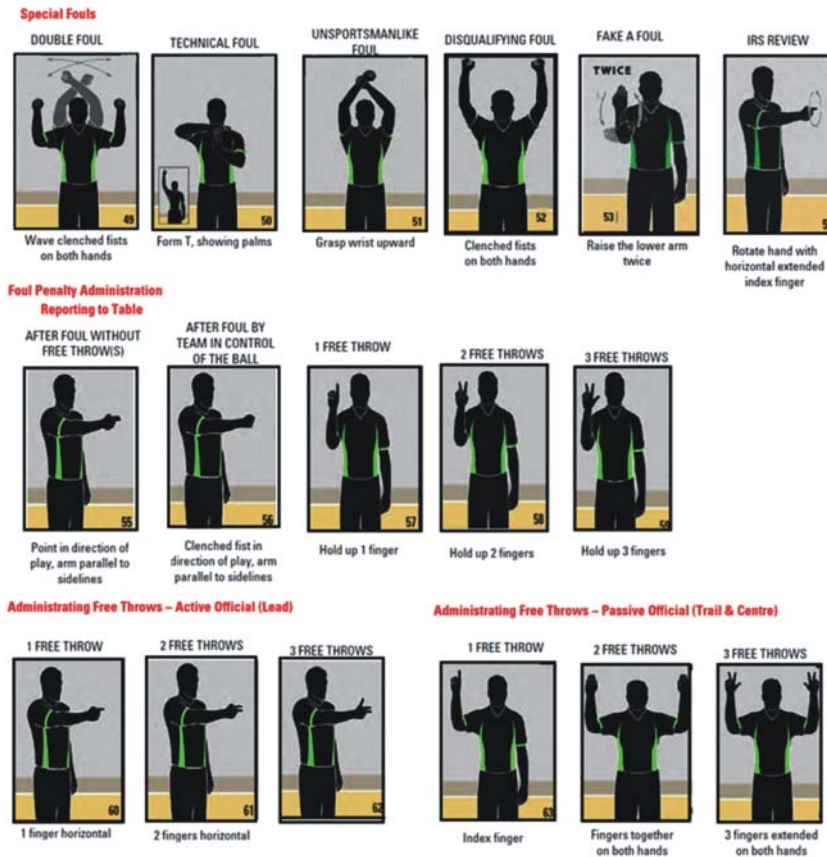

**Officials' signals**

**EXERCISE**

- 1) How much is the length of a Basketball court ?
- 2) How much is the breadth of a Basketball court ?
- 3) What are the number of substitute players in this game ?
- 4) What are the circumference of the ball for men ?
- 5) How many officials are there in a Basketball game ?
- 6) What is the time duration for a Basketball game ?
- 7) Give a brief account of any three fouls in a Basketball game ?

—0—

## LESSON - 11

# GYMNASTICS

### Things to Remember

History of Gymnastics has been known since ancient times. Chinese people started playing activities similar to gymnastics in 2600 B.C. Greeks and Roman had dominance in Gymnastics since the beginning. The word gymnastic is derived from the Greek Word 'Gymnastic' meaning to 'train naked' this word is used to describes that only male participants were allowed to take part in games. The women could not even see the games. The men used to take part in games naked without clothes only. All physical activities at that time were called gymnastics. That is why it is also called the mother of all games. As soon as the technical era developed many new games had taken shapes out of gymnastics e.g. Wrestling, Athletics etc. Gymnastics started developing itself in a new game.

### Gymnastic Apparatus for Boys.

1. Floor Exercises.
2. Pommel Horse.
3. Roman Rings.
4. Parallel Bars.
5. Horizontal bar.
6. Vaulting Table.



**Gymnastic Apparatus For girls.**

1. Floor Exercises.
2. Uneven Bar.
3. Balance Beam.
4. Vaulting Table.

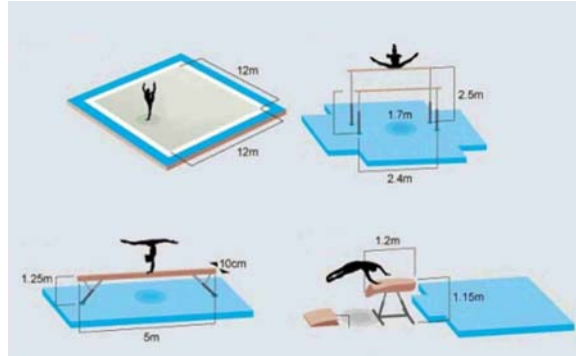

**Requirement of space and Dimensions of Apparatus for Gymnastic.**

**1. Vaulting Table**

This apparatus is same for Boys and Girls but height will be different.

Length	120 cms + 1 cm
Width	95 cms + 1 cm
Height for girls	125 cms + 1 cm
Height for boys	135 cms + 1 cm



**2. Uneven Bars**

Length of bars	240 cms
Length of the Upper bar	240 cms
Height of the lower bar	160 cms
Distance between the two bars	90 cms (minimum), 140 cms (maximum)



**3. Balanced Beam**

Length	500 cms
Height from ground/floor	120 cms
Diameter	5 cms
Width	10 cms (Middle)

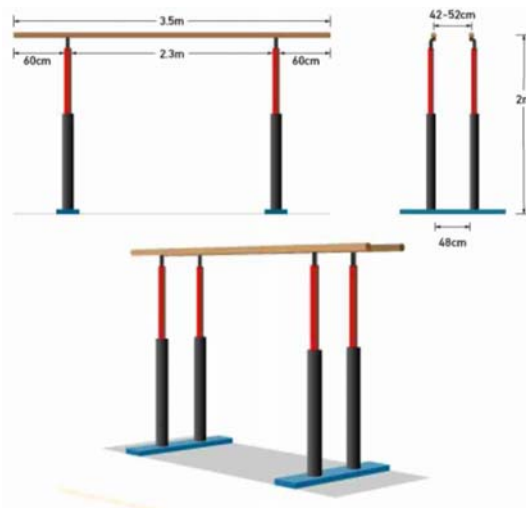

4. Floor Exercise

Length and breadth of the operating area	1200 cms × 1200 cms
--	---------------------

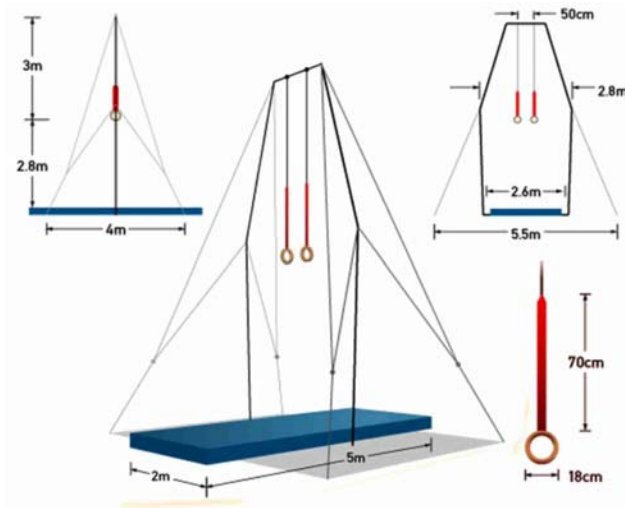

5. Parallel Bars

Length	350 cms
Height	175 cms
Distance between the two bars	42 cms to 53 cms

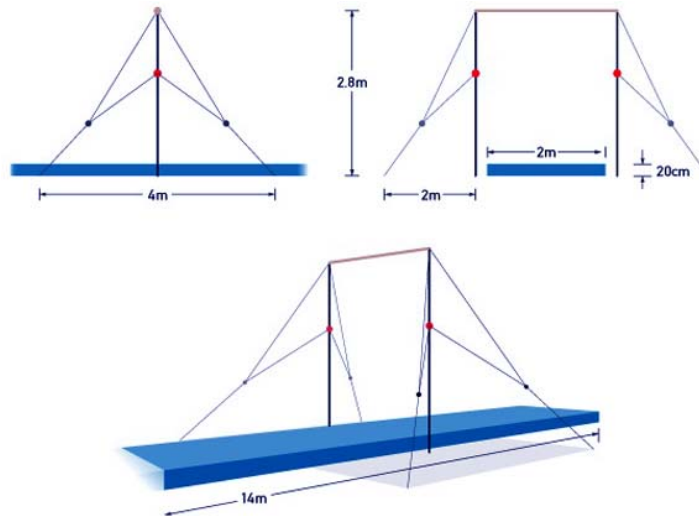



**6. Pommel Horse**

Length of the upper part	160 cms
Length of the lower part	155 cms
Width of the upper part	35 cms
Width of the lower part	30 cms



**7. Roman Rings**

Inner diameter of the ring	18 cms
Diameter of the profile	28 cms
Height of bar from the floor	575 cms

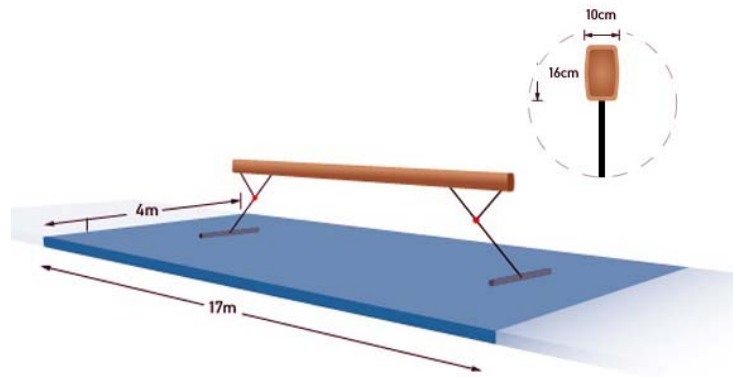
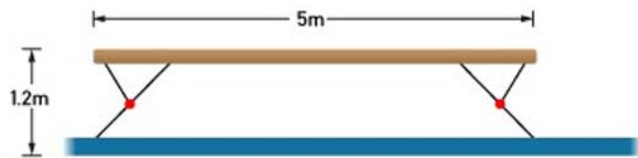

**8. Horizontal Bars**

Diameter of bar	28 m.m
Length	2400 m.m
Diameter of Pols	50-60 m.m
Diameter of Tension wire	5-6 m.m
Height of Bar	2550-2700 m.m

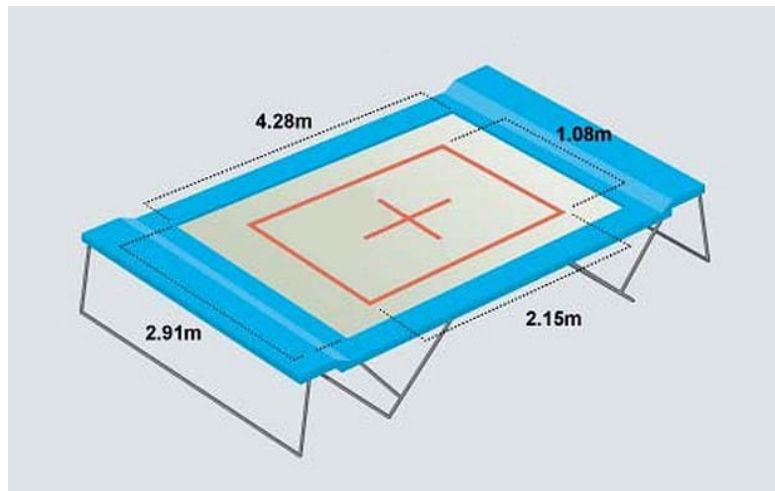

## MAIN SKILLS

### 1. PARALLEL BAR :

(1) Front Walk (2) Back Walk (3) Hand Stand (4) Kip  
(5) Basket Swing (6) Lay away to swing

### 2. VAULTING TABLE :

(1) Hand spring (2) Straddle Vault (3) Scott Vault (4) Through  
Vault (5) Split Vault

### 3. FLOOR EXERCISES :

(1) Front Roll (2) Back Roll (3) Cart Wheel (4) Back Flip  
(5) Round Off (6) Somersault (7) Cat Leap (8) Flick Flack  
(9) 360 Degree Turn

### 4. UNEVEN BAR :

(1) Up start (2) Split Up start (3) Grip Chaging (4) Flight aliment  
(5) Salt

### 5. BALANCE BAR :

(1) Front Roll (2) Back Roll (3) Cart Wheel (4) Back Flip  
(5) Back Somersault (6) Full turn on one leg (7) Jump with split  
leg (8) Front Somersault (9) Dismount.

**6. ROMAN RINGS :**

- (1) Swinging (2) Front Umpire (3) Hand Stand (4) Dislocation (5) Inlocation

**7. HORIZONTAL BARS :**

- (1) Front Joint Circle (2) Back Joint Circle

**8. POMMEL HORSE :**

- (1) Single Leg Circle (2) Double leg Circle (3) Front spindle (4) Back spindle (5) Side Travel

**SCORING**

In gymnastics scoring is a very difficult method in itself, which is as per the difficulty level of the performance of the gymnast. Its description is given in the Code of Points recognized by the Federation Intermate De Gymastics (FIG). In women’s competitions one senior judge and 15 other judges are appointed for scoring. The senior judge/ judges the score by keeping the highest and the lowest scores aside. In women’s competitions one senior judge and six other judges give the decision and the senior judge takes the average score of four judges and out of six judges he keeps the judges giving the highest score and those giving the lowest aside.

Three types of jury are made to do the scoring of the gymnastics performance :

- 1. Chief Jury.
- 2. Executive Jury.
- 3. Artistic Jury.

**1. Chief Jury :**

The function of this jury is to control the

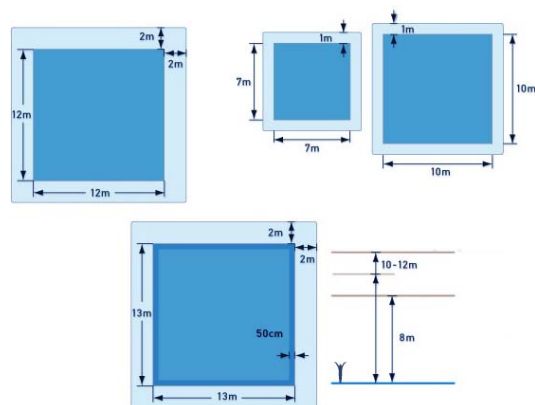

competition of the whole event, and to solve any dispute among the juries.

**2. Executive Jury :**

In this Jury there are four to six judges who keep a watch over the fouls made by a player. The other judges cut down the points of fouls made by the player. Then the points are cut and an average of sum of other points is calculated.

**3. Artistic Jury :**

In this, there is a panel of four to six judges, but they are supposed to give points to the whole performance of the player. An average of the sum of the scores that lie in between the highest and the lowest scores, is calculated.

**DRESS**

1. For boys it is mandatory to wear “Sando Baniyan” with Slax and gymnastics shoes. Girls are supposed to wear something through which body cannot be seen. A logo of country, state, college or school can be fixed on the left shoulder.
2. At the time of starting or finishing the competition, the gymnast is supposed to give his attendance by raising his hands.
3. No judges, gymnasts or their coaches can talk among themselves during a competition.
4. The decision of the judge is taken as final until or unless any objection is raised.

**EXERCISE**

- 1) When was Gymnastics for girls started in the Olympics ?
- 2) Which are the Gymnastics apparatus performed by girls ?
- 3) How much is the height of a Vaulting Table ?
- 4) How many judges are there for judgment in the boys competitions ?
- 5) How much is the length of a Parallel Bar ?

—0—

—(198)—

**LESSON - 12****GATKA****POINTS TO REMEMBER**

<b>S.NO.</b>	<b>DESCRIPTION</b>	<b>MEASUREMENTS</b>
<b>1.</b>	Shape of Gatka Field	Sphere
<b>2.</b>	Circumference of Gatka Field	Internal Diameter 30 feet External Diameter 34 feet
<b>3.</b>	Length of stick-	39 Inch
<b>4.</b>	Weight of stick-	About 500 gram
<b>5.</b>	Type of stick	Cane
<b>6.</b>	Thickness of stick	About 3/4 Inch
<b>7.</b>	Shape of Shield	About 9 Inch diameter
<b>8.</b>	Type of Shield	Made of cloth or leather and sloping round
<b>9.</b>	Time of Competition	3 minutes, 1.5 minutes + 1.5 minutes (interval 30 seconds)
<b>10.</b>	Game Officials	Referee council-4 members (1-inside the field as a head Refree, 3 outside the field as assistant Referees), 2- Scorers, 1-Time Keeper, 1- Judge.

The game of Gatka is about three centuries old. This game is blessed by sixth Guru Shri Guru Hargobind Singh ji and tenth Guru Shri Guru Gobind Singh ji. Initially, this game was exhibited in religious processions and social gatherings only. But after the establishment of Gatka Federation of India and Gatka Federation of Punjab in 2008, Gatka is being played according to proper rules. This has been recognized as a Game. Today, it has also been included in the calendars of games of schools, colleges and universities.

### **COMPETITIONS OF GATKA :**

**Competitions of Gatka are held as under :**

<b>Competitions-</b>		<b>Number of players</b>
1. Free Stick Team Event	–	3 + 1 = 4 players
2. Free Individual Event	–	1 player
3. Single Stick Team Event	–	3 + 1 = 4 players
4. Single Stick Individual Event	–	1 player

### **AGE GROUP :**

Under-17, Under-19, Under-25

### **FOULS :**

1. Double attack, to blow the stick forcefully, to push the player, falling of stick or the shield, to hit the player intentionally.
2. Institution for promoting Gatka and making rules for it :- Punjab Gatka Association, Gatka Federation of India, World Gatka Federation.

## **GROUND FOR GATKA COMPETITION :**

**The field is divided into three categories :**

- 1. Arena.**
- 2. External field of arena.**
- 3. Reserved area.**

### **1. ARENA :**

A certain place where competitions of Gatka are held is called arena. Its circumference is about 30 feet. This region is made of grass, soil, wood or some other material. The breadth of the lines of this region is 5 centimetres, if this field is an indoor field, then the height of the roof should be minimum 15 feet. It should be taken care of that the Gatka ground should not be slippery.

### **2. EXTERNAL FIELD :**

The area around the arena is called the external field. Its breadth is 4 feet.

### **3. RESERVED AREA :**

The place outside the external field is called the Reserved Area.

## **GENERAL RULES FOR PLAYING GATKA**

**There are two types of Gatka competitions :-**

- 1. Free Stick**
- 2. Single stick.**

In a single stick competition, the player has a single stick and a shield. The player tries to touch the body of the opposite player by attacking (on) him with his stick and the opponent player defends himself against his attack with his shield. If the stick touches the body of the opponent successfully, then the player with the stick gains a point. In a single stick competition both attack and defense are done with the

help of a stick. The player gains two points when he blows the stick above the waist and one point for blowing the stick below the waist up to feet. He gains three points for blowing the stick on the opponent's back.

### ਗਤਕਾ ਗਰਾਊਂਡ

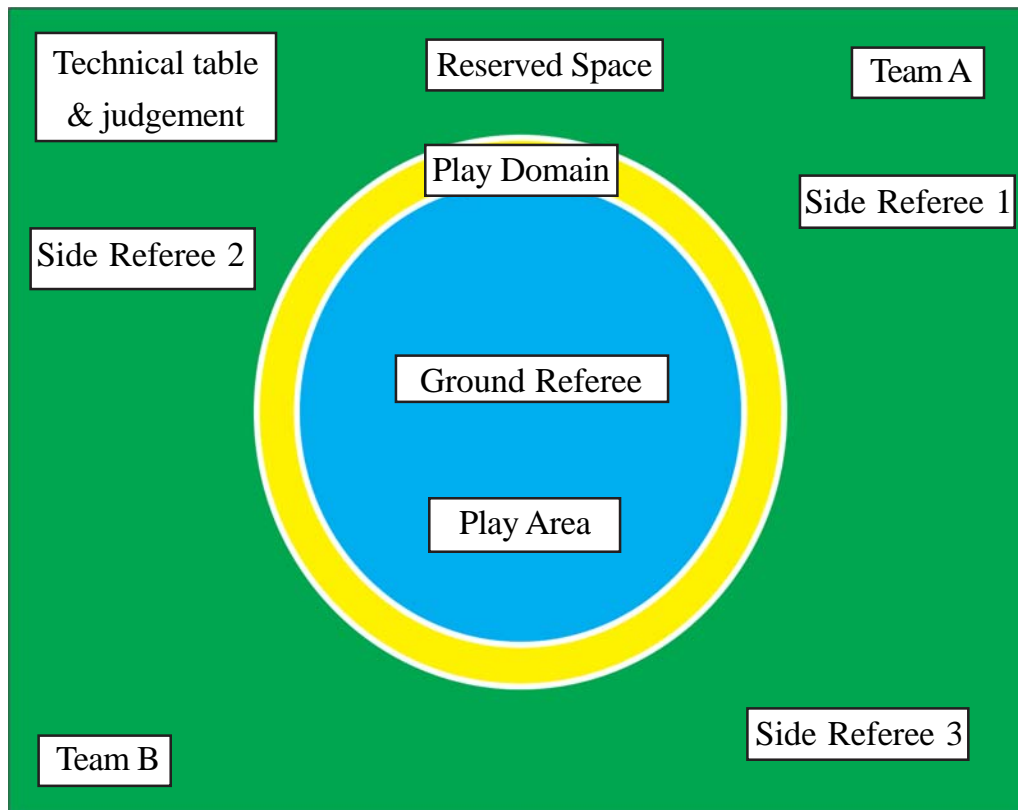

### EXERCISE

- 1) Which age groups /categories are there in Gatka Game ?
- 2) How many players are there in total in a Single-Stick team event ?
- 3) How many parts is the Ground ?
- 4) What is meant by the Outer area ?
- 5) Mention the name of the Sikh Guru by whom this Game has been blessed ?

—0—

—(202)—