

BASIC SCIENCE

Part - 1

Standard VIII



Government of Kerala
Department of Education

State Council of Educational Research and Training (SCERT), KERALA
2015

The National Anthem

Jana-gana-mana adhinayaka, jaya he
Bharatha-bhagya-vidhata.
Punjab-Sindh-Gujarat-Maratha
Dravida-Utkala-Banga
Vindhya-Himachala-Yamuna-Ganga
Uchchala-Jaladhi-taranga
Tava subha name jage,
Tava subha asisa mage,
Gahe tava jaya gatha.
Jana-gana-mangala-dayaka jaya he
Bharatha-bhagya-vidhata.
Jaya he, jaya he, jaya he,
Jaya jaya jaya, jaya he!

PLEDGE

India is my country. All Indians are my brothers and sisters.

I love my country, and I am proud of its rich and varied heritage. I shall always strive to be worthy of it.

I shall give respect to my parents, teachers and all elders and treat everyone with courtesy.

I pledge my devotion to my country and my people. In their well-being and prosperity alone lies my happiness.

State Council of Educational Research and Training (SCERT)

Poojappura, Thiruvananthapuram 695012, Kerala

Website : www.scertkerala.gov.in, e-mail : scertkerala@gmail.com

Phone : 0471 - 2341883, Fax : 0471 - 2341869

Typesetting and Layout : SCERT

Printed at : KBPS, Kakkanad, Kochi - 30

© Department of Education, Government of Kerala

Dear students,

You were provided with opportunities to observe your surroundings and engage in simple experiments and investigative activities in earlier classes. The classroom experience, undoubtedly, might have helped you to record the information systematically and assimilate ideas through discussion and analysis. While understanding the scientific approach, there should also be the attitude to take forward the skills to apply them in day-to-day life. Moreover, an eco-friendly perspective must be adopted too. All these, through direct experiences, enquiry and understanding preferably.

This textbook presents ideas in accordance with this. There are experiments, illustrations and explanatory details that enable the comprehension of these ideas. There are opportunities appropriate to the situation to make learning more enjoyable.

Go ahead, thinking, asking questions, approaching ideas critically and quizzing with teachers and friends.

Make learning a joyful experience.

Regards,

Dr. S. Raveendran Nair

Director, SCERT

TEXTBOOK DEVELOPMENT TEAM**Emerson F**

GGHS, Chavara, Kollam

Satheesh R

GHSS Anchal West, Kollam

Shajil U K

GGHSS, Balussery, Kozhikode

Nisar Ahamed M

GHSS Venjarammood, Trivandrum

Rasheed Odakkal

GVHSS Kondotti, Malappuram

Vineesh T V

GHS Chenad, Wayanad

PD Baby

St. Antony's HSS, Mutholi, Pala

Gopalan N K

HSA(Rtd.), KKMGGVHSS Vadakara

Unnikrishnan T I

Headmaster (Rtd.), AKKRHS for Boys, Kozhikode

Pradeepkumar K V

Moothedath HSS, Taliparamba, Kannur

Premachandran K V

GHSS Maniyoor, Vadakara, Kozhikode

Sajikumar K G

GV & HSS for Girls, Manacaud, Trivandrum

Sureshkumar K

AMHSS, Thirumala, Trivandrum

Babu Payyath

BPO, BRC, Kozhikode

Muhammed Abdul Nazar

Master Trainer, IT @ School

Santhoshkumar V G

BYKVHSS, Valavanoor, Malappuram

Dr. Vishnu V S

Asst. Prof., College of Engineering, Trivandrum

Sadanandan C

Pantheerankave HSS, Kozhikode

Muhammed Rafi C

Govt. Technical HS, Naruvambram, Kannur

Shabu Ismail

PMSAVHSS Chappanangadi, Malappuram

KT Manoj

CBHSS Vallikkunnu, Malappuram

Hassan C C

MMVHSS Parappil, Kozhikode

Preethi KA

SHS Mannarkadu, Palakkad

EXPERTS**Prof. Sivasankara Pillai**Head (Rtd.), Dept. of Physics,
Women's College, Trivandrum**Dr. S Mohanan**Reader & Head (Rtd.), Dept. of Physics,
University College, Trivandrum**Paul P I**Associate Prof., Dept. of Zoology, Mar Ivanios
College, Trivandrum**Dr. Alaudeen M**

Principal (Rtd.) Govt. College, Elerithattu

Sebastian Lukose T JSel. Grade Lecturer (Rtd.), University College,
Trivandrum**Dr. N Ratheesh**

Asst. Professor, SN College, Kollam

ENGLISH VERSION**Dr. Sushil Kumar R**Associate Professor of English, D B College,
Sasthamcotta**Dr. Saji Mathew**Asst. Professor, School of Letters,
M G University**Famila E R**

HSST, GHSS, Karunagappally

K Suresh Kumar

AMHSS, Thirumala, Trivandrum

ARTISTS**Musthajib E C**

MMETHS, Melmuri

Noushad Vellalasseri

Ganapath AUPS, Keezhisseri

Muhammed Shameem

VAUPS, Kavanoor

Lohithakshan K

Assisi School for the Deaf, Malapparambu

Viswanathan P

DDE Office, Malappuram

Academic Co-ordinator**Dr. Ancy Varughese**

Research Officer, SCERT

Contents

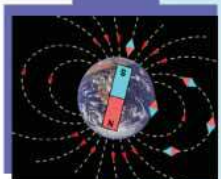
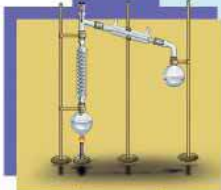

1. Life's Mysteries in Little Chambers 07
2. Cell Clusters 22
3. Let's Regain our Fields 35
4. Properties of Matter 53
5. Basic Constituents of Matter 68
6. Chemical Changes 80
7. Metals 91
8. Measurements and units .. 103
9. Motion 117
10. Force 132
11. Magnetism 145

Certain icons are used in this
textbook for convenience



*For further reading
(Evaluation not required)*



*ICT possibilities for making
concepts clear*



Significant learning outcomes



Let us assess



Extended activities

Unit
1

Life's Mysteries in Little Chambers

The bell rang.. It is the Biology period now.

*Manu, the class leader, peeped out to the verandah and said,
"Teacher is coming. She has something in her hand too".*

It is her usual way. She always carries some materials in her hand. What is she bringing today? Everyone became anxious.

When the teacher entered the class, Rahma said in a loud voice,

*"I know it. Isn't it a microscope?
And what is in your other hand, Madam?"*

"I'll tell you....."

The teacher placed the microscope on the table and gave the other materials to Meenu.

"Madam, isn't it the root of a plantain?"

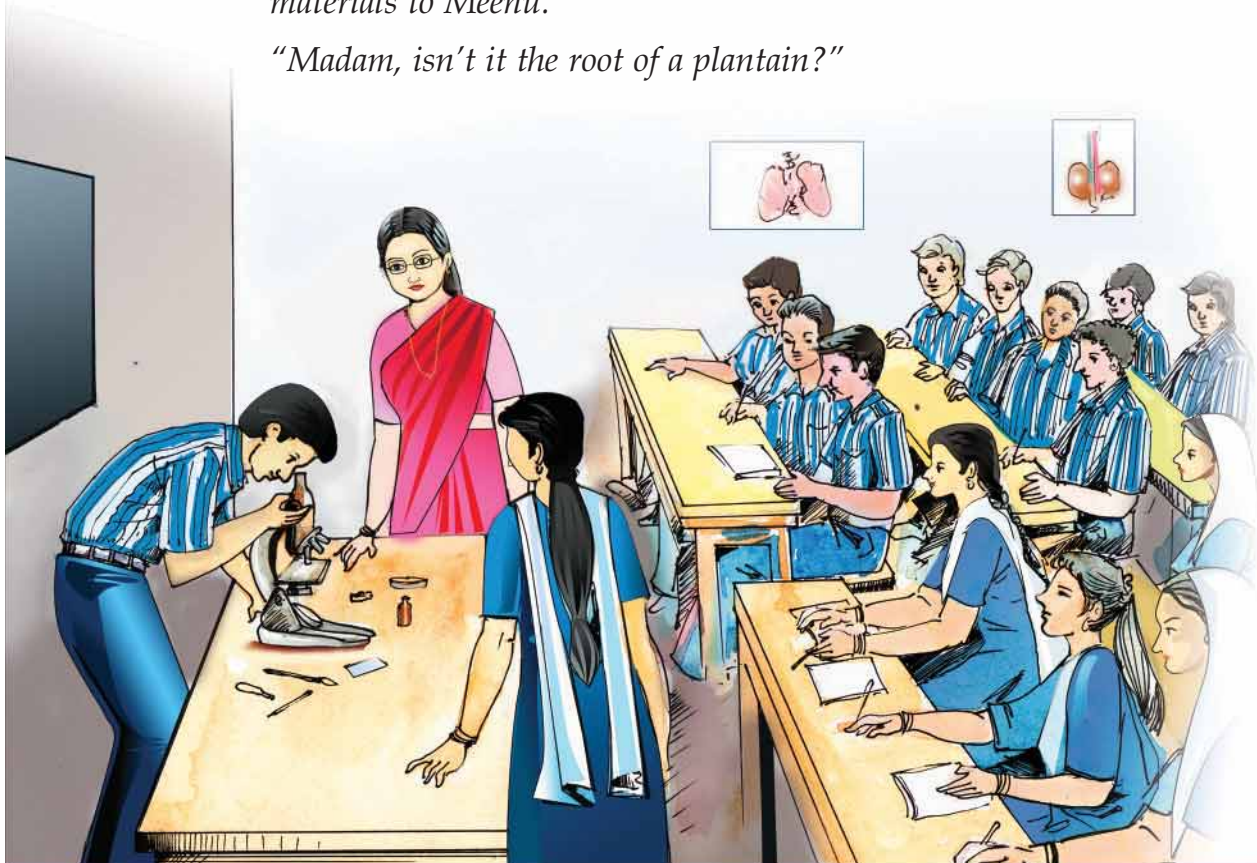

“Well, don’t you know that the body of all organisms are made up of cells? Let’s observe the cells in the root of plantain through this microscope. Don’t you remember having observed onion cells? Similarly arrangements should be made to observe the cells in the root of plantain. All required materials are there in this box. Who will do this?”

“I’ll do Madam”, Manu came forward enthusiastically.

He took the section of the root using a blade, placed it on a slide and observed it through the microscope...

Nothing could be seen! Then he turned the knob of the microscope. Feeling disappointed he said,

“No Teacher. Nothing is visible”.

Why were Manu’s attempts a failure? Can you help him? For this, you must know how to operate a microscope and prepare materials for observation.

Let’s familiarise ourselves with the microscope. Observe the microscope with the help of your teacher and identify the following parts and their use.

- Eyepiece
- Knob
- Objective lens
- Stage and clip
- Condenser
- Mirror

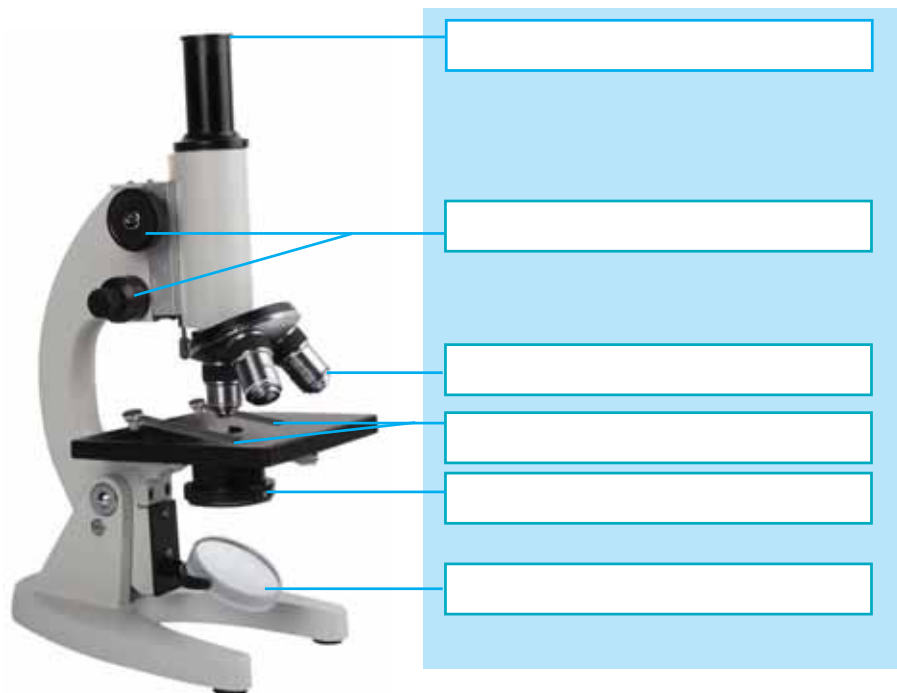

Fig. 1.1
Compound microscope

The function of a microscope is to magnify objects, isn't it? Lenses are fixed in the microscope for this purpose. Name the parts where lenses are fixed.

-
-

Microscopes in which more than one lens is used are called compound microscopes (Fig 1.1).

Analyse the given description on the basis of indicators and note down your inferences in the science diary.

Arrangement of light in a microscope

In the microscope, the part fixed below the stage is to reflect light on the material to be observed. This arrangement which is fixed in a metal ring has two planes, a plane mirror to reflect sunlight and a concave mirror to reflect artificial light. The lens in the condenser that is fixed on the lower side of the stage focuses light on the material to be observed. Diaphragm, a part of the condenser, helps to regulate the intensity of light.

Indicators

- Why is a mirror fixed in a microscope?
- Why do we use a slide made of glass to place the material to be observed?

Have you understood the basic concepts of a microscope? Accuracy in using a microscope can be attained only through practice. Learn to operate a microscope using the permanent slides available in your science lab.

Let's prepare the observation material

Preparation of observation material requires much accuracy and patience. Observe the illustration that shows the stages for the preparation of the slide to observe plant cells. Then prepare a slide by taking the cross section of the root of plantain.



Magnification power



The magnification power of objective lenses are marked as 10x and 45x. Such markings can be seen in eyepiece too. The magnification power of a microscope is the result of multiplying the numbers seen in the objective lens and the eyepiece.

Preparation of observation material







 Stage 1 Put the material to be observed in the petridish containing water to prevent dehydration.	 Stage 2 Take thin cross sections of the material to be observed.	 Stage 3 With a brush, shift the sections to a watch glass containing water.	 Stage 4 Put the thinnest and complete sections to a watch glass containing stain.
 Stage 5 Add one or two drops of glycerin to the slide to prevent drying up of the material.	 Stage 6 Wash the stained section in clean water and place it in the glycerin on the slide.	 Stage 7 Place a cover glass over the material using a needle in such a way that air bubbles do not pass.	 Stage 8 Wipe out the excess glycerin using tissue paper.

Illustration 1.1

Observe the slide you have prepared through a microscope. Try to understand the difference in the magnification when lenses 10x and 45x are used.

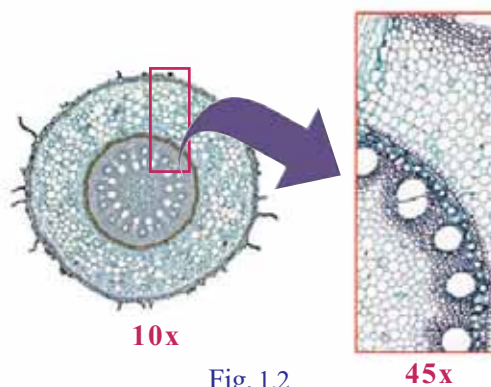

Fig. 1.2

Sample of practical recording	
Aim	:
Materials required	:
Procedure	:
Observation	:
Inference	:

Recording the findings is as important as conducting practicals in science. Record each stage of the experiment following the sample given, in your science diary.

Discovering the cell

Robert Hooke was the first scientist who observed cells with the help of a simple microscope. He observed the section of cork through a microscope and called the tiny chambers seen in the section 'cell.'

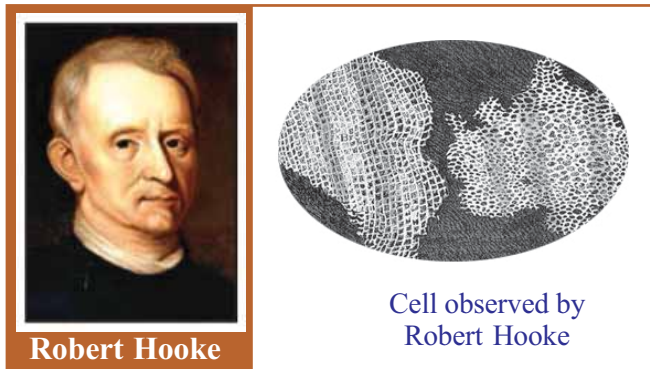
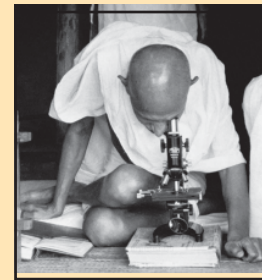

Fig. 1.3

Study of the cell is an extensive branch of science which is rapidly developing nowadays. It is known as Cell Biology. Remarkable findings that paved way for the development of cell biology were made in the middle of nineteenth century.



Science for Survival



Gandhiji observing pathogens through a microscope (Sevagram Ashram – 1940)

It was the invention of microscopes that enabled us to observe and study microscopic pathogens. This brought about drastic changes in the field of medicine. Such instruments enabled us to overcome the limitations of vision and bring the diseases that the world dreaded, under control.

◀◀ Milestones in the history of Cell Biology ▶▶▶

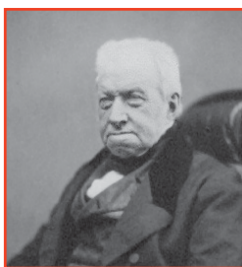

Robert Brown
Discovered the centre of the cell, and named it the nucleus.

1831

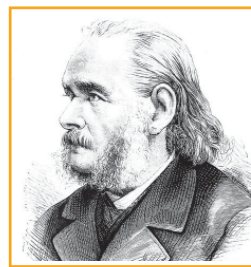

M.J. Schleiden
Found out that the body of a plant is made up of cells.

1838



Theodor Schwann
Found out that the body of an animal is made up of cells.

1839



Rudolf Virchow
Observed dividing cells and inferred that new cells arise only from existing cells.

1858

Cell Theory

The cell theory was formulated by M.J.Schleiden and Theodor Schwann summarizing the findings of various scientists. It puts forward two main concepts -

1. The body of all organisms is made up of cells.
2. Cells are the structural and functional units of organisms.

What are the functions performed by cells?
Observe the illustration.

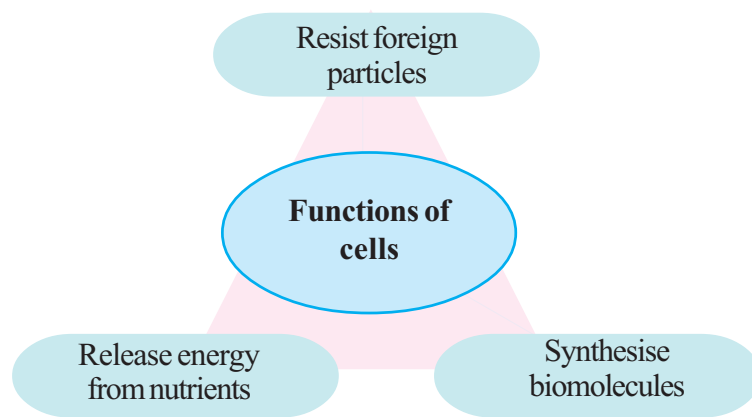

The structure of a cell is complex enough to perform all these functions. There are specific parts to perform each physiological function inside the cell.

Observe different parts of a plant cell.

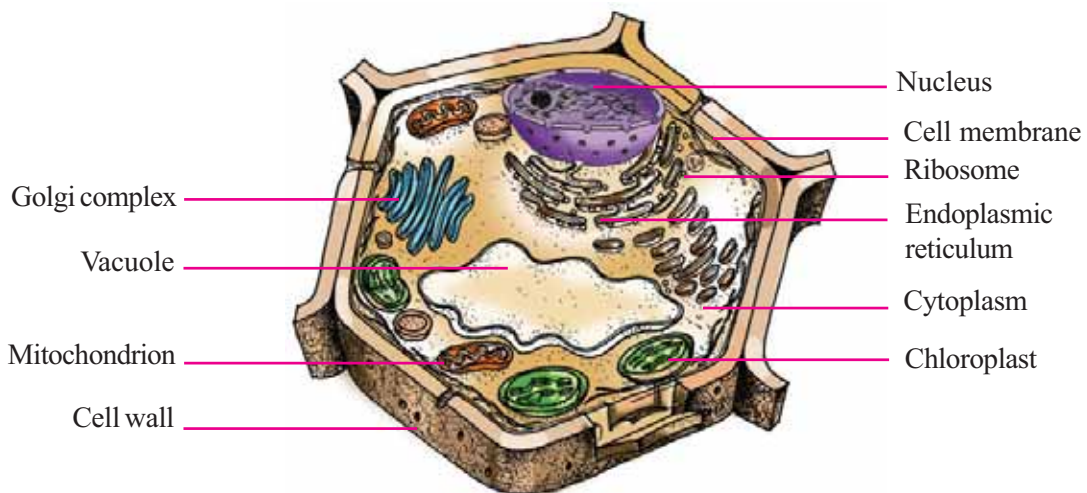
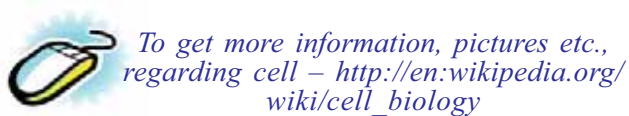

Fig. 1.4
Plant cell

You are already familiar with the cell wall, the cell membrane (plasma membrane), the cytoplasm, the nucleus etc. What are the other parts you observed in the figure? List them.

-
-
-
-
-
-



Read the following information to know more about each cell organelle.

Protoplasm and cytoplasm

All substances inside the cell membrane constitute the protoplasm. Cytoplasm is the part of the protoplasm excluding the nucleus. All factors required for life activities are present in the cytoplasm. Cell organelles are the specific parts seen in the cytoplasm to perform physiological functions.

Mitochondrion



- Power house of the cell. Helps in the production and storage of energy.
- Abundantly seen in the cells of liver, brain and muscles where energy requirement is high.

Endoplasmic reticulum



- The passage in the cell. Conduction of materials inside the cell takes place through this organelle.
- Also known as cytoskeleton as it provides firmness and shape to the cell.

Ribosome

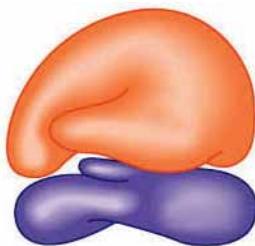

- Centre of protein synthesis in the cell.
- Seen either attached to the endoplasmic reticulum or free in the cytoplasm.

Vacuole

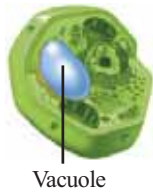

- Covered by a characteristic membrane called tonoplast.
- Stores water, salts, excretory materials etc.

Golgi complex



- Collects cell secretions like enzymes, hormones, mucous etc., in small vesicles.
- Seen in plenty in glandular cells.

Complete the illustration given below related to different kinds of organelles.

Vacuole			
<ul style="list-style-type: none"> • • 			
<ul style="list-style-type: none"> • • 			
	Endoplasmic reticulum		
<ul style="list-style-type: none"> • Power house. • Seen in plenty in the liver, brain, muscles etc. 	<ul style="list-style-type: none"> • • 	<ul style="list-style-type: none"> • • 	

Illustration 1.2

Stages of development

The development of cell biology is the result of the growth in the field of research of microscopes. A compound microscope magnifies an object only 2000 times (maximum) its size. Electron microscopes utilize electrons instead of a light source (Fig 1.6). With the emergence of the electron microscope, which magnifies objects million times clearly we got a thorough understanding of microscopic cell organelles.



Fig. 1.5
A microscope of the earlier times



Fig. 1.6
Electron microscope

The history of the microscope is the best evidence showing how science enables the development of technology and how technology enables the development of science. It would be very interesting to collect information and pictures of various microscopes from the simple microscope that helped Robert Hooke to observe tiny chambers of life to the advanced microscope that enabled us to understand the secrets of life within those tiny chambers. Organise an exhibition including all the collections.

Nucleus – the regulatory centre of the cell

Isn't it necessary to control and coordinate innumerable life activities in the cells? The various proteins produced in the cell play a major role in regulating various activities in the cell. The synthesis of proteins is under the control of genes in the chromatin reticulum in the nucleus. Hence the nucleus is considered as the regulatory centre of the cell.

Observe the illustration 1.3.

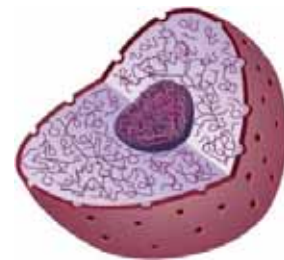

Fig. 1.7
Nucleus

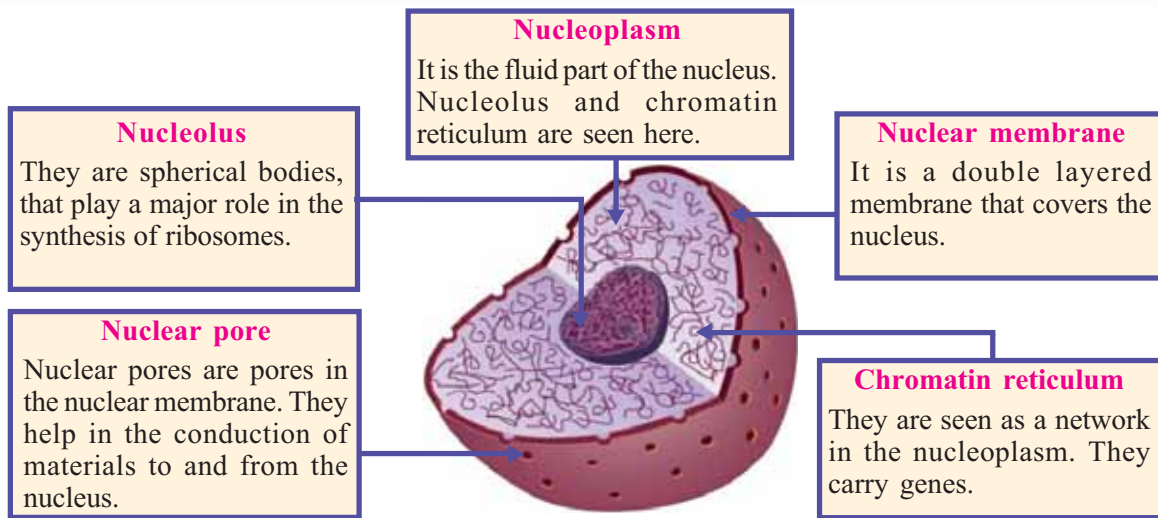

Illustration 1.3

Have you understood the different parts of the nucleus and their functions? Now complete the table given below.

Part					
Peculiarity					

Table 1.1

Prokaryotes and eukaryotes

In the cells of bacteria, cyano bacteria and mycoplasma, no nucleus is seen. These organisms are called prokaryotes.

But in the cells of amoeba, animals and plants, a well defined nucleus covered by membrane is seen. These organisms are called eukaryotes.

Isn't it surprising that cells exist even without a nucleus?

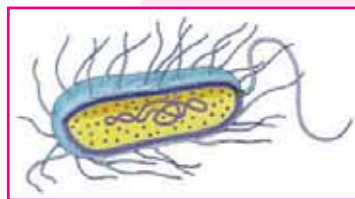
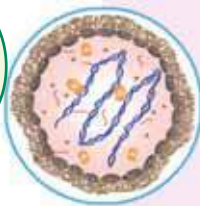

Those who change colour and taste



The colour and taste of fruits change when they ripen. What may be the reason for this ?



Haven't you had such doubts? Can you guess the reason?

Read the description below and check the validity of your guess. Discuss on the basis of indicators and record your inferences in the science diary.

Plastids are the cell organelles that are exclusively found in plant cells. They are of three kinds namely chromoplast, chloroplast and leucoplast. You know that photosynthesis is performed by chloroplast. Chromoplasts impart colour to flowers and fruits. Xanthophyll (yellow), carotene (yellowish orange), anthocyanin (red, purple) etc., are certain pigments in the chromoplasts. Various ranges of these pigments impart different colours to various parts of the plant. Leucoplasts are plastids having no specific colour. Leucoplasts are seen in plenty in the cells where food materials are stored. As fruits ripen, chloroplasts change to chromoplasts. Starch is converted to sugar. This is the secret behind the change in the colour and taste of fruits.



Biomembranes

Didn't we see that the cell has a membranous covering. This covering separates the cell from its adjacent cells. Not only the cell, but the nucleus and many of the cell organelles also have membranous covering. These biomembranes regulate the exchange of materials between cells and between cell organelles and cytoplasm. These membranes are called selectively permeable membranes as they allow only the essential materials to pass.

Indicators

- *Plastids in the plant cells.*
- *Pigments in the chromoplasts.*
- *Chromoplasts and sunlight.*
- *Change of colour and taste in fruits.*



Haven't you now learnt about cell organelles that perform different physiological functions in a plant cell? Observe the illustration showing various cell organelles in the animal cell.

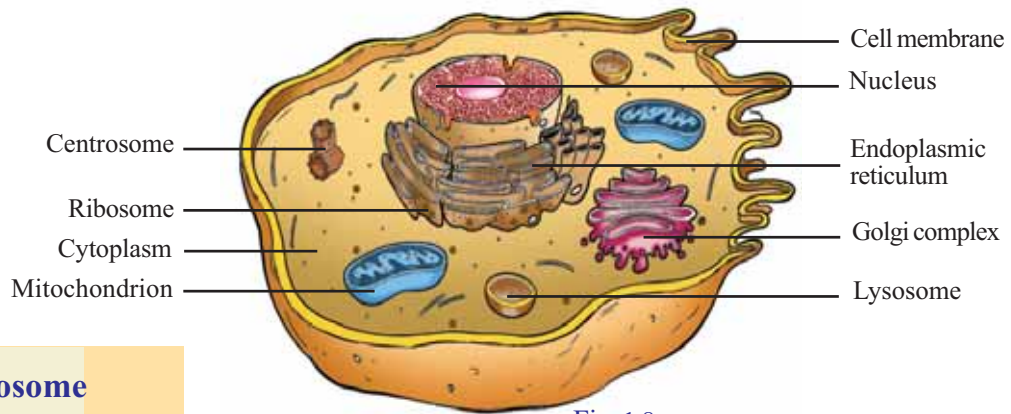

Fig. 1.8
Animal cell

Centrosome

Centrosome is the cell organelle that is found only in animal cells. The centrioles that play a major role in cell division are seen in the centrosome.

Lysosome

Lysosome contains the digestive enzymes that are required for the destruction of foreign substances entering the cell. It is seen in animal cells.

Compare the plant cell and the animal cell and complete the illustration given below.

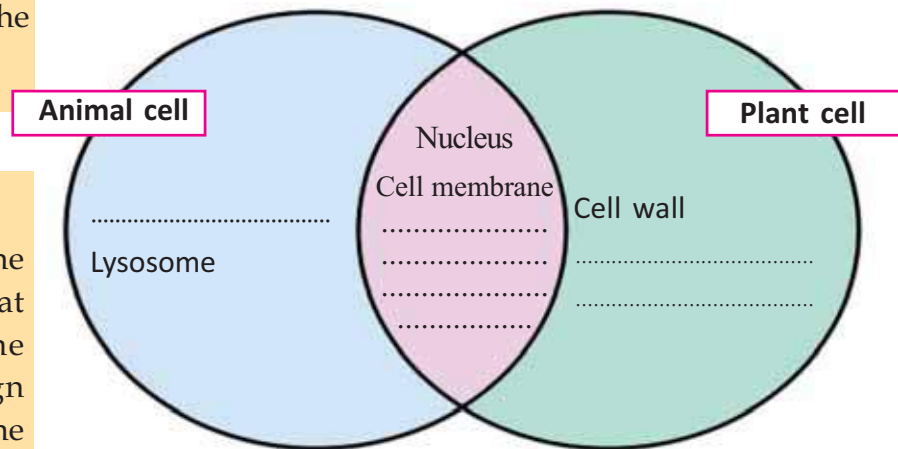

Illustration 1.4

Prepare an illustration like this showing the differences between prokaryotes and eukaryotes. Though organisms show diversity in their external characters, their cells show resemblances in their structure and function. This unity at the micro level is a clear evidence of the interrelationship of organisms.



Significant learning outcomes

The learner can

- identify and explain cell as the fundamental unit of life.
- explain the milestones in the history of cell biology.
- compare different cell organelles and their functions and explain their similarities and differences.
- compare plant cell and animal cell and find out their similarities and differences.
- take sections of plant parts and prepare slides.
- handle microscopes accurately and precisely.



Let us assess

1. Complete the concept map related to the structure of animal cells.

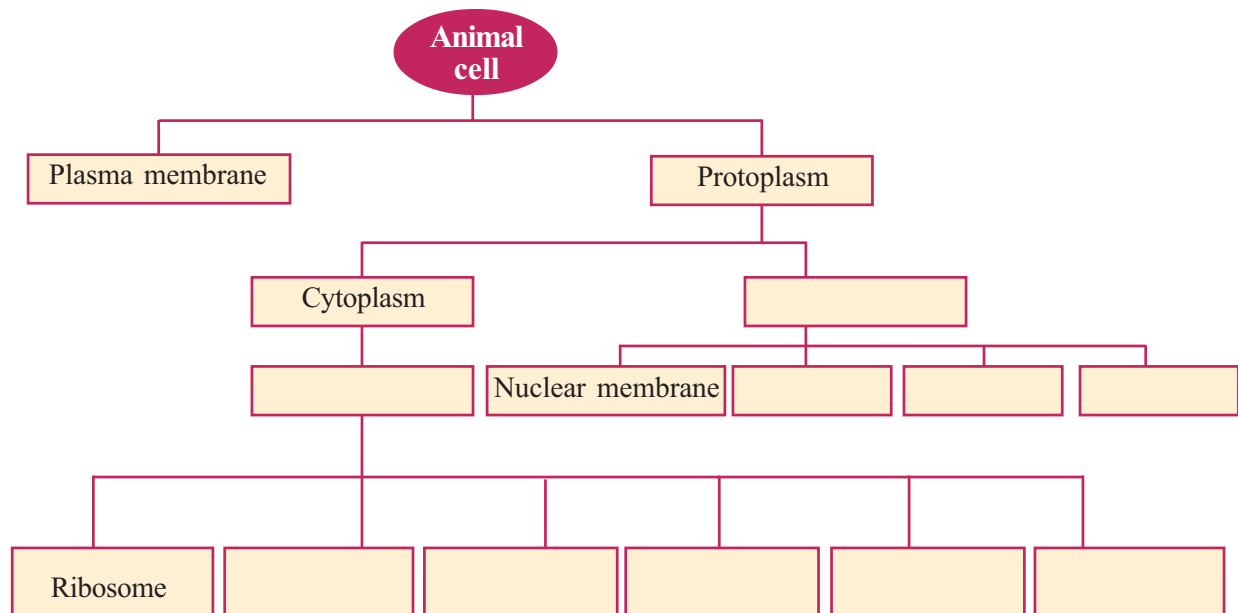

2. (i) Identify the parts A,B, C,D,E marked in the plant cell.

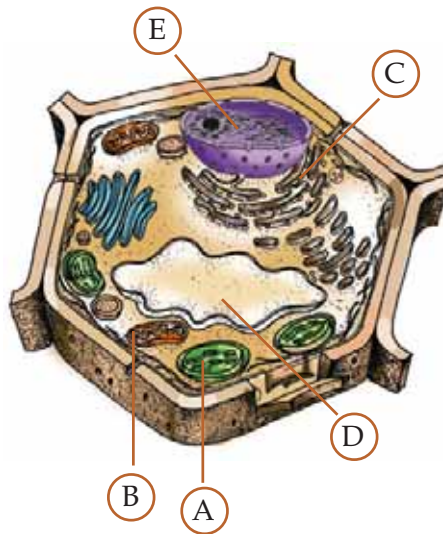

(ii) Write the function of the parts denoted by the letters given below.

A	
B	
C	

(iii) In which part of the cell are genes found?



Extended activities

1. Cell cake

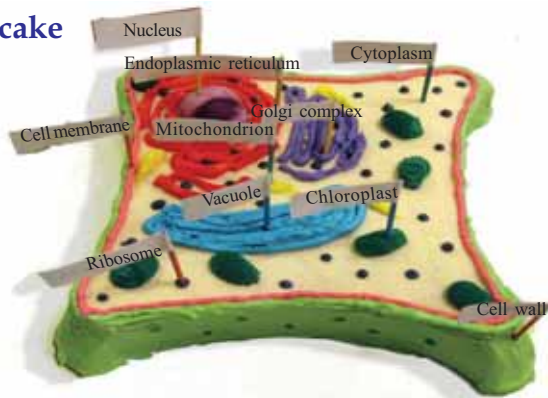

This is the cell cake. Shall we prepare a wonderful cake like this?

What are the materials used? Discuss.

Cereals, vegetables, woollen threads, beads.....

Construct the model of a cell with your friends and exhibit it in the classroom.

2. Anu's poem



*Many are my shapes, and
Many are my sizes.
Many are those made of me,
the grass and worm, and your
body too!
Many are the tasks I undertake,
Into many I multiply and grow.
Not visible to the naked eye
though
I am, I am the basis of life!
In all and there am I.
Now tell me, who am I?*

Could you answer Anu's question?

If yes, recite the poem with your friends rhythmically.

Can't you write a story, a poem or a cartoon based on the topic 'Cell'?

Prepare a magazine including the creative works of your friends.



Unit
2

Cell Clusters

*All organs are made up of cells.
But how different are the eyes, nose and tongue !*



Did you notice Unnikuttan's doubt?
What is your opinion?

.....
Are the same type of cells seen in all parts of the body?
Analyse the illustration and description given below and
write down the inferences in your science diary.

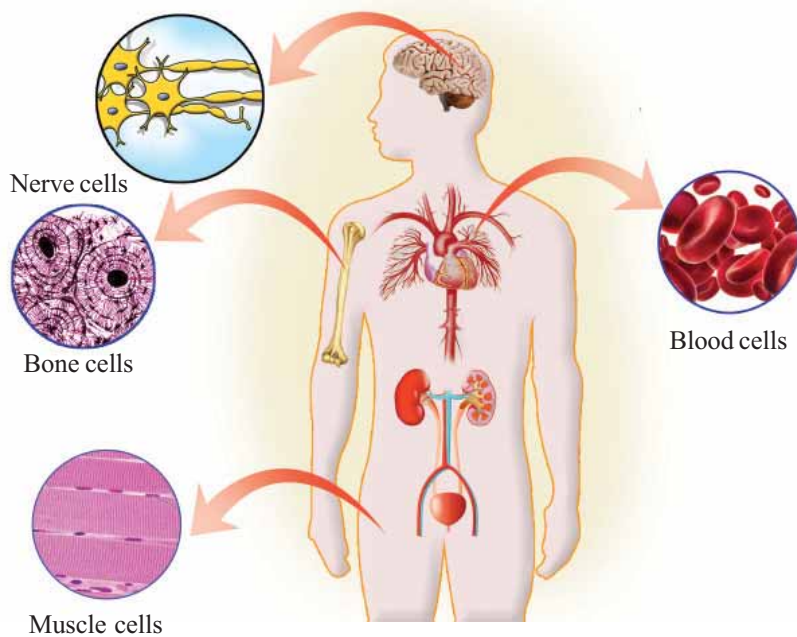

Illustration 2.1

Diversity among cells

Each part of the human body is made up of millions of different kinds of cells. There are about 200 different kinds of cells like nerve cells, muscle cells, blood cells, bone cells etc., in the human body.

*What a wonder our body is!
How do millions of such cells
function effectively without
getting messed up?*



Yes, the human body is indeed a wonder. The well-being of the human body depends on the systematic and regulated action of the cells. Similar cells function together in groups, not separately. Such clusters of cells are called tissues.

Tissues

Tissues are groups of similar cells that have a common origin and perform specific functions. There are different kinds of tissues in multicellular organisms like plants and animals. The coordinated action of these tissues helps in performing different physiological functions effectively.

Have you observed the muscle cell and nerve cell in Illustration 2.1? Though both are cells, they differ so much in appearance.

What may be the reason for the differences?

How do these differences influence the physiological functions?

Conduct a discussion on the description given below on the basis of the indicators.

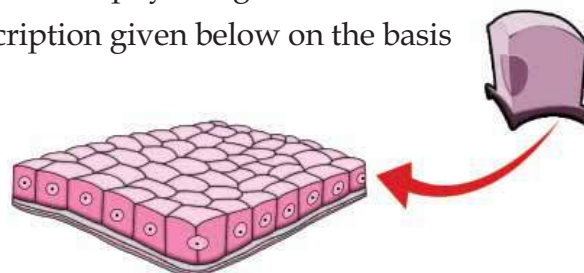

From a single cell !

Our body is developed from a single cell called zygote. The zygote undergoes continuous divisions and forms the foetus consisting cells of different shape, size and content. Foetal cells gradually attain change in structure and function. This process is known as cell differentiation.

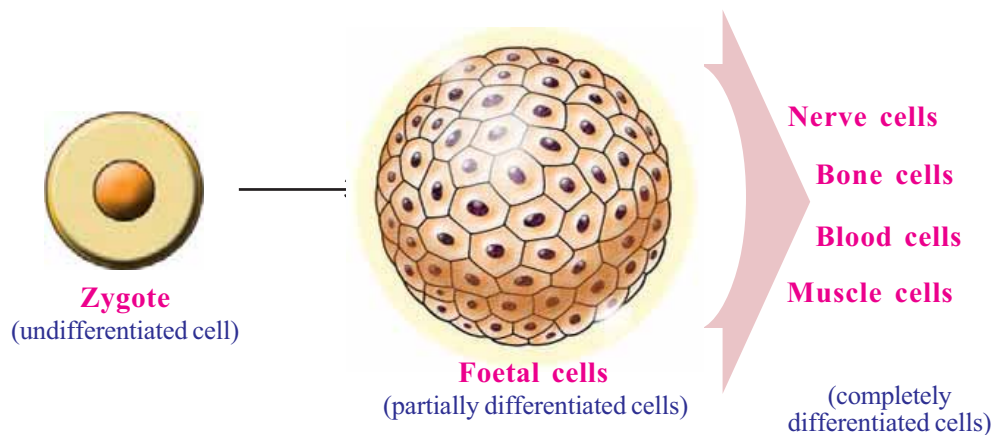
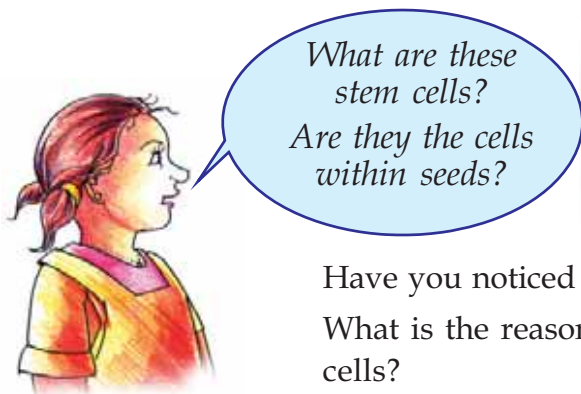

Illustration 2.2

Indicators

- Formation of foetus.
- Significance of cell differentiation.

Write down the consolidation of the discussion in the science diary.



A giant leap in stem cell research

Science has succeeded in artificially developing tissues from stem cells. A lot of research has gone into this achievement, which would become a milestone in the field of medicine.

Have you noticed Sneha's doubt about the newsclipping?

What is the reason for the immense popularity gained by stem cells?

Have a discussion on the description given below on the basis of the indicators.

Stem cells

Stem cells are specialized cells that can transform into any kind of cells. Stem cells undergo constant differentiation and get transformed into other kinds of cells.

Stem cells can either get transformed into other cells through division or exist as such. When the cells in the tissues get destroyed, new cells develop from the stem cells. Stem cells are found in the bone marrow, skin, digestive tract etc.

Nowadays, science can develop the desired type of cells from stem cells, in research centres, under specific laboratory conditions.

It is expected that the research of stem cells can bring about miraculous changes in the treatment of Blood cancer, Diabetes, Parkinson disease etc., and also in the manufacture of artificial organs.



Blood vessels developed from the stem cells in blood.

Indicators

- What are the peculiarities of stem cells when compared to other cells?
- How is the destruction of cells in tissues compensated?
- Why is stem cell research gaining importance?

Record the consolidation of your discussion in the science dairy. Now let us read about the different types of animal tissues.

Animal tissues

Epithelial tissue



- covers and protects the body.
- lines the inner wall of the digestive tract.
- performs functions such as protection, absorption and production of secretions.

Nervous tissue

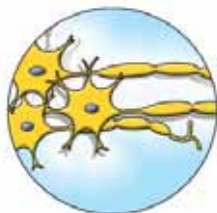

- controls and coordinates physiological functions.
- enables to respond identifying the changes inside and outside the body.

Muscular tissue

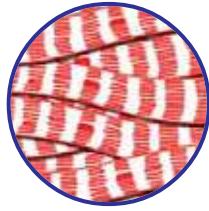

- consists of cells that can contract and regain the original state.
- enables the movement of the body.

Connective tissue

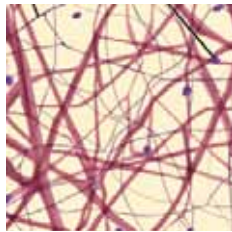

- either connects different tissues or acts as a support to them. Bone, cartilage, fibrous tissue, blood etc., are various connective tissues.
- Bone and cartilage provide support, protection and a definite shape to the body.
- Fibrous tissue connects other tissues.
- Blood carries out the conduction of materials and makes the body resistant to diseases.



Connective Tissues

As the name suggests, connective tissues bind other tissues together. Tendons that connect muscles to the bones, ligaments that connect bones together and fibrous tissues that hold the eyes and kidneys in the proper place are examples for connective tissues.

Bone and cartilage, that are connective tissues help in movement and provide shape, support and strength to the body. Besides, they cover and protect internal organs.

Blood, the fluid tissue, also belongs to the group of connective tissues. Blood carries out various functions like transporting respiratory gases and nutrients, providing immunity etc.

Connective tissues are the most diverse and the largest in number in our body.

Observe the slides of animal tissues through a microscope with the help of your teacher. Prepare an illustration showing different types of tissues and their functions.

*How fast does this tree grow!
Why can't I grow like it?*



You too may have had such doubt.

Is growth in plants and animals alike?

Discuss.

Growth in plants is mainly centered at the tip of stems and roots. But, in animals, growth is not confined to any specific area.

Why does growth in plants occur at specific areas?

Find the answer by analysing the following description.



Meristematic tissues

Meristematic cells are specific cells seen at the tip of the stem and the root in plants. They undergo rapid division and this results in the growth of plants.



Compare the figures of a meristematic cell and a mature cell. Find out the differences and complete the table.

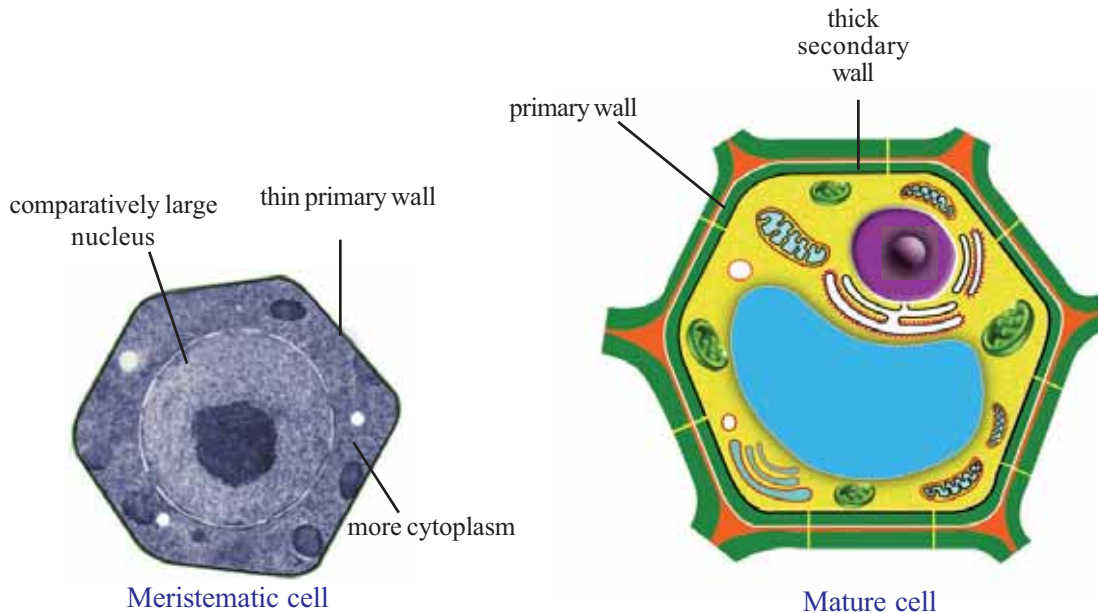

Fig 2.1

Characteristics	Meristematic cells	Mature plant cells
• Relative size of the nucleus		
• Thickness of the cell wall		
• Quantity of cytoplasm		

Table 2.1

Different types of plant tissues are formed from meristematic cells. Parenchyma, collenchyma, sclerenchyma, xylem, phloem etc., are

different types of plant tissues. Let's observe these tissues through a microscope.

Observe the structure of a plant stem and prepare a note based on your observations. Identify the tissues observed with the help of Figure 2.2.

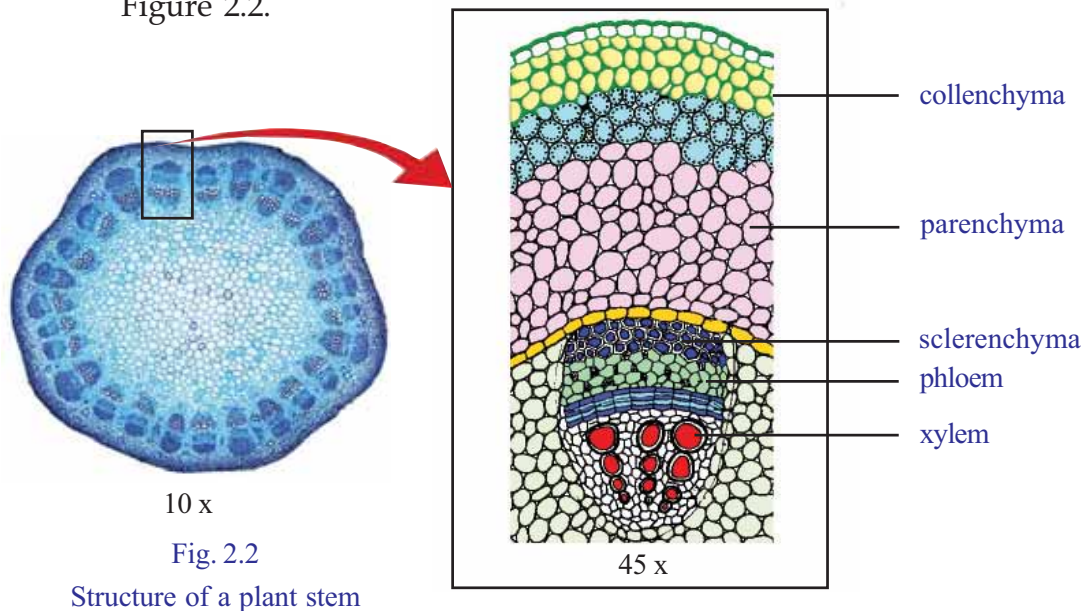

Analyse the information given below and try to understand more about plant tissues.

Plant tissues

Parenchyma

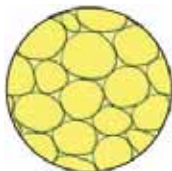

- composed of cells with the simplest structure.
- seen in the soft parts of the plant.
- helps in photosynthesis and the storage of food.

Collenchyma



- composed of cells that are thick only at the corners of the cell wall.
- provides flexibility and support to plant parts.

Sclerenchyma



- composed of cells that are uniformly thick all over the cell wall.
- provides strength and support to plant parts.

Vascular tissues

The water and minerals absorbed by roots need to be transported to leaves and the food prepared in leaves need to be transported to different parts. The specialized tissues formed from peculiar cells to do this are called vascular tissues. They are called complex tissues because they are formed from different kinds of cells. The two types of complex tissues found in plants are xylem and phloem.

Xylem

- tubes formed from elongated cells.
- transports water and minerals absorbed by the roots to the leaves.
- has thick cell walls and therefore provide support and strength to the plant.

Phloem

- composed of tubular inter-connected cells.
- transports food synthesized in the leaves to various parts of the plant body.

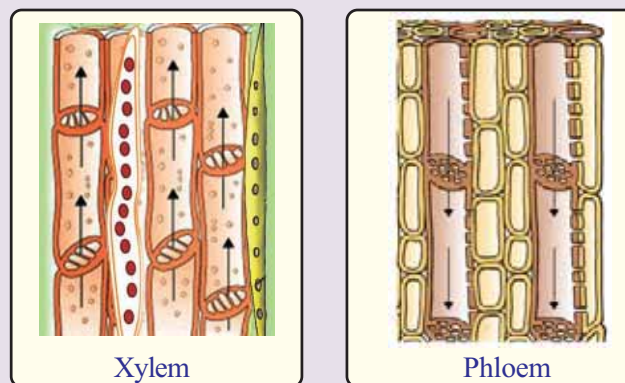
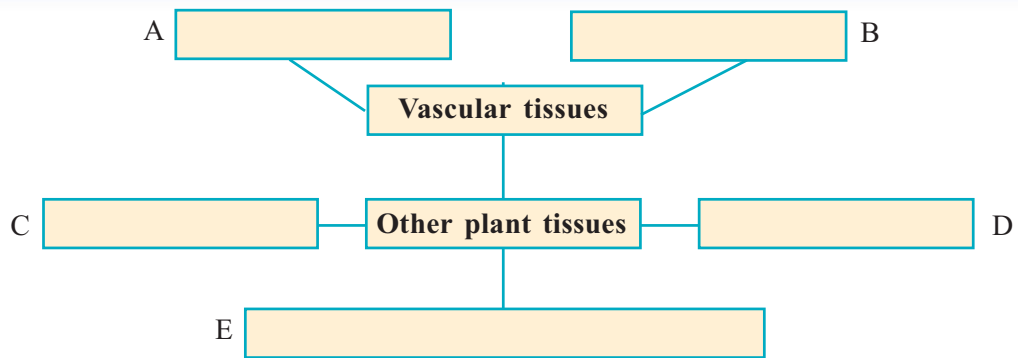

Fig 2.3

Now you have understood the different types of plant tissues and their characteristics. Complete the following worksheet based on the hints given below.

- transports food prepared in the leaves to various parts of the plant.
- transports water and minerals absorbed by the roots to the leaves.
- seen in the tender parts of the plant.
- only the corners of the cell walls are thick.
- cells that are uniformly thick all over the cell wall are seen.



Cells combine to form tissues.
What if tissues combine...?

Write your response to this.

Do tissues work together just as the cells do?

Based on the indicators, analyse the illustration given below.
Write your inferences in the science diary.

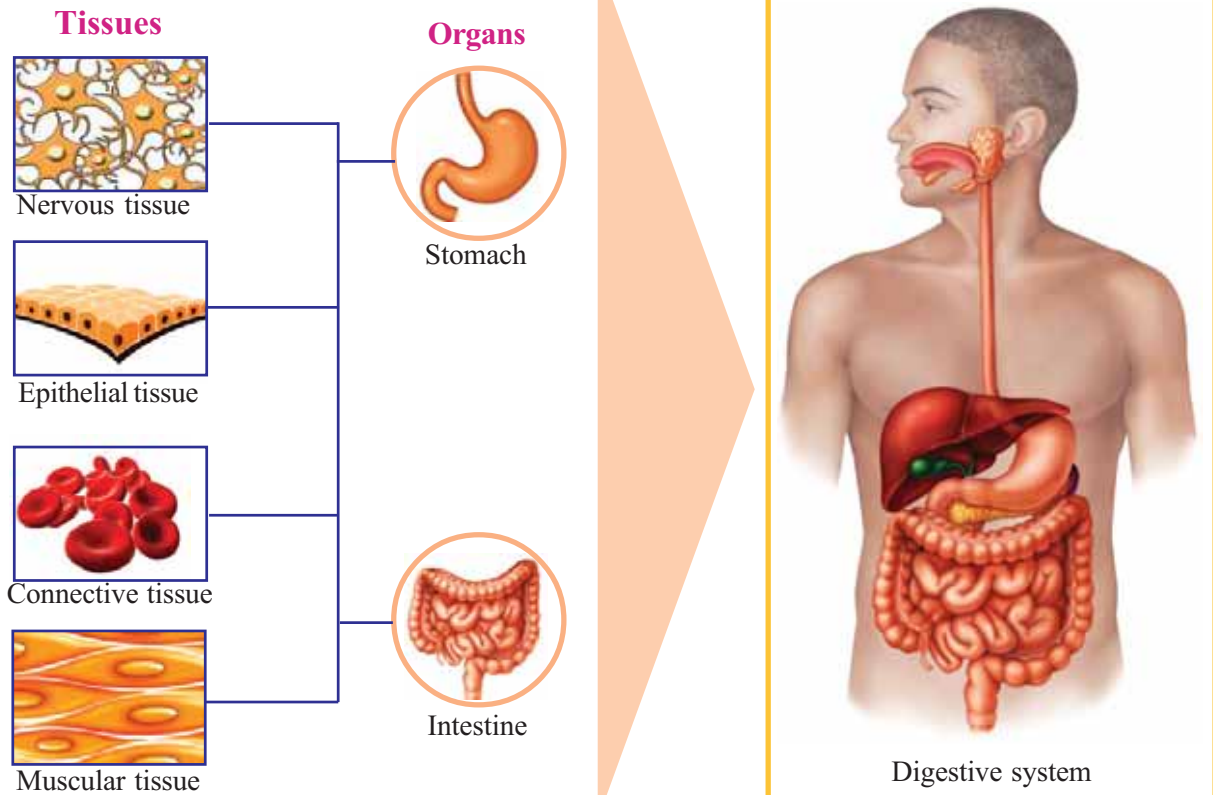

Illustration 2.3

Indicators

- What are the functions performed by each tissue in the illustration?
- What are the important tissues that the stomach and the intestine are made up of?
- What is the function of the stomach?
- What is the function of the intestine?
- Is the function performed by an organ the same as the function of its constituent tissues?
- What is the advantage of organs with the same function working together as a system?

Tissues combine to form organs. What would happen when organs combine? Discuss.

•

Physiological functions are smoothly carried out by the combined action of many organs. Digestion is the process of the combined action of organs of the digestive system such as stomach, liver and intestine. Whether the functioning of the digestive system alone is sufficient to transport the nutrients produced by digestion, to different parts of the body? Discuss.

•

Complete the following table by finding out the systems to which the organs listed in the table belong to:

Organs	Organ system
Heart, blood vessels	
Nose, trachea, lungs	
Kidney, ureter, urinary bladder	
Brain, nerves	

Table 2.2

No organ system can function independently. A given physiological activity can be completed only by the combined action of different organ systems.

You have understood that cells combine to form tissues, tissues combine to form organs and organs combine to form organ systems.

Discuss what happens when organ systems combine together.



For more details and pictures of tissues
[http://en.wikipedia.org/wiki/Tissue_\(biology\)](http://en.wikipedia.org/wiki/Tissue_(biology))

Aren't you now convinced that an organism is a combination of different organ systems?

An organism can survive only when these organ systems work in a coordinated way.

As organ systems become complex, the structure of the body also becomes complex. The structure of higher order animals including human beings is complex, as it is formed by a combination of various organ systems.

Do all organisms have an organ system?

However unicellular organisms also exist on the earth?

Discuss.

Cell is the basic unit of life.

Parts of the cell are formed of various substances.

You might have learnt that all substances are basically formed of atoms.

Observe the illustration which shows the levels of organisation from atom to community. Prepare a note and record it in your science diary.

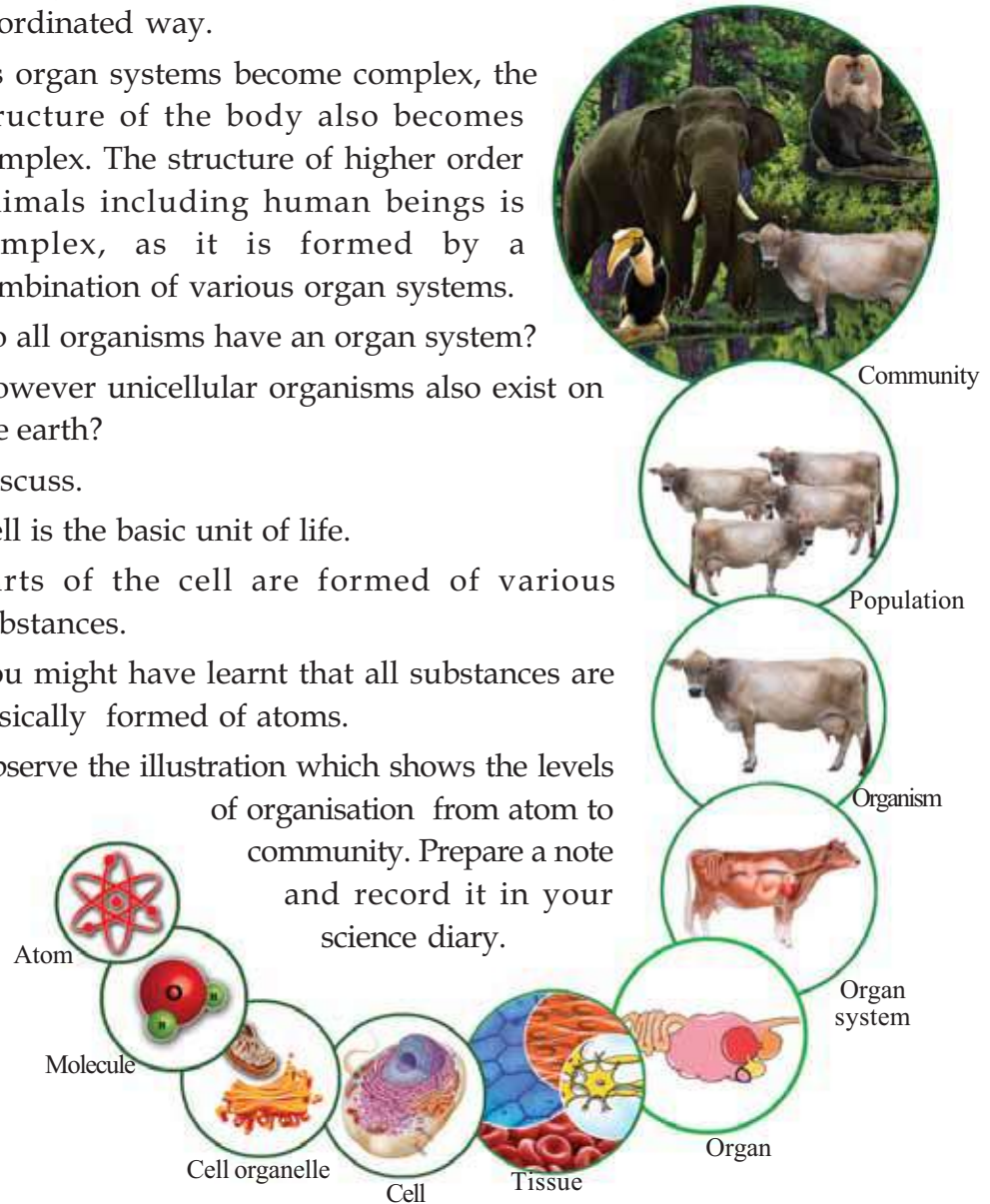

Illustration 2.4

A complex living body is formed by the continuous division and differentiation of cells. In organisms that belong to higher levels of organization, different types of tissues act complementarily to perform several complex physiological activities. Efficiency of the organisms increases with the variety of its tissues. Hope you have understood the importance of functioning together. Isn't it relevant in our social life too?



Significant learning outcomes

The learner can

- identify and explain the formation of tissues from cells.
- identify and explain the characteristics and functions of animal tissues.
- list the characteristic features of meristematic cells.
- identify and explain the formation of different types of cells from the zygote.
- identify the structure of various plant tissues and list their functions.
- identify and illustrate different levels of organization in organisms.



Let us assess

1. Given below in the illustration are various tissues related to the structure of hand.

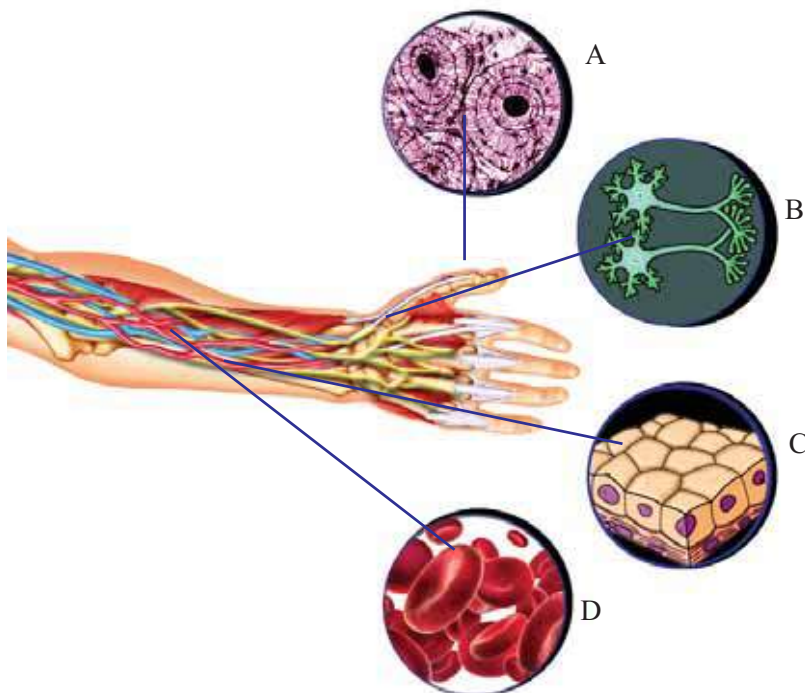

Observe the illustration and write the alphabet suitable to each statement.

- provides support, protection and shape:.....
- covers the body parts :

- transports substances :
 - helps to respond by recognizing changes:
2. Which among the following statements is not related to tissues?
 - a. different types of cells are seen.
 - b. similar kinds of cells are seen.
 - c. performs specific function.
 - d. formed from different cells.
 3. Which indicator helps to identify collenchyma when it is observed through a microscope.
 - a. thin cell wall.
 - b. uniformly thick cell wall.
 - c. no nucleus in the cell.
 - d. only the corners of the cells are thick.



Extended activities

1. Arrange an exhibition showing pictures and descriptions of different types of cells.
2. Prepare a magazine specifying the importance, relevance and scope of stem cells.



Unit
3

Let's Regain our Fields

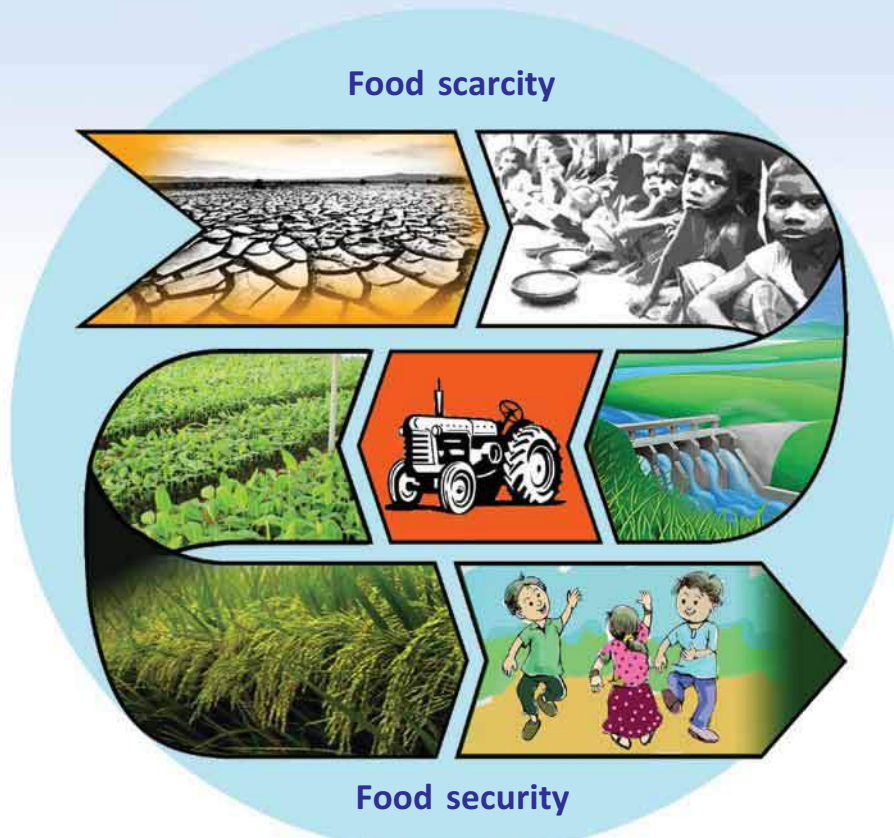

Illustration 3.1

Didn't you notice the illustration and the newspaper report ?

What is the concept indicated by the illustration?

Discuss it with your friends using the given indicators. Write your inferences in the science diary.

- reasons for the scarcity of food.
- role of science in solving the problem.
- relevance of food security.

Loksabha passes Food Security bill

New Delhi :The Loksabha has passed the Food Security bill. The bill ensures the distribution of food grains at a lower rate. The bill has been legalized to distribute rice at a price of 3 rupees and wheat at 2 rupees per kilogram.



For a prosperous future

Food security is the situation that ensures sufficient food for everyone to lead a healthy life. It is necessary to ensure food security for a better and healthy society where there is no poverty or health issues due to lack of nutrition.

Isn't rice our staple food? Examine the table given below related to the production of rice in Kerala. Analyse the information based on indicators and write the inference in the science diary.

Year	Rice production		Population (in crores)
	Area of land for Cultivation (in lakh hectares)	Production (in lakh tonnes)	
1971	8.75	13.65	2.13
1991	5.5	10.6	2.91
2011	2.08	5.69	3.34

Courtesy : Janapatham

Table 3.1

Indicators

- What were the changes that occurred in the area of agricultural fields from the year 1971 to 2011?
- What tendency could be observed in rice production and population growth during the period?
- Is this tendency desirable? Why?

We have so far examined only the production of rice. The case is not different with other food items too.

How is it that we have to depend on other states for fruits, vegetables, egg and meat?

It is a challenge to ensure food security in a situation when cultivable land is decreasing. It is essential to recreate a culture of love for the soil and agriculture. Regaining lost cultivable land is also important. Only through a comprehensive approach can we reduce our excessive dependence on others for food.

Crises in the agricultural sector

What are the obstacles faced by farmers today?

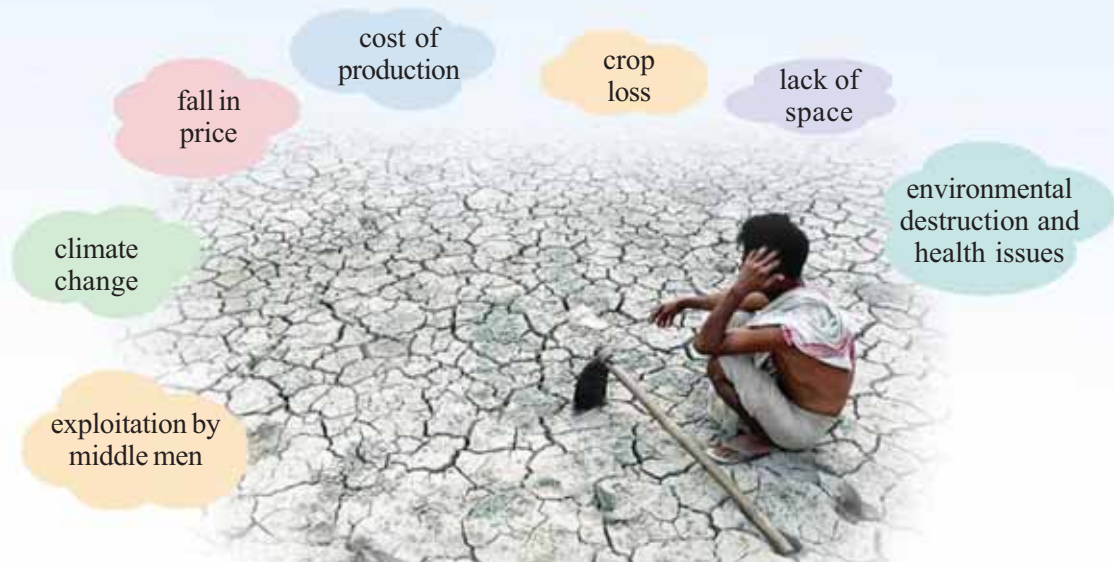

Fig 3.1

Prepare a note using the indicators in the picture and by adding more information.

Don't you think that many problems can be overcome if the approach to agriculture is made scientific? Let us examine the possibilities to overcome each issue.

Discuss the description given below based on the indicators. Write your inferences in the science diary.

Fertile soil, the basis of food security

About 20 different elements are required for the proper growth of plants. They are known as essential elements. Carbon, hydrogen, oxygen, nitrogen, phosphorus, potassium, sulphur etc., are examples of essential elements.

These elements are made naturally available in the soil through decomposition by microorganisms.

Haven't you learnt the advantages of growing leguminous plants in fields? Besides this, the fertility of the soil can be improved through the application of fertilizers too. The pH of the soil is also an important factor that influences the growth of the plants. The presence of elements in the soil and the pH value can be identified by soil testing. Organisms like bacteria, fungi, algae, termite, earthworm etc., help to increase soil fertility.

Indicators

- What is the role of microorganisms in ensuring the natural availability of elements in the soil?
- What is the need of testing the soil?
- Why does the application of fertilizers become essential for better crop yield?

Farmers use different kinds of fertilizers in order to increase the fertility of the soil. You are familiar with different kinds of fertilizers such as chemical fertilizers, bio-fertilizers, green leaf manure etc. Now observe the picture below.



Read the pamphlet Geethu got from the Agricultural Officer when she sought to clarify certain doubts.

Microbes that provide fertilizers

Microbial fertilizers are substances that contain microorganisms which help to increase the fertility of soil. The presence of microbes enables increase in the soil factors which are essential for plant growth. Bacteria like *Rhizobium*, *Azotobacter*, *Azospirillum* and aquatic plants like *Azolla* can be used to increase nitrogen content in the soil.

Things to be taken care of

- ensure the availability of biofertilizers in the soil.
- proper irrigation should be provided.
- chemical fertilizers or chemical pesticides should not be used.

Microorganisms can exist in soil only if these precautions are taken.

What are the consequences of unscientific application of chemical fertilizers? Discuss on the basis of the following indicators.

- composition of soil
- microorganisms in soil
- health issues
- financial factors

Organise an exhibition for creating awareness among farmers.

To control pests

Isn't pest infestation yet another important problem faced by our farmers? People generally apply chemical pesticides to overcome this.

Chemical pesticides destroy pests totally. But when the pests acquire resistance, the quantity of pesticides has to be increased.

Excessive application of chemical pesticides causes many environmental and health issues.

Now read this newspaper report.



Cancer patient toll on the rise.

Thiruvananthapuram :The wide use of chemical pesticides is suspected to be an important reason for the increase in the number of cancer affected persons. The presence of pesticides identified in even ground water has become a matter of great concern.

In this situation, isn't it important to adopt pest control measures that are not harmful to our health and nature?

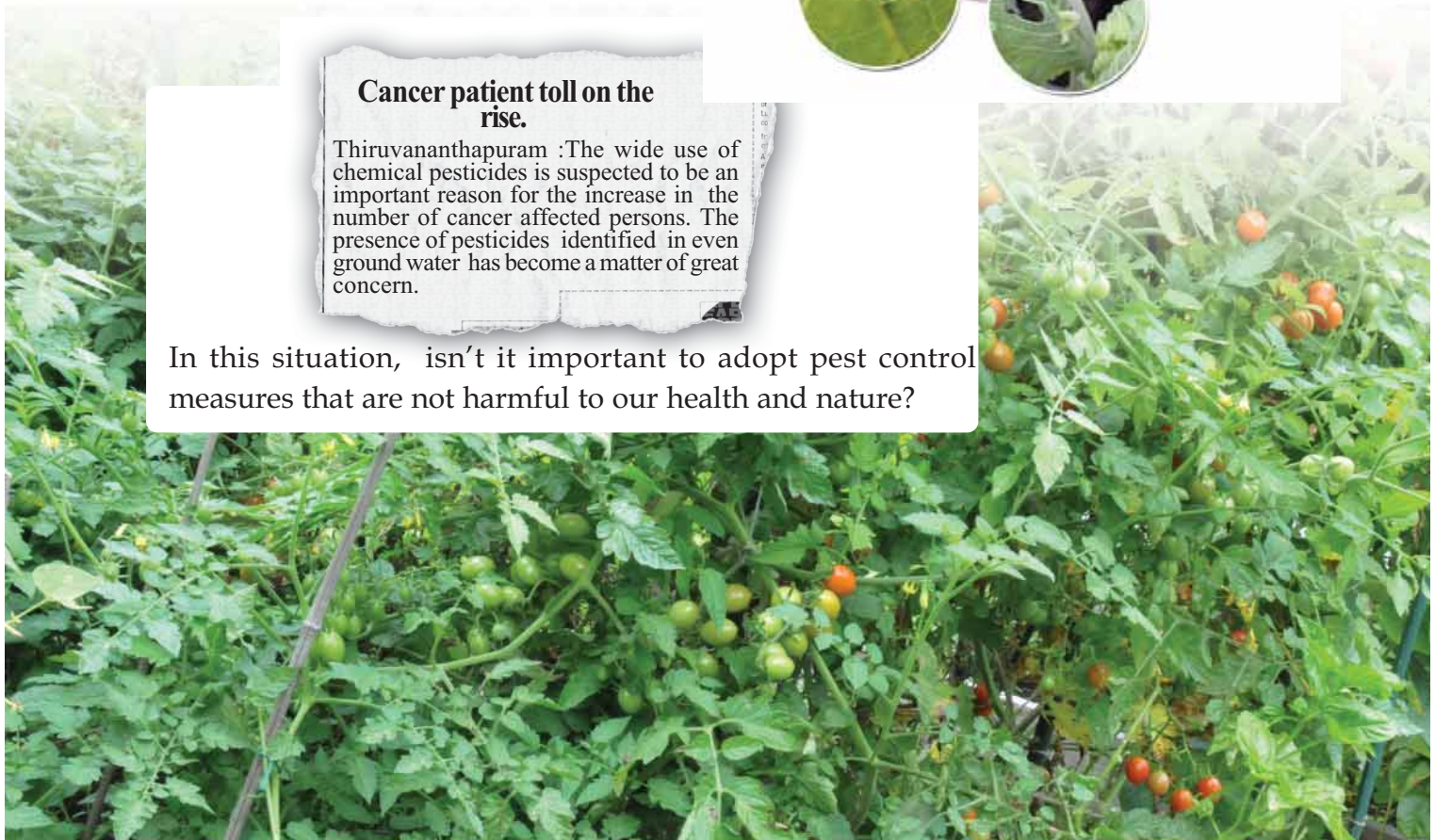



Modern technology and pests

With the large scale production of chemical fertilizers research in other areas of pest control has not been encouraged adequately. Although it is proved that pests can be controlled by using ultrasonic sound waves, such technologies are not accessible to farmers.

Another possibility of controlling the multiplication of pests is destroying the reproductive capacity of male pests using radiations.

Devices like pheromone trap are becoming more widespread. The method employed here is to attract and destroy insects using artificial substances that have a chemical nature similar to that of pheromone emitted by insects. Its demerit is that it is easily evaporated by heat and wind and dissolved by water. However, now, with the help of modern technology, it is possible to develop artificial pheromone traps which are not exposed to any chemical and physical change.

Read the science excerpt given below.

Pests and their natural enemies

Have you ever thought of the tremendous increase of certain pests? The main reason for this is the fall in the number of organisms that prey on them. Predators, parasites and pathogens of pests can be called natural enemies of pests. The service of these organisms may be effectively utilized in agriculture.



Integrated Pest Management-IPM

The basic principle of Integrated Pest Management is not the destruction of pests totally. Instead it tries to prevent the multiplication of pests and to limit their number without loss of crop.

This ecofriendly method ensures pest control without disturbing the environment. This is done by reducing the use of chemical pesticides and encouraging the application of biopesticides, natural enemies of pests, mechanical pest control etc.

Measures of pest control that do not cause any harm to the environment are desirable. Let us list the advantages of Integrated Pest Management.

-
-
-



See 'Keedaniyanthranamargangal'.
in School Resources in IT @
School, Edubuntu.

The high investment required for agriculture makes it uneconomic. The high cost of seeds, fertilizers and pesticides, makes the farmer a debtor.

The decline in the fertility of soil and the increase of pests compel peasants to use fertilizers and pesticides in greater quantities.

But though the excessive use of fertilizers and chemical pesticides provide profit for a short period, gradually the land may become barren.

It is in these circumstances that the concept of sustainable agriculture becomes relevant. Here the method adopted is to reduce the use of fertilizers and pesticides and to make one's decaying matter a manure for another. Diverse crops are seen in the fields adopting this method. No waste remains. By giving importance to the cultivation of food crops, market dependency and price hike can be reduced. Conservation of biodiversity also becomes possible by cultivating native varieties of crops.

Waste management and sustainable agriculture

One of the main problems faced by modern society is the disposal of organic waste. Will sustainable agriculture be an answer for this? Discuss with the help of the given indicators and write your conclusions in the science diary.

- composting
- biogas production
- fodder production
- poultry fodder production
- production of fish feed



Fig 3.2 Biogas plant



The changing perspective

High yield seed varieties were widely popularised as part of the efforts to increase agricultural production, to meet the demands of the increasing population. This was accompanied by wide use of fertilizers and pesticides. In this practice, since the seeds and fertilizers are brought from outside to the agricultural field, this method may be called HEIA (High External Input Agriculture). However, this method was criticized for its heavy expense and its adverse effect on health and environment. Gradually, LEISA (Low External Input Sustainable Agriculture) began to receive wide recognition. LEISA emphasises the perspective that only agriculture with minimum use of external materials can be sustainable. This method allows the use of fertilizers and pesticides in limited quantity, under emergency situations. As a stage ahead, this method envisages NEISA (No External Input Sustainable Agriculture) as a possibility, wherein one's waste becomes the manure for another and therefore sustainable and not dependent on anything from outside.

Reaping diversity

There are different agricultural sectors which help to earn better income through a scientific approach. Let us try to familiarize ourselves with a few farming methods that can be chosen on the basis of their nature and scope.

Livestock management

Rearing cattle for milk, meat and agricultural purposes.

Important varieties of cattle

Cow : Jersey, Holstein Friesian, Vechoor

Buffalo : Murrah, Niliravi, Bhadawari

Goat : Thalassery, Jamnapari,
Boer



Poultry farming



Rearing birds for egg and meat.

Chicken varieties : Athulya, Gramalekshmi, White Leghorn

Duck varieties : Muscovy, Chara, Chemballi

Quill varieties : Japanese, Bob white.



Sericulture



Rearing silkworms for the production of natural silk is called sericulture. Silk is formed from the special glands of the larvae of the silk moth. Mulberry silkworm, Tussar silkworm, Muga silkworm etc., are the major varieties.

Pisciculture

The scientific way of rearing fish in natural water bodies, paddy fields or artificial tanks, is pisciculture. Varieties such as Pearl spot, Rohu, Catla etc., are reared for food and Gold fish, Guppy etc., are reared for ornamental purposes. Important prawn varieties reared are Naran, Kara etc.

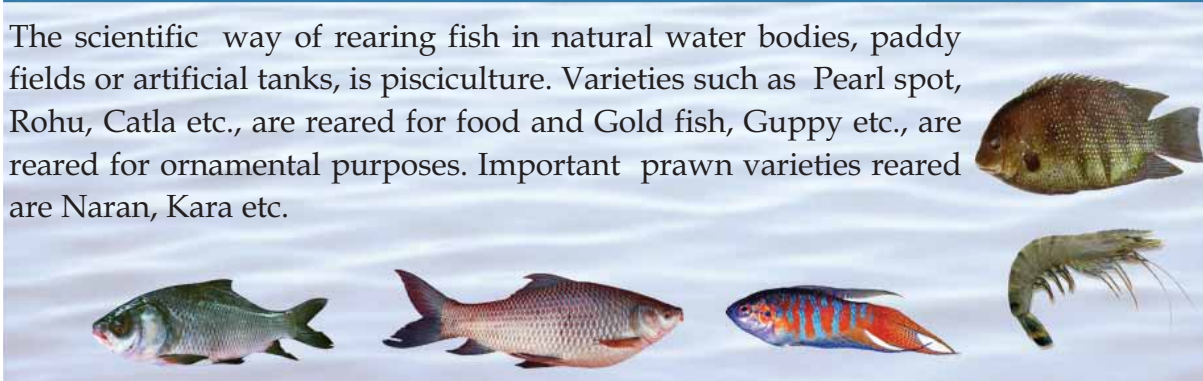

Floriculture



Cultivation of flowering plants on a commercial basis. Jasmine, Marigold, Chrysanthemum, Rose, Orchid, Anthurium etc., are flowers of commercial demand.

Apiculture

Scientific rearing of honey bees. Honey is a product of medicinal and nutritional value. Varieties of honey bees like Kolan, Mellifera, Njodiyana etc., are reared commonly.



Cuniculture



Scientific way of rearing of rabbits. Varieties like Grey giant, White giant etc., are reared for meat. Ankora is reared for fur.

Mushroom culture



Scientific way of growing mushroom. Mushroom is a nutritious and tasty food item. Button mushroom (*Palkoon*), Oyster mushroom (*Chippikoon*) etc., are commonly cultivated mushroom varieties.

Horticulture

Scientific cultivation of fruits and vegetables. Besides indigenous varieties, exotic varieties like Litchi, Rambutan, Durian etc., are cultivated in our land.



Medicinal plant cultivation

The Indian system of medicine 'Ayurveda' exists completely depending on medicinal plants. The popularity of Ayurveda and the destruction of natural ecosystems have raised the importance of medicinal plant cultivation. Basil, Aloe, Neem, Adathoda, Sida (*Kurunthotti*), Vettivera (*Ramacham*), Aegle marmelos (*Koovalam*), Plumbago (*Koduveli*) etc., can be grown in crop fields.



Complete the following table related to various agricultural sectors.

	Sector	Products	Varieties
	Pearl spot, Rohu
	Honey, wax
	Mushroom culture
	Livestock management
	Ankora, Grey giant

	Poultry farming

Table 3.2

*Come on farmers ...
be hitech*

Farmers in the district have been encouraged to enter hitech farming...

Haven't you noticed the newspaper report?

What are the advantages of adopting modern agricultural practices?

- can increase production
- can control weeds and pests
-

Climate change is another important crisis in the agricultural sector. The unpredictable climate adversely affects traditional farming methods. The techniques that are used to overcome these challenges are gaining currency nowadays. Familiarize yourselves with some such new techniques.

Discuss the given information based on indicators and write the inferences in your science diary.

Polyhouse Farming

Polyhouse is a special kind of arrangement in which a crop field is completely or partially covered by transparent polyethene sheets. Since the temperature and moisture in the polyhouse is constantly regulated, growth of plants becomes rapid. Nutrients are dissolved in water and are supplied on plants through drip irrigation. Pest infestation will also be less because the sides of the polyhouse are covered with net. Although the expense is high in the beginning, crop yield is many times greater than that of the regular field.



Fig 3.3
Polyhouse farming

Precision Farming

In this method of farming, the nature of soil, quantity of elements in the soil, pH value of soil, presence of water etc., in the crop field are tested using modern technology, and appropriate crops are selected for cultivation. By covering the soil using polythene sheet, we can effectively control weeds and also limit irrigation.



Fig 3.4
Precision farming

Cultivation without soil !

Can we grow plants without soil? If so, is it possible to overcome the crises in agriculture like climate change, change in soil texture, lack of irrigation facility etc? Science has proved that cultivation is possible in the absence of soil even though there are limitations to popularize it as a method of cultivation. Aeroponics and hydroponics are examples for this.

In hydroponics, plants are grown in nutrient solution. In aeroponics, plants are grown in such a way that their roots grow into air and nutrients are sprayed directly, on roots.



Fig 3.5
Hydroponics



Fig 3.6
Aeroponics

Indicators

- How are modern agricultural practices helpful in reducing crop loss due to climate change?
- What are the advantages of precision farming?
- How does cultivation become possible without depending on soil?

In modern agricultural practices, hybrids are used to ensure productivity. There are also arguments in support of a return of traditional agricultural practices because it is beneficial to nature and humans. It also argues that modern methods have many limitations. In traditional agricultural practices, indigenous varieties are used.

Is it essential to retain indigenous varieties when many hybrid varieties are available? Note down your opinion.

Read the description and check the validity of your opinion. Collect more information on this topic and organize a debate in your class.

Native Varieties for tomorrow...

Indigenous varieties of a locality are varieties that acquire natural immunity by adapting to the climate, the availability of food, soil texture of that place etc. We had many cattle varieties of high disease resistance and low cost of management, though they were less productive. We also had crops of diverse taste and nutrients. Many indigenous tuber crops are disappearing today. Dioscorea (Kachil), taro, arrow root (Koova) etc., have been eliminated from our diet. We must realize that through the extinction of these food crops, that are rich in nutrients and easy to cultivate, we are losing invaluable treasure.

Extinction of indigenous varieties causes depletion of our biological wealth. We can develop new high quality varieties only from indigenous varieties that can survive the challenges of adverse climatic conditions. We mustn't ignore the reality that these valuable resources cannot be regained if lost once.

Given below are a few indigenous varieties.

Expand the table collecting more information.

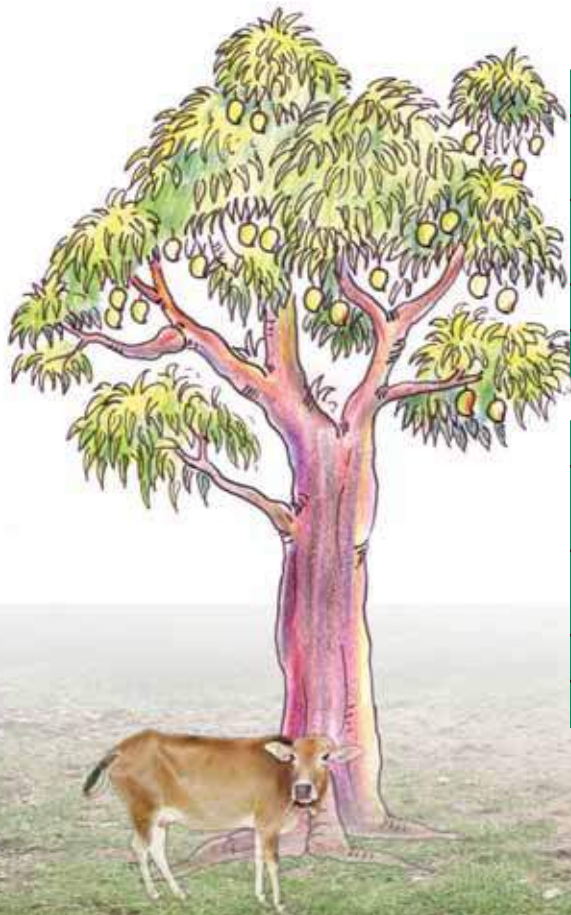

Crop	Varieties
Mango	Muvandan Kilichundan
Plantain	Njalipoovan, Palayamkodan

Table 3.3



Animal	Varieties
Cow	Vechoor, Kasaragod Kullan
Goat	Malabari, Attappadi black

Table 3.4

Agriculture should be a means, for farmers, to lead a life without hurdles. One of the crises faced by farmers is the fall in price of products and exploitation by middle men. How can this be overcome? Discuss and formulate an opinion.

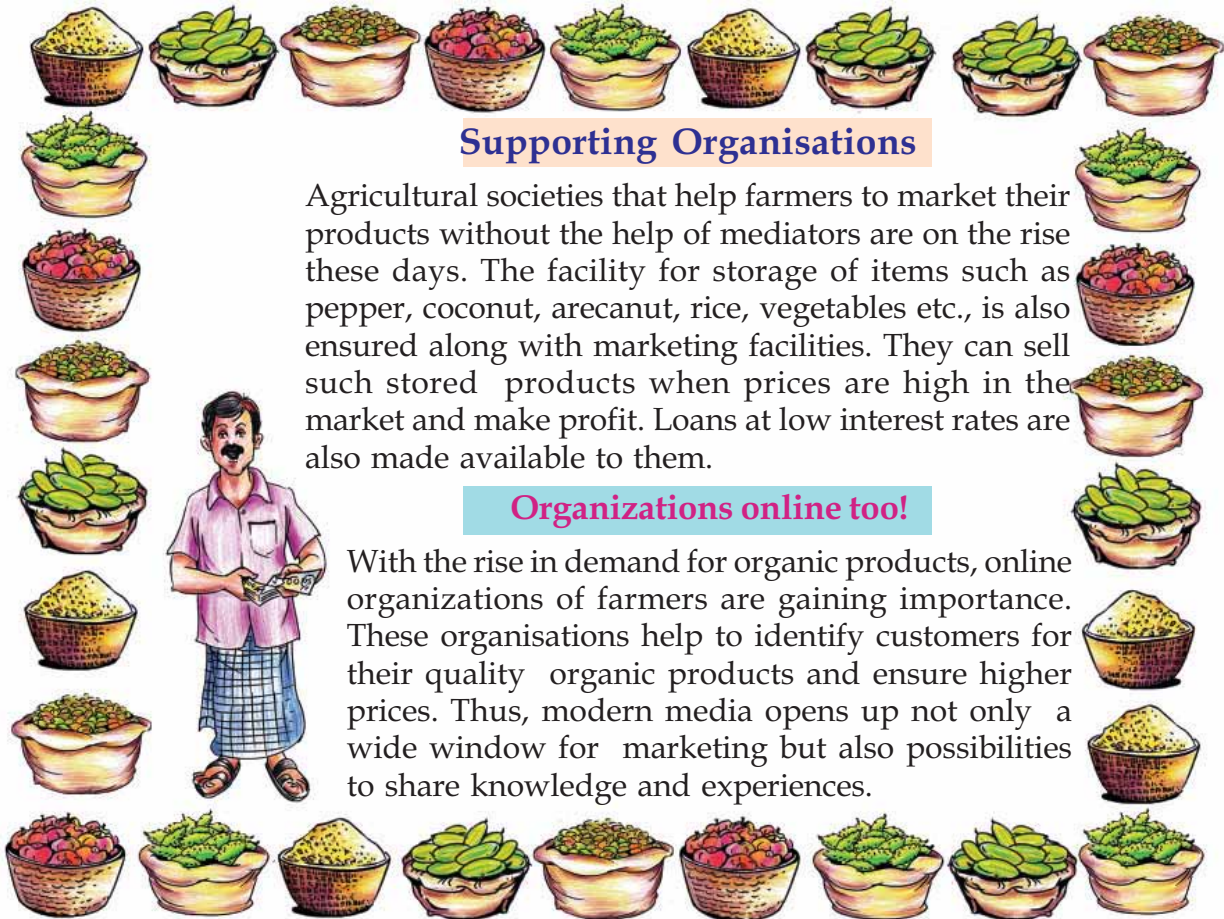

Supporting Organisations

Agricultural societies that help farmers to market their products without the help of mediators are on the rise these days. The facility for storage of items such as pepper, coconut, arecanut, rice, vegetables etc., is also ensured along with marketing facilities. They can sell such stored products when prices are high in the market and make profit. Loans at low interest rates are also made available to them.

Organizations online too!

With the rise in demand for organic products, online organizations of farmers are gaining importance. These organisations help to identify customers for their quality organic products and ensure higher prices. Thus, modern media opens up not only a wide window for marketing but also possibilities to share knowledge and experiences.

It is not sufficient to make agriculture productive and sustainable. One should realize that agriculture is not the sole responsibility of farmers. People working in other fields must also try to engage in agriculture in a limited way atleast. The concept of 'agriculture for all in society' is relevant here.

Is this concept practical? Do we have enough time to spend on cultivation in the midst of the busy life? Isn't it easy to buy things from the market? Such doubts may naturally occur in our minds.

Read the diary of a farmer.



2014

Sun	Mon	Tue	Wed	Thu	Fri	Sat
	1	2	3	4	5	6
7	8	9	10	11	12	13
14	15	16	17	18	19	20
21	22	23	24	25	26	27
28	29	30	31			

December 15

- Many things fall into sight during my morning walk through the fields.
- Following the advice of the Agricultural Officer, the soil was tested and lime was added became useful. Fruit borers have started attacking the vegetables here and there. It is time for the application
 - of tobacco decoctions. The best pods from pea plants should be collected for seed. A lot of night soil (kuruppa) can be seen. Earthworms must have multiplied. The arecanut saplings have worn
 - out being exposed to sunlight. It is necessary to provide them shade or whitewash their trunks. On the advice of a friend, I also tried land paddy cultivation. There was no need to use chemical fertilizers or
 - chemical pesticides. Since it was an indigenous variety of rice. How nice it is to see the plants raising heads high in the lush green! Such a diet that includes rice and vegetables is not only profitable but
 - also one provides taste, health and satisfaction. How can this be rated? The result of hard work! Something to be experienced. How nice that I could spare some time for farming!

Did you read the diary note? Is the concept 'agriculture for all in society' possible? Note down your opinion.

.....

Do you think that the agricultural practices of the farmer is scientific? What is the scientific method? Read the following note.

The scientific method includes identifying the problem, collecting information through observation, experimentation etc., analysis of collected information, formulation of proper inference and improvement of the inference through continuous enquiry. Scientists follow this method. Science is a means to solve problems by applying acquired knowledge as well as to create a better future.

Does the diary note of the farmer contain the elements of the scientific method like identifying the problem, observation, experimentation, collection of information etc.? Examine.



The farmer is one who applies the scientific method. Isn't it clear now that a real farmer is, in fact, a scientist?

These scientists are the ones who sustain a society. People who deserve recognition more than any others! While eating, do we recollect that it is the result of the hard work of a farmer?

The number of people engaged in agriculture, either individually or in groups, is increasing. The reason behind it is the awareness of the need of fresh, pure food. Are there group activities such as 'Sunday farming', 'Family farming' etc., in your locality? What are the advantages of this?

- utilization of barren land
- pesticide free food
- exercise for the body
- recreation
-

There are many people today who wish to set up their own vegetable garden, after realizing the seriousness of health problems caused by food items that contain pesticides. What are the main obstacles in their way?

- lack of space
- availability of seed
- ignorance of nurturing
-

Examine the pictures and the news paper report collage. Analyse the possibilities to overcome the above said limitations.



Fig. 3.7
Terrace cultivation



Fig. 3.8
Grow bag cultivation



Fig. 3.9
Vertical farming

There are many institutions which make available facilities for agriculture. The government plans and implements many projects to promote agriculture. Awards are instituted in order to encourage youngsters into agriculture and to recognize outstanding skills. Collect more information on this.

This chapter deals with the possibilities to overcome some crises in the agriculture sector.

Complete the following table, adding important ideas.

Crises	Possibilities to overcome
Climate change	<ul style="list-style-type: none"> • Polyhouse farming • Hydroponics
Environment destruction and health problems	<ul style="list-style-type: none"> • Scientific application of fertilizers • Integrated pest management • Organic waste disposal
Cost of production	<ul style="list-style-type: none"> • •
Crop loss	<ul style="list-style-type: none"> • •
Lack of space	<ul style="list-style-type: none"> • •
Fall in price	<ul style="list-style-type: none"> • •

Table 3.5

Many issues are yet to be discussed. You have the knowledge and experiences related to the topics of previous classes. Organise a seminar in the class collecting more information from farmers, research institutions and the media.

Let us also do all that we can to fulfill the concept 'agriculture for all in society'. Do not forget to prepare a diary note while you engage in agriculture. Exchange the diary notes amongst yourselves and publish them as a volume.

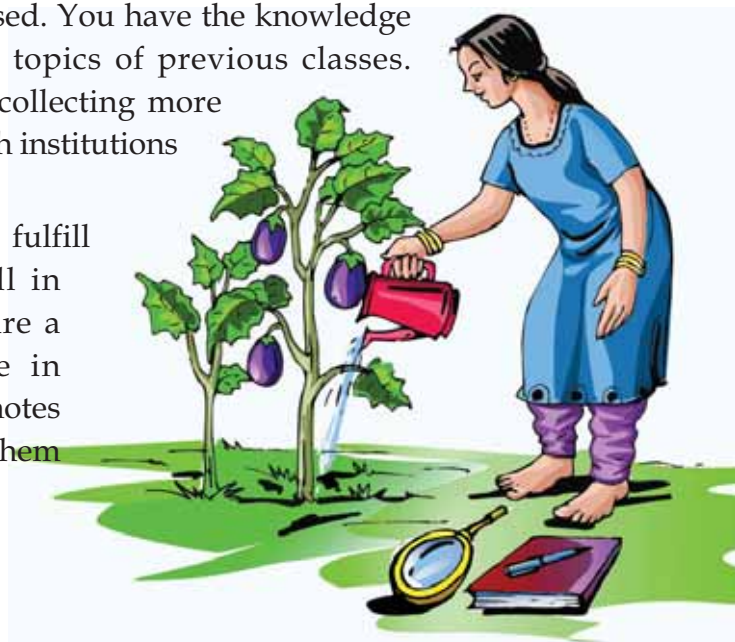



Significant learning outcomes

The learner can

- explain the idea of food security.
- explain methods of integrated pest management and identify their advantages.
- identify the greatness of agriculture and learn to respect farmers.
- identify and explain possibilities of modern agricultural practices.
- identify the significance of indigenous varieties and engage in activities to protect them.
- implement and propagate agricultural practices that are harmless to the environment and health.



Let us assess

1. Cuniculture is related to
 - a. Keeping of honey bees
 - b. Rearing of rabbits
 - c. Cultivation of fruits and vegetables
 - d. Rearing of fish
2. *High quality hybrid varieties provide high yield. Then, what is the need of native varieties?* Record your response to this statement.
3. Which is the most appropriate way to reduce crop loss due to pests?
 - a. Using high concentration pesticides
 - b. Protecting friendly pests.
 - c. Practicing integrated pest management
 - d. Applying organic pesticides only.
4. 'Lower price during higher yield'. Suggest a practical solution to overcome this crisis faced by farmers.



Extended activities

1. Plan and implement land paddy cultivation, vegetable cultivation, etc., in the school premises with the help of agricultural authorities and experienced farmers.
2. Prepare a magazine collecting information on the indigenous varieties of different crops.



Unit
4

Properties of Matter

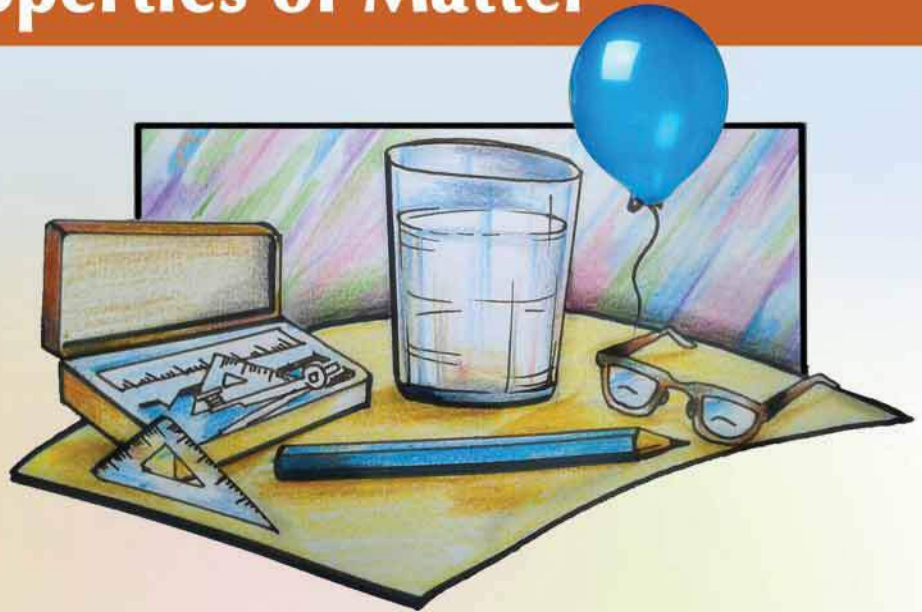

What are the objects seen in the picture?

What are the materials present in each object?

- Balloon : -----
- Pencil : -----

There are many objects of diverse nature around us. All these are made up of different materials. We are familiar with the physical states of materials. Which are the different physical states of materials seen around us?

-
-
-

Classify and tabulate the materials given in the picture on the basis of their physical states.

Solid	Liquid	Gas

Table 4.1

- What are the important properties of materials?

Let's find out through some activities.

Observe the figure. What are the things required to do the experiment shown in the figure?



Fig. 4.1

- How do we do this experiment?

Try to write down the procedure after observing Figure 4.1

- What happens to the water level when the stone is dipped in water? What is the reason?

Fill three-fourth of a trough with water. Keep a dry glass tumbler perpendicularly immersed in water in the trough (Figure 4.2).



Fig. 4.2

- What happens to the water level in the trough?

- Does water enter the tumbler?

- What material does the tumbler already contain?

- Is there a relationship between the volume of this material and the difference in the water level?

Isn't it clear that air requires space to occupy.

Hang two balloons filled with air at the two ends of a 30 cm long metal scale. Affix a piece of cellotape on one of the balloons. With the help of a thread, suspend the scale in a balanced position (Figure 4.3). Then, pierce the balloon with a needle on the cellotape.

- Record your observation.
- What do you infer from this?

From these experiments what inferences can be drawn about the properties of matter.

-
-

Matter is anything that occupies space and has mass.

We are familiar with materials in the solid, liquid and gaseous states.

- Which properties of the solids are you familiar with?

- What are the properties of liquids?

- Which of these properties are applicable to gases?

The properties related to the three states of matter are given below. Complete Table 4.2.

(Tick the appropriate ones).

Property	Solid	Liquid	Gas
Has mass			
Has definite volume			
Has permanent shape			

Table 4.2



Fig. 4.3



Plasma and other states

Matter is also found in states other than solid, liquid and gas. The fourth state of matter is Plasma. Matter is found in plasma state in the central part of the sun and other stars. Plasma is the state of matter in which the particles exist in ionized state at very high temperature.

The fifth and sixth states of matter are named Bose - Einstein Condensate and Fermionic Condensate respectively. Another state of matter is Super Fluid State. All these states can be generated in the laboratory only under special conditions.

Tiny particles in matter

Fill three fourth of a beaker with water. Put two or three crystals of potassium permanganate into it and stir well.

- What happened to potassium permanganate crystals?

- Can you see the crystals?

- Why the particles cannot be seen even though potassium permanganate is present in the solution?

It may therefore be inferred that each crystal of potassium permanganate is made up of crores of tiny particles.

Let's do another experiment.

Put some sugar in water and stirr.

Are the the sugar crystals visible? You can guess why?

Does this solution have the sweetness of sugar?

Aren't the dissolved tiny sugar particles that impart its property to the solution?

Each substance is made of tiny particles which cannot be seen with naked eyes. These particles bear all the properties of the substance.

Arrangement of particles in different states of matter

Note how some other characteristics of particles of substances in different physical states have been listed.

- particles have a distance between them.
- particles move continuously.
- particles attract one another.

The magnitude of these properties differ in various states.

Let's see how.

Observe the Figure 4.4.

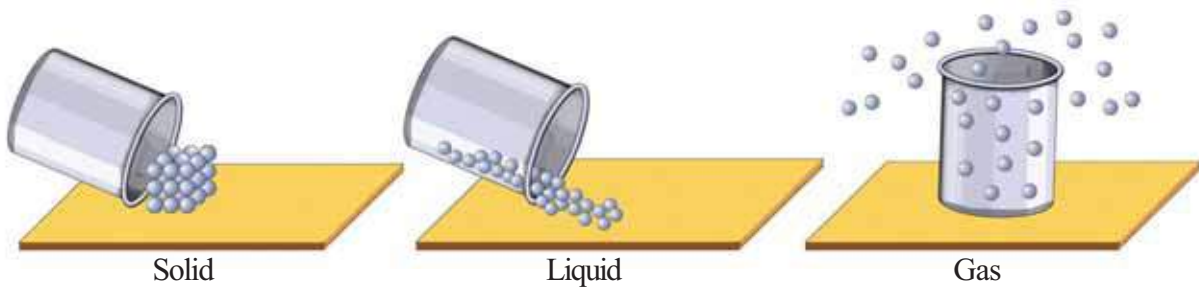

Fig. 4.4

- Is the arrangement of particles in the solid, liquid and gaseous states the same?
- In which of these states do particles remain very close to each other?
- In which of these states are the particles most distant apart?



See State of matter in PhET in IT @ School Edubuntu

Change of State

You must have studied that, when ice is heated, it changes into water and when water is further heated it boils and changes into steam. Similarly, change of state occurs to matter in all states.

Complete the flow chart given below.

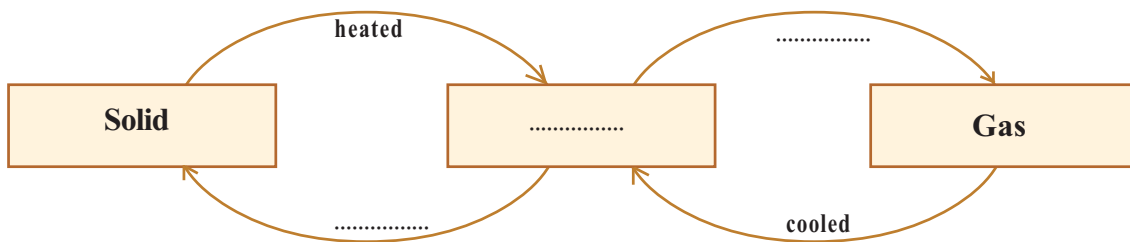

Which form of energy is responsible for the change of state here?

Observe the figure that depicts the movement of particles in solid, liquid and gas (Figure 4.5).

What are the changes that happen to the following properties when heat is absorbed?

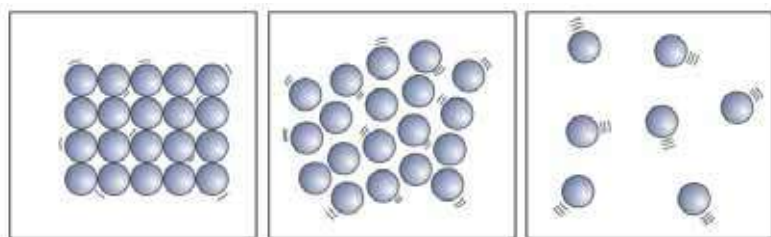

Fig. 4.5

- energy of particles :
- distance between particles :
- attraction between particles :
- movement of particles :

We convert solid into liquid and subsequently liquid into gas by supplying heat. If so, won't the particles of gas have higher energy than in the other two states?

- The particles of solid are very close to each other. Their freedom of movement is limited.
- In the liquid state, particles are relatively farther apart and have more freedom of movement than in the solid state.
- In the gaseous state, particles remain far away from one another. Their freedom of movement is very high.
- The difference in temperature causes the change of state.

In all states, when heat is provided, the energy and movement of particles increase, while attraction among particles decreases.

Some substances, when heated, change directly into gas without forming liquid. This phenomenon is **sublimation**.

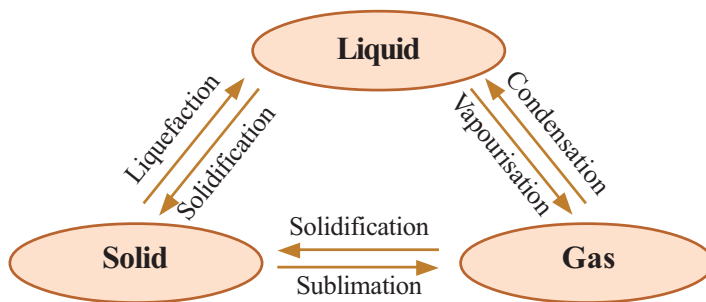

When the vapours of these substances are cooled, they change directly into the solid form. Naphthalene and iodine are examples for such substances.

Examine the given picture.

Analyse Table 4.3 given below and write down the changes during the transformation of states.

	When solid changes into liquid	When liquid changes into gas	When gas changes into liquid	When solid changes into gas
Movement of particles				
Distance between particles				
Attraction between particles				
Energy of particles				

Table 4.3

Diffusion of substances in different states

Let's look at another property of matter.

Iodine is a substance that is easily converted into gas on heating. Heat a few crystals of iodine in a watch glass. Collect the vapour

in a gas jar. Keep another gas jar on top of it in inverted position (Figure 4.6).

- Observe the colour of vapour.
- What change occurs in the colour of iodine vapours in the lower gas jar?

- What about the upper gas jar?

- What is the reason for this?

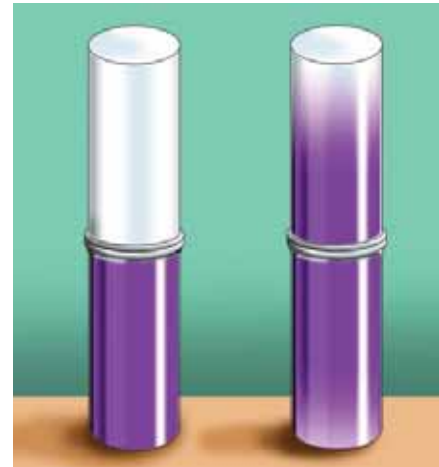

Fig. 4.6

An incense stick has fragrance. But the fragrance fills the room only when the stick is lit. Why do the fragrance spreads quickly in the room when the incense stick is lit?

Is there any relation between temperature and diffusion? Why does the smell of hot food spread quickly to a long distance?

Is the rates of diffusion of substances in gas and liquid the same?

Take water in a beaker, and add carefully a drop of red ink into it.

What do you see? Does the ink spread in the water?

Compare the diffusion of iodine vapour and ink and find the difference.

What is the relation between diffusion and movements of particles in different states?

In solids, is there a similar possibility for diffusion?

Place a drop of ink on a glass plate and observe.

Diffusion is the spontaneous mixing of different particles having freedom of movement

Find more examples for diffusion from daily life.

- Spreading of the smell of fruits.
-
-

Pure Substances and Mixtures

You are now familiar with the states of matter and the properties

of particles in these states. Each of the substances that we use are made up of tiny particles. Depending on their nature, substances can be classified into two.

1. Pure Substances
2. Mixtures

Molecules of water, common salt and gold have their own unique properties. Materials made of particles of identical nature are called **pure substances**. In saline water, both particles with properties of salt and water are present. The substances made of particles of different nature are called **mixtures**.

Classify the given materials into pure substances and mixtures.

Gold, soda water, soil, water, ice, water vapour, sugar, common salt, carbon dioxide, sugar solution and salt solution.

Pure Substance	Mixture
<ul style="list-style-type: none"> • Gold • • • • 	<ul style="list-style-type: none"> • Soda water • • • •

Table 4.4

Expand the table by including more substances you know.



See 'Padarthangalude Vargeekaranam' in School Resources in IT @ School Edubuntu.

Separating the Components of a Mixture

Most of the substances found in nature are mixtures. Eg:- soil, sea water, rock powder, sand, river water and air. Think about their components.

In daily life, we have occasions when components of mixtures are to be separated.

Look at a few instances where components of mixtures are to be separated: List out more of such instances.

- separating husk (chaff) from paddy.
- separating tea dreg from tea.
- separating common salt from sea water.
-

Complete the table given below:

Occasion / separation of	Method of separation	Property used for separation
• Tea dreg from tea	Filtration	Difference in the size of particles
• Common salt from sea water		
• Chaff from paddy		
• Iron powder from a mixture of iron powder and aluminium powder		

Table 4.5

The choice of the method of separation of components depends on the properties of the components of a mixture.

You know that common salt is separated from sea water by evaporation. Is this method sufficient if water is also to be obtained through separation? Here distillation can be used.

Distillation

Figure 4.7 depicts the method of distillation. Common salt solution is taken in the round bottomed flask. On heating the solution,

- Which component evaporates?
- Which substance will remain in the flask? What is the reason?
- What happens to the water vapour when it passes through the condenser?

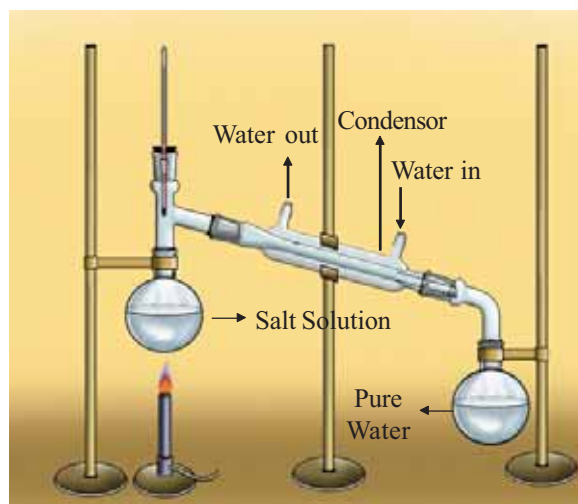

Fig. 4.7 Distillation

When one component of the mixture is volatile and the others do not vapourise under the same condition, they can be separated by distillation.

If the components of a mixture possess a large difference in their boiling points, they can be separated by distillation.

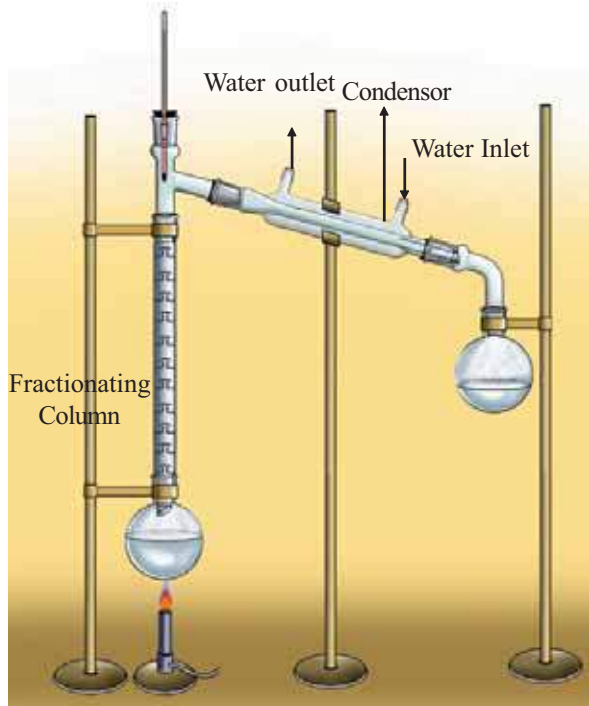

Fig. 4.8 Fractional Distillation

Fractional Distillation of Crude Oil

Crude oil which is drilled out from the depths of the earth is a mixture of hydrocarbons which do not have much difference in their boiling points. From this, petrol, diesel, kerosene, naphtha etc., are separated by fractional distillation.

Eg: Distillation can be used to separate a mixture of water (boiling point 100°C) and acetone (boiling point 56°C).

Ordinary water contains many minerals dissolved in it. The distilled water used for injection and in storage battery is produced by separating these minerals through distillation.

Fractional Distillation

If the boiling points of components have very small differences, fractional distillation is to be used to separate them. See Figure 4.8.

Ethanol (boiling point 78°C) and methanol (boiling point 65°C) are two miscible liquids. There is only a small difference in their boiling points. These two liquids are separated from their mixture by fractional distillation.

When vapours of the mixture pass through the fractionating column, repeated liquefaction and vapourisation take place. Subsequently, the vapours of low boiling methanol enter the condenser from the fractionating column, condense to liquid and get collected in the round bottomed flask first. Similarly, ethanol with higher boiling point can be collected later in another round bottomed flask.

Separation using Separating Funnel

Fill one-fourth of a bottle with kerosene. Pour equal amount of water into it, close the bottle and shake well. Keep it aside for a few minutes and observe.

What do you observe?

What is the reason?

Which liquid is seen at the bottom? Why?

Can you suggest a method to separate kerosene and water from this mixture?

Separating funnel is an apparatus used for separating immiscible liquids from their mixture.

Look at the picture showing the separation of liquid mixture with the help of a separating funnel. (Fig. 4.9)

Sublimation

Hope you remember collecting iodine vapour by heating iodine crystals. Iodine is a substance that changes directly into gas on heating without changing into liquid.

Which other substances show the same property?

Take naphthalene, camphor and ammonium chloride in separate test tubes. Heat them and observe. Do they melt into liquid? The process in which a solid, when heated, changes directly into gas without melting into liquid is called **sublimation**. This method can be used to separate the components which have the property of sublimation from the mixture.

Look at the given picture (Figure 4.10) showing the arrangement for separating the components of a mixture of ammonium chloride and sand. Observe the picture and write down the procedure. How did you obtain pure ammonium chloride?

Centrifugation

This is a method for separating components from a mixture, based on the difference in the mass of particles. This method is used in clinical laboratories to separate blood cells from blood samples and also for the quick separation of the precipitate obtained during chemical experiments. The liquid containing the sample is taken in a test tube and is rotated about a central point in the instrument. The particles with higher mass then get separated, away from the centre and those with lower mass remain closer to the centre.

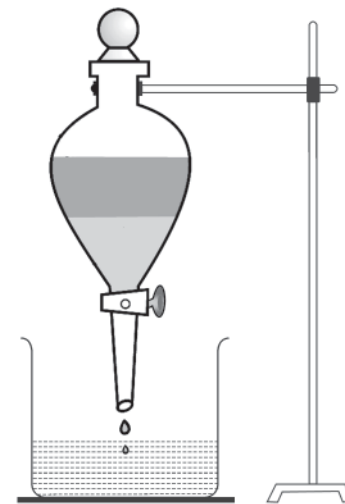

Fig. 4.9
Separating Funnel

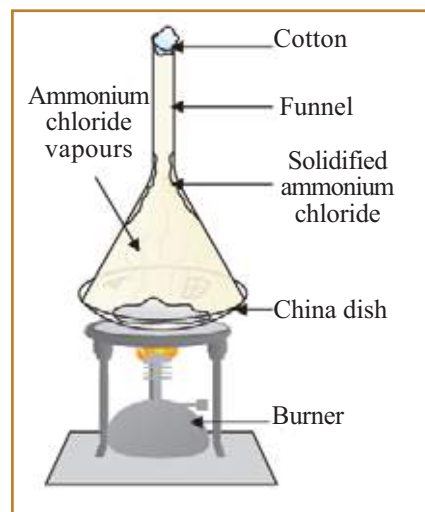

Fig. 4.10 Sublimation of ammonium chloride



Centrifuge
Fig. 4.11



When the centrifuge rotates

In order to separate insoluble particles in a liquid mixture on the basis of their mass difference, Centrifuge (Figure 4.11) is used. The process is known as centrifugation.

This method is used for separating butter from curd.

Chromatography

Put a black spot using a sketch pen on one end of a filter paper cut like a ribbon. Keep this dipped in the water in a beaker as shown in Figure 4.12 (a).

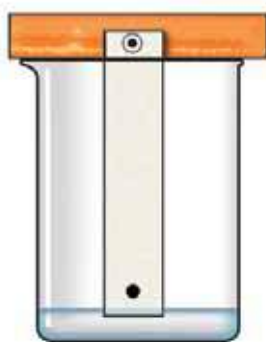

Fig. 4.12 (a)

- What can be observed when the water level in the filter paper ascends?
- What can be inferred from the different colours found in the filter paper?

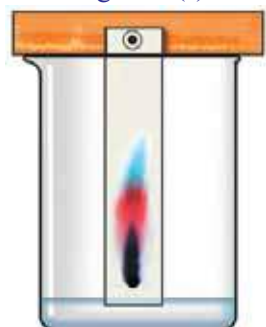

Fig. 4.12 (b)

This method of separating components of a mixture is known as Chromatography.

Chromatography is the method used to separate more than one solute dissolved in the same solvent. This method was first employed for separating coloured substances and hence this process came to be known as Chromatography.

Look at some of the occasions where chromatography is employed.

- to separate components from dyes.
- to separate poisonous substances mixed with blood.

Hope you are now familiar with some of the methods of separating components from a mixture. The components of a mixture will have to be separated by employing the above methods as well as by some other modern techniques. You will learn them in higher classes.



Adsorption-The basis of Chromatography

Capillarity is the phenomenon by which liquids rise through micropores against gravitation. The solute particles move along with the solvent which rises through the micropores in the filter paper. Due to the attraction between the filter paper and solute particles they get attached to the surface of the filter paper. This is called adsorption. Particles are separated on the surface of filter paper on the basis of the difference in the rate of adsorption.



Significant learning outcomes

The learner can

- explain the peculiarities of materials.
- classify materials by identifying the different states of matter and their characteristic properties.
- identify and picturise the arrangement of particles in different states of matter.
- explain the property of diffusion in liquid and gaseous states, and make use of it in daily life.
- distinguish pure substances and mixtures and tabulate them.
- separate components of a mixture on the basis of their characteristic properties.
- explain the various methods used for separating components from mixtures and make use of them in daily life.



Let us assess

1. A few mixtures are given below. Tabulate the methods to separate their components and give the reasons for selecting the method.

Mixture	Method	Reason
Common salt and ammonium chloride		
Sugar solution		
Petrol and Kerosene		
Camphor and glass powder		
Iron powder and sand		

2. Given below are certain changes taking place to the particles during change of state. From this, find out and tabulate the changes in the particles when water boils to form steam and also when steam condenses to form water.
 - distance increases
 - attractive force decreases
 - energy increases

- rate of movement increases
 - distance decreases
 - energy decreases
 - attractive force increases
 - rate of movement decreases
3. Spirit kept open in a watch glass disappears after some time. Which among the following phenomena are responsible for this?
- a) sublimation b) distillation
c) evaporation c) diffusion
4. Which are the methods that can be used to separate the components of a mixture made of common salt, ammonium chloride and sand?
Write the methods in the order in which they are applied.
5. Many minerals are present in ordinary water.
- a) Which is the method that can be used to remove the minerals and obtain pure water?
b) In which type of mixtures is this method employed?
c) Water purified by this method is distilled water. Write two instances of its use.
6. From the following statements, tick (✓) those which apply to solid substances alone.
- Particles have little freedom of movement.
 Distance between particles is very high
 Particles remain very close to each other
 Energy of particles is very high



Extended activities

1. Take a small wooden rectangular block and find its volume. (volume = length x breadth x height).
Take a big measuring jar and fill three-fourth of it with water and mark the water level. Then dip the block in water in the jar. (To prevent floating, nails can be inserted in the block). Mark the difference in the water level.
- a) Is there any relation between the difference in the water level and the volume of the block?

- b) Which property of matter is revealed by this experiment?
2. Electronic balances are very popular now. On an electronic balance, find the weight of an empty balloon. Again, find its weight after filling air. Now, can you find the weight of the air in the balloon?
- Repeat the experiment using balloons of different size by filling them with varying quantity of air.
3. Take water mixed with chalk powder in a bottle. Tie a string to the bottle and swirl it at high speed along a circular path. Observe after sometime.
- Repeat the activity using other mixtures which are suspensions. To which method of separation of components of a mixture can this be connected? Are there instances where this principle is made use of. Prepare a note.
4. Take a long white chalk piece and put a mark with black ink slightly above the bottom. Keep the chalk piece dipped perpendicularly in water in a watch glass. After some time observe the changes. Repeat the experiment using different chalk pieces marked with sketch pens of different colours. To which of the methods of separation you have studied is this related?



Unit
5

Basic Constituents of Matter



The earth in which we live is rich in diverse substances. Most of these substances which occur in different physical states, are mixtures and a few others are pure substances. Classify the substances familiar to you into mixtures and pure substances. Do you see such substances in the above picture? How are these substances produced?

Break a piece of sugar candy. Break the pieces thus obtained, again into smaller pieces. Have you ever thought how small the particles can be made into by breaking it?

Sugar candy, potassium permanganate, gold, silver, etc., are pure substances. You know that the particles in sugar candy and potassium permanganate solutions cannot be seen as they are extremely small.

Now, let's carry out an experiment.

Take one or two pieces of camphor in a china dish. Heat the china dish slowly. What do we observe?

- What kind of change occurs to camphor?
- Do you get the smell?

Doesn't the smell linger even after the camphor has disappeared completely? Here also, the particles of camphor are not visible. Now can't you infer that camphor has spread in air as extremely small particles.

Isn't it the same that happens when water taken in a watch glass evaporates?

It may therefore be learnt that all the substances like sugar candy, potassium permanganate, water and camphor are made of minute particles.

Similarly, pure substances like gold, silver etc., are also made of extremely small particles.

Can pure substances be further decomposed?

Fill one quarter of a boiling tube with sugar and close it with cotton. Then heat the boiling tube strongly (Figure 5.1). What can be observed? What is seen on the sides of the boiling tube?



Fig. 5.1
Heating of sugar

•
•
What are the substances obtained by heating sugar?



Sir Humphry Davy
(1778 - 1829)

Now you know that carbon and water are the components of sugar. Carbon obtained by heating sugar cannot be further divided. But, in 1806 Sir Humphry Davy discovered that when electricity is passed through water it splits into hydrogen and oxygen. In fact, Davy's finding was made possible by the discovery of Henry Cavendish that hydrogen burns in oxygen to give water. Sugar, a pure substance can be further divided into carbon, hydrogen and oxygen. Similarly, another pure substance, water can be divided into hydrogen and oxygen. At the same time, pure substances like carbon, hydrogen, oxygen, gold and silver cannot be further divided into its components by chemical reactions.

Elements and Compounds

Don't you now realise that pure substances are of two kinds? Of these, **the pure substances which cannot be further decomposed through chemical processes are called elements.** Find more examples of elements and list them.

- Hydrogen
-

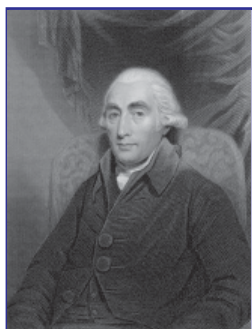

Henry Cavendish
(1731 - 1810)

Compounds are pure substances formed from two or more elements through chemical combination. Compounds can be converted into its constituent elements through suitable chemical processes. Find more examples for compounds and note them in the science diary.

- Water
- Sugar
-
-

Elements are pure substances which cannot be split into simpler components through chemical processes. Compounds are substances formed by the combination of two or more elements through chemical reactions.



Berzelius

In early days, pictures were used as the symbols of elements. The modern method of assigning symbols was developed by the Swedish scientist Berzelius.

Berzelius also discovered the elements Selenium, Thorium, Cerium and Silicon.



Berzelius
(1779-1848)

Origin of the names of elements

Have you ever thought how each element got its name?

In the past, the elements were named after places, countries, continents, characteristic properties, scientists, planets, satellites etc.

Note some of the examples given below.

Element	The basis of naming		
Polonium	Poland	-	Country
Curium	Marie Curie	-	Scientist
Chromium	Chrome	-	Colour
Indium	Indigo	-	Colour
Chlorine	Chloro	-	Colour
Neptunium	Neptune	-	Planet
Europium	Europe	-	Continent

Table 5.1

Find the basis for giving names to the elements in the Table given below, and complete the table.

Element	The basis of naming
Americium
Francium
Rubidium
Plutonium
Titanium
Mendelevium
Rutherfordium

Table 5.2



See kalziumold in IT @ School Edubuntu, for finding out how elements got their names.

Symbols

Symbols are used for representing elements. Symbols are assigned to elements in different ways.

Look at the examples given.

Elements	Symbol
Carbon	C
Oxygen	O
Nitrogen	N
Hydrogen	H
Sulphur	S

Table 5.3

The first letter of the English name is used as the symbol for the elements in the table. The capital letters are used as the symbols. But, for some elements, along with the first letter, the second or another prominent letter is also used in the symbol as a small letter.

Elements	Symbol
Calcium	Ca
Chlorine	Cl
Chromium	Cr
Bromine	Br
Beryllium	Be

Table 5.4

The symbols of some elements have been derived from their Latin names. Look at the examples.

Elements	Latin name	Symbol
Sodium	Natrium	Na
Potassium	Kalium	K
Copper	Cuprum	Cu
Iron	Ferrum	Fe

Table 5.5



See the part
'Moolakangal' in
School Resources in
IT@ School Edubuntu.

The periodic table of elements is given in the picture (Figure 5.2)
(See page 159 for the Periodic Table).

Periodic Table

Gases
 Liquids
 Synthetic Elements

Atomic Number
Symbol
Malayalam Name
English Name
Latin/ Greek name

Fig. 5.2

Analyzing the periodic table, find out the following.

- The elements familiar to you.
- The elements which you have actually seen.
- The elements which are more useful in our daily life.
- List separately some elements which exist in solid, liquid and gaseous states.



See 'Gperiodic' in IT @ School Edubuntu

Atom and Molecule

Let us see which is the smallest particle of an element. The element carbon is made up of extremely small particles. Think of breaking a piece of carbon into smaller and smaller particles. When it is broken up in this manner, we get the smallest particle which retains all the characteristic properties of carbon at the end. This smallest particle is called an atom of carbon. The other elements are also made up of their atoms.

Atom is the smallest particle which shows all the characteristic properties of an element.

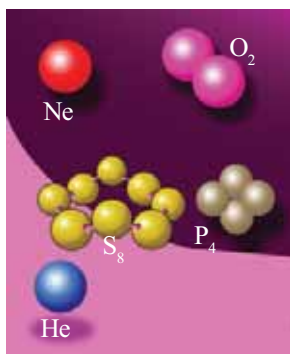

Fig. 5.3
Molecules of element

Atoms of some gaseous elements like helium, neon etc., can exist as free single atoms. But atoms of some other gaseous elements like hydrogen, oxygen etc., can exist only as a combination of two atoms. Atoms of some elements are seen to exist as a

combination of more than two atoms (Figure 5.3). The smallest particles which can exist independently are called molecules. Like elements, compounds also have molecules. Molecules of compounds consist of atoms of two or more different elements.

Molecules are the smallest particles which can exist independently.

Method of representing Atoms and Molecules

You have studied the method of assigning symbols for the elements. Now, let us see how the atoms and molecules are represented.

The symbol of helium is 'He'. When we write 'He', it represents one atom of the element helium. What does 2He represent?

Elements like helium, neon, argon etc., are seen in nature as single atoms. They are monoatomic molecules. Their molecules can also be represented as He, Ne, Ar etc. But elements like hydrogen exist as diatomic molecules. Hydrogen atom is represented as H, and how about its molecule?

H_2 represents a hydrogen molecule.

Some elements exist as molecules of more than two atoms. Phosphorus (P_4), sulphur (S_8) etc., are examples of such elements.

Molecules with only one atom are called monoatomic molecules. Those with two atoms each are called diatomic and molecules with more than two atoms are called polyatomic molecules.

In monoatomic molecules, the number given on the left side of the symbol indicates the number of molecules and atoms. In polyatomic molecules, the subscript on the right side of the symbol indicates the number of atoms within one molecule. The total number of molecules is indicated on the left side.

Classify the following molecules into monoatomic, diatomic and polyatomic.



The size of Atom

Can you imagine the size of an atom? The word, 'atom' has been derived from the Latin word, Atomos. It means something indivisible. The diameter of a gold atom is 0.000000254 cm, which means around 3.5 crores gold atoms arranged in a row would be as long as just 1cm. Ancient Indian thinker Kanadan and Greek thinker Democritus have talked about the smallest particles of substances centuries ago. It was John Dalton, an English Scientist who formulated the modern theory of atom.

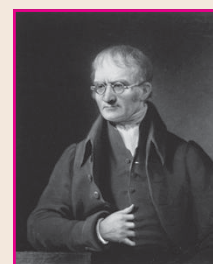

John Dalton (1766-1844)

Monoatomic	Diatomic	Polyatomic

Table 5.6

In the table given below, write the number of molecules and the total number of atoms.

Substance	Number of molecules	Total number of atoms
O ₂		
2N ₂		
6Cl ₂		
2He		
5Na		
O ₃		
P ₄		

Table 5.7

Compounds

We have seen how molecules are formed from the same type of atoms. Millions of English words are formed from the letters of the English alphabet. Similarly, the compounds contain molecules formed from atoms of different elements (Figure 5.4).

Compound Molecules and Atoms	
Molecules	Atoms present
Carbon dioxide	Carbon, Oxygen
Hydrogen chloride	Hydrogen, Chlorine
Water
Sugar
Mercuric oxide	Mercury, Oxygen

Table 5.8

Carbon dioxide is a compound. Carbon dioxide is formed when carbon burns in oxygen. Carbon dioxide is also formed by the decomposition of calcium carbonate.

Whatever be the source of a compound, a fixed ratio is maintained between the atoms of the different elements present in it. In carbon

dioxide molecule, the ratio of carbon atoms to oxygen atoms is always 1 : 2. Thus carbon dioxide molecule can be represented as CO_2 . This type of representation is known as **the chemical formula** of the compound.

The table shows some molecules and the atoms present in them. Try to find more examples.

Molecule	Atoms present	Chemical formula
Carbon dioxide	Carbon - 1 Oxygen - 2	CO_2
Water	Hydrogen - 2 Oxygen - 1	H_2O

Table 5.9

- The chemical formula of sulphuric acid is H_2SO_4 . How many hydrogen atoms are present in one molecule of sulphuric acid?

- How many sulphur atoms are present? How about oxygen atoms?

- Altogether, how many atoms are present?

What if it is $2\text{H}_2\text{SO}_4$?

Determine the total number of atoms present in the molecules given below.

- CO_2
- $5\text{H}_2\text{O}$
- 7NH_3
- $2\text{C}_{12}\text{H}_{22}\text{O}_{11}$
- 3NaCl
- ZnCl_2

Chemical Equations

Write the symbol of the element, zinc. -----

What is the chemical formula of hydrochloric acid?

You have seen earlier the reaction between hydrochloric acid and zinc. What are formed as a result of this reaction?

*The substances taking part in a chemical reaction are called the **reactants**. Substances formed as a result of the reaction are called the **products**.*

Note down the reactants and the products in the reaction given above.

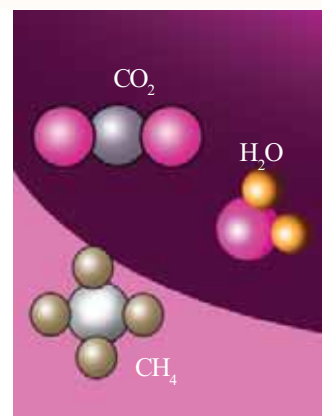

Models of carbon dioxide, water and methane molecules. Fig. 5.4 (a)

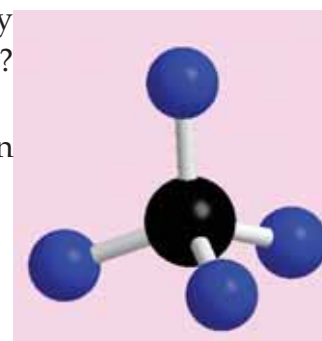

Ball and stick model of methane (CH_4) Fig. 5.4 (b)



Different molecular models can be produced using chemical in IT @ schoolEdubuntu.

Reactants :

Products :

The chemical reactions can be represented as equations containing the symbols and chemical formulae of the reactants and the products. If so, can the above reaction be represented as

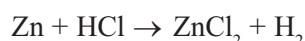

Now, see how the number of atoms on both sides of the arrow has been tabulated.

Atom	The number of atoms	
	Reactants	Products
Zn	1	1
H	1	2
Cl	1	2

Table 5.10

Is the number of atoms on both sides of the arrow equal?

The number of identical atoms should be equal on both sides of the arrow. So let us re-write the equation as follows:



Examine the number of atoms in this equation.

Atom	The number of atoms	
	Reactants	Products
Zn	1	1
H	2	2
Cl	2	2

Table 5.11

Now, isn't the number of atoms of the same kind on both sides of the arrow equal?

*When a chemical equation is written, the number of atoms of the same kind, on the side of reactants and that of products should be equal. This type of chemical equations are called **balanced chemical equations**.*

Now, look at the balanced chemical equations given below. Write down the reactants and products in the table.

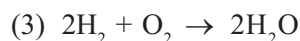
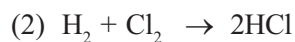
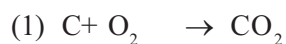

No.	Reactants	Products
1		
2		
3		

Table 5.12

The equations given below are not balanced. Can you balance them?

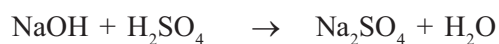
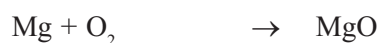

Write down the equations for the chemical reactions familiar to you and try to balance them. You will learn more chemical reactions and chemical equations in higher classes.



Significant learning outcomes

The learner can

- distinguish between elements and compounds.
- identify the symbols of different elements.
- list the atoms present in the molecules of elements and compounds.
- formulate the symbols for different elements.
- write the chemical formulae of different compounds.
- write and balance the equations for chemical changes.



Let us assess

- Classify the following into elements and compounds.
Ammonia, sugar, nitrogen, mercury, sodium chloride, water, copper sulphate, sodium, carbon.
- Analyse the chemical equation given for the reaction between nitrogen and hydrogen to give ammonia.

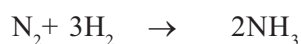

- What are the reactants and products in this reaction?
 - Find the total number of molecules and atoms of the reactants.
 - Find the total number of molecules and atoms of the products.
 - What is the relation between the number of atoms of the reactants and products?
- N is the symbol of nitrogen.
 - What do N_2 , 2N and 2N_2 indicate?
 - How many molecules and atoms are present in 5N_2 ?
 - Some chemical equations are given.

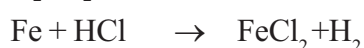
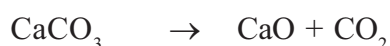
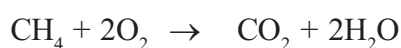

- Which of these are balanced chemical equations?
 - Balance those equations which are not balanced.
- Find whether the following statements are right or wrong.
 - All atoms of the same element show the same properties.
 - The atoms present in a compound are different.
 - Elements are pure substances.
 - Hydrogen is a monoatomic molecule.



Extended Activities

- Take iron powder and sulphur powder in their mass ratio of 7:4 in a china dish. Heat it strongly for some time.
 - Try to separate the iron powder using a magnet. What can be observed? What is the reason?
 - Add a little dilute hydrochloric acid to the above product; observe the changes taking place, and write them down.
 - Write down the inferences you have arrived at from these observations.
- Make and exhibit the models of the following molecules using ball and sticks, different fruits and splints.
 - Water (H_2O)
 - Ammonia (NH_3)
 - Carbon dioxide (CO_2)
 - Methane (CH_4)
- Haven't you understood how symbols are assigned to elements? Given below are some elements that received symbols from their Latin names. Complete the table with the help of the Periodic Table.

Element	Latin name	Symbol
Silver
.....	Hydrargium
Tin
.....	Pb
Antimony
.....	Aurum



Unit
6

Chemical Changes

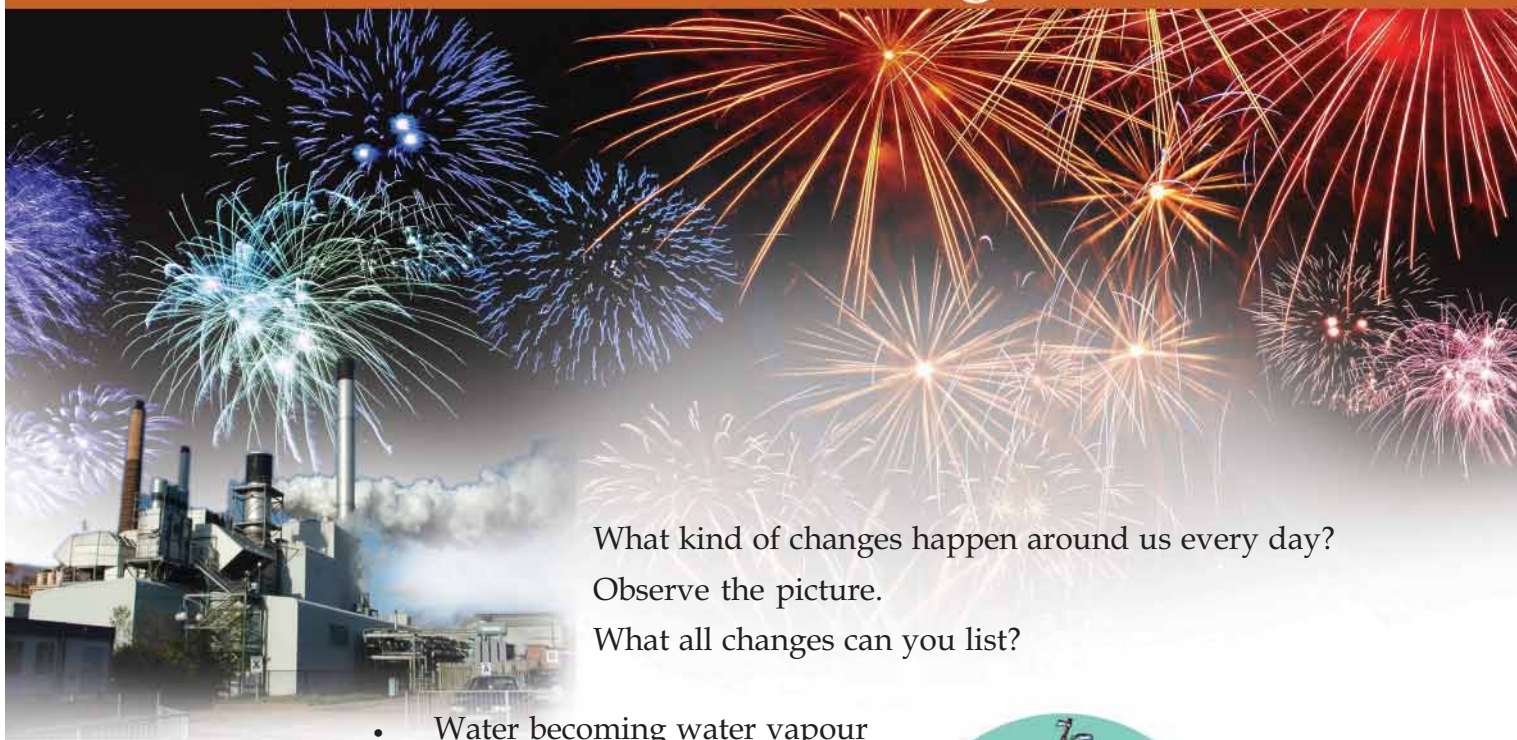

What kind of changes happen around us every day?
Observe the picture.
What all changes can you list?

- Water becoming water vapour
- Burning of wood
- Rusting of iron
- Melting of wax
- Explosion of crackers
- Cutting of wood
-
-



Fig. 6.1

Classify the above into physical changes and chemical changes.

Physical change	Chemical change

Table 6.1

Think about the differences between the two types of changes given in the table. In physical changes, only the arrangement of molecules within the substance changes. This is a temporary change. But in a chemical change, one substance gets completely transformed into a new substance. That is, new molecules are formed. This is a permanent change.

During a physical change, only a change in the arrangement of molecules occurs. Hence it can be easily brought back to its original state. In the case of chemical changes, new molecules are formed.

Let us familiarise ourselves with a few more chemical changes. Take two beakers and fill three-fourth of them with water. Drop a small piece of sodium in one beaker. Notice the formation of a gas by the vigorous reaction between sodium and water. After the reaction, add two drops of phenolphthalein in both the beakers. What do you observe?

The presence of which substance is indicated by the colour change in the beaker to which sodium was added?

The alkali formed by the reaction of sodium with water is sodium hydroxide. Metals like sodium and potassium react vigorously with water to form hydrogen gas and the corresponding alkali. Write the reactants and products involved in the above reaction.

Reactants

Products

Write down the balanced chemical equation of this reaction.

You know that heat and light are produced when magnesium burns in air. Let us consider a few other chemical changes.



Fig. 6.2



Fig. 6.3

Thermo chemical reactions

Add 5 mL dilute hydrochloric acid to a piece of magnesium taken in a test tube.

- Which is the gas liberated in this reaction?
- Touch the bottom of the test tube. What do you feel?

Why does the test tube get warm?

Heat was evolved along with formation of the products.

The balanced chemical equation of this reaction is as follows:

Magnesium + Hydrochloric acid → Magnesium chloride + Hydrogen + heat



Flaring up a glowing incense stick

Take a few crystals of potassium permanganate in a dry test tube. Heat the test tube. Bring a glowing incense stick to the mouth of the test tube. What do you observe?

The stick flares up. What could be the reason?

- Does the residue in the test tube have the colour of potassium permanganate?

Can this reaction take place without heating? Try.

When potassium permanganate is heated, it decomposes to form potassium manganate, manganese dioxide and oxygen.

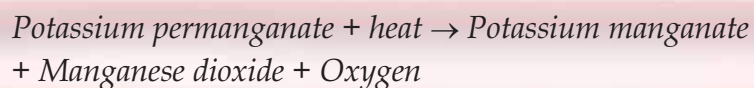

In this reaction, potassium permanganate decomposes with absorption of heat.

Add hydrochloric acid to a concentrated solution of sodium hydroxide taken in a test tube. As the reaction proceeds, does the test tube become hot or cold?

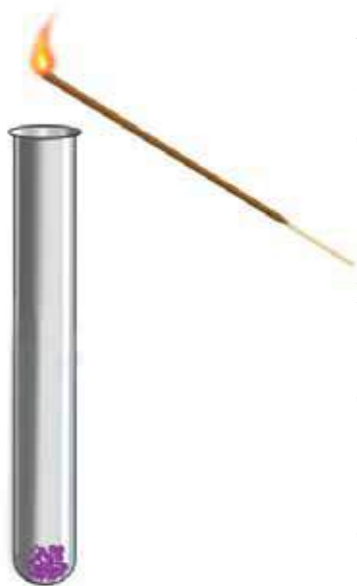

Fig. 6.4

- What kind of chemical reaction is the neutralisation reaction between sodium hydroxide and hydrochloric acid?

Heat absorbing/Heat liberating

Find more examples of reactions from daily life which involves the absorption or liberation of heat and record them in your science diary.

Chemical reactions which liberate heat are called exothermic reactions and those which absorb heat are called endothermic reactions.

Photochemical reactions

Photosynthesis is a chemical reaction that is responsible for sustaining life on earth. In this reaction, plants produce glucose by absorbing light. Note the chemical equation of this reaction.

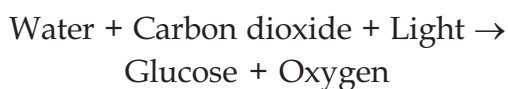

The glucose thus formed is stored by plants in the form of starch.



Photosynthesis: An important chemical reaction in the biosphere

Green plants are highly essential for sustaining life on earth. Leaves are the food factories of nature. In the presence of sunlight, chlorophyll in plants prepare glucose using carbon dioxide and water. This glucose is converted to starch and stored in the leaves, fruits and tubers of plants. Green plants alone can prepare glucose in this manner.



Glow of a fire fly



Light produced by a fire fly is the result of a chemical reaction that happens in its body. Light energy is emitted as a result of the formation of oxyluciferin through the reaction between luciferin and oxygen in the presence of luciferase, an enzyme present in the **fire fly's body**. This phenomenon is known as **bioluminescence**. 95% of the energy liberated in this process is in the form of light. This is the reason why heat is not felt when a fire fly glows.

Salt that turns black in sunlight

Take some silver bromide in two dry watch glasses. Wrap one of them with a black paper. Keep both of them in sunlight for some time.

- What do you observe?
- In which watch glass does the colour of silver bromide change?
- Which form of energy was responsible for this chemical change?

This was due to the deposition of silver produced as a result of the decomposition of silver bromide by the absorption of light.

What could be the reason for storing certain medicines and chemicals in brown bottles? Think of it.

Chemical reactions which liberate or absorb light energy are known as **photochemical reactions**.

Electrochemical reactions

Let us do an experiment.

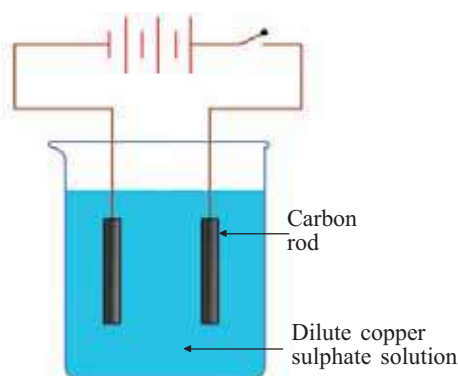

Fig. 6.5

Set up the apparatus as shown in Figure 6.5. What changes do you observe when electricity is passed through the circuit?

- In the colour of copper sulphate solution:

- On the carbon rods :

The change in colour of copper sulphate solution and the deposition of copper at the electrode proves that a chemical change has occurred.

- Does it happen if a carbon rod is simply kept in copper sulphate solution?
- Which form of energy was responsible for this chemical change? Was the energy liberated or absorbed?

In this reaction, copper sulphate decomposed with the absorption of electrical energy. The process in which a substance undergoes



Electrolytes

Electrolytes are substances which undergo chemical change when electricity is passed through them. Sodium chloride, copper sulphate, silver nitrate etc., are electrolytes. Acids, alkalis and salts in their molten form as well as in aqueous solutions are electrolytes. The rods which are connected to the poles of a battery and which transfer electricity to the electrolyte are known as electrodes.

decomposition by the absorption of electrical energy is known as **electrolysis**.

Set up the apparatus as shown in Figure 6.6.

Why does the LED glow when the switch is turned on? How is this form of energy produced?

Here, electricity is produced as a result of a chemical reaction between the acid and the metals kept immersed in it. Such arrangements which produce electricity as a result of chemical reaction are known as **Electrochemical cells**.

A battery made of lemons

Take a few lemons and in each one of them, fix a copper rod and a zinc strip. As shown in Figure 6.7, connect the zinc strip of one lemon to the copper rod

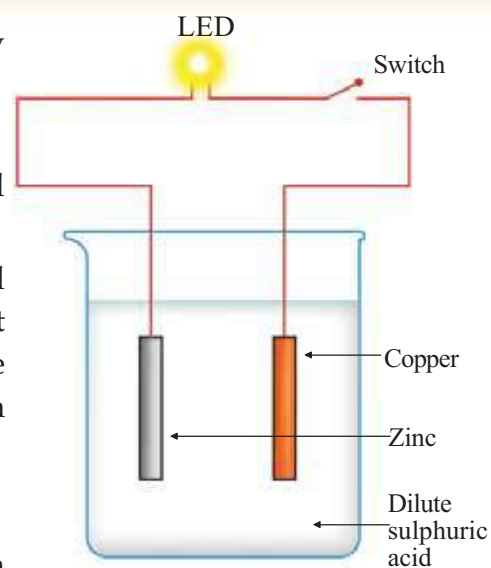

Fig. 6.6

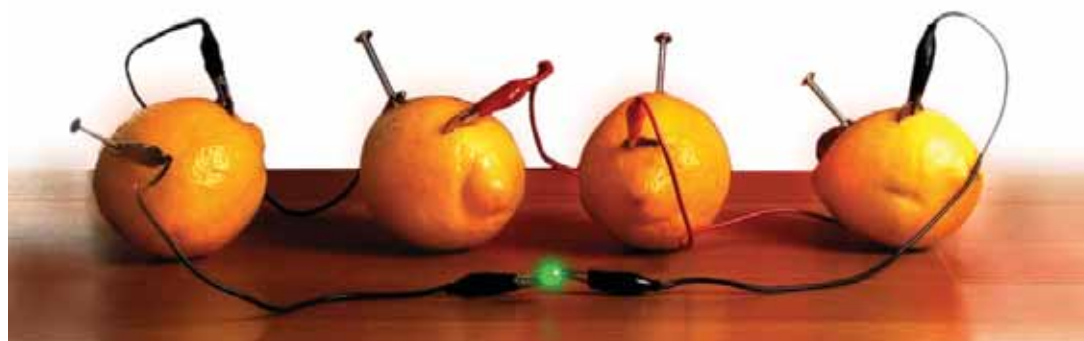

Fig. 6.7

of the next lemon. Connect the copper rod on the first lemon and the zinc strip on the last lemon to an LED using a conducting wire. The LED glows. What is the reason?

You know that lemon and many other fruits contain acids. Electricity is produced here by the reaction of these acids with metals.

Try to make cells using a variety of fruits and different metals. Chemical reactions in which electrical energy is consumed or produced are known as **electrochemical reactions**.

Electroplating

You are familiar with the gold plated ornaments that are available in the market. Electricity is used to obtain a thin coating of a particular metal on other metallic objects. This process is

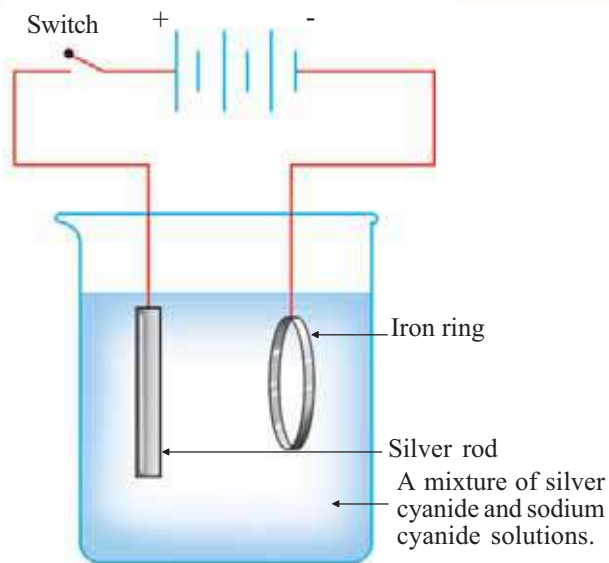

Fig. 6.8

known as electroplating. Electroplating is an electrochemical reaction.

Observe the figure which shows the arrangement of coating silver on an iron ring (Figure 6.8).

The silver rod and the iron ring are connected to the battery as shown in the figure. When switched on, the iron ring gets covered with a thin layer of silver metal. If copper is to be coated, copper sulphate solution and a copper rod instead of silver rod should be used.

Now, you might have understood that

forms of energy like heat, light and electricity are exchanged during chemical reactions. There are chemical reactions which involve the absorption or liberation of energy. Those which absorb energy are known as **endoergic** reactions and those which liberate energy are known as **exoergic reactions**.

List the energy involved in the chemical reactions discussed above and record them in your science diary.

Chemical change	Major energy change
<ul style="list-style-type: none"> Reaction between magnesium and hydrochloric acid 	<ul style="list-style-type: none"> Heat energy is liberated

Table 6.2



See 'Vaidyuthalepanam' in School Resources in IT@School Edubuntu

Energy transfer occurs during any chemical reaction. A chemical reaction will be known based on the major energy form which gets absorbed or liberated.

Identify and tabulate the class of chemical reactions with which you have already familiarised yourselves.

Reaction	Name of chemical reaction
<ul style="list-style-type: none"> Heating potassium permanganate 	<ul style="list-style-type: none"> Exothermic reaction

Table 6.3

Different types of cells

Cells are widely used sources of electrical energy. Electricity is produced in them through chemical reactions. Figure 6.9 shows various types of cells that we generally use. Observe and understand their uses from the table.



Fig. 6.9

Cell	Instrument in which it is used
Dry cell	<ul style="list-style-type: none"> • Radios • Cameras • Clocks • Toys
Mercury cell	<ul style="list-style-type: none"> • Watches • Calculators • Electronic instruments •
Nickel-cadmium cell	<ul style="list-style-type: none"> • Rechargeable torches • Cameras • •
Lithium ion cell	<ul style="list-style-type: none"> • Mobile phone • Laptops

Table 6.4

- What do we do with these types of cells after their use?
- Which among these cells can be recharged and reused?
- Do they cause environmental pollution?

Prepare a note and present it.

Environment friendly changes

Many natural and manmade chemical changes happen around us. All of them need not be environment friendly, especially the chemical reactions carried out in factories. Nature tries its best to adapt itself to these changes. But



Charged particles

Aqueous solutions of salts, acids and alkalis contain positively (+) charged particles and negatively (-) charged particles. This is why they are set free at the negative (-) and positive electrodes (+) respectively during electrochemical reactions. See the chemical formula of such particles in the list given in the table. Such particles are known as ions.

Observe the list of some ions

Positive ion		Negative ion	
Sodium	Na ⁺	Chloride	Cl ⁻
Potassium	K ⁺	Carbonate	CO ₃ ²⁻
Zinc	Zn ²⁺	Sulphate	SO ₄ ²⁻
Magnesium	Mg ²⁺	Nitrate	NO ₃ ⁻
Calcium	Ca ²⁺	Oxide	O ²⁻
Copper	Cu ²⁺	Bicarbonate	HCO ₃ ⁻

The chemical formula of the compounds formed by the ions can be obtained, depending on the charges possessed by the ions. You will study more about this in higher classes.

beyond a certain limit, even biological wastes destroy the harmony of nature. Then you can imagine how worse would be the situation caused by factory wastes. Hence, accumulation of those materials, which cannot be biodegraded may become a threat even to the existence of life itself.

For the sake of posterity, isn't it the duty of each one of us to protect the earth from getting polluted?

Hence there should be efforts to maximise the conversion of such non-decomposable and polluting materials to environment friendly materials. This should be one of the aims of studying science.

Try to arrange a seminar on this topic.



Significant learning outcomes

The learner can

- classify changes happening in nature into physical changes and chemical changes.
- classify chemical changes into thermochemical changes, photochemical changes and electrochemical changes.
- find examples for exothermic and endothermic reactions.
- use electrochemical cells judiciously.
- electroplate different objects.
- engage in activities to prevent environmental pollution.



Let us assess

1. Assess the chemical reactions given below and answer the questions.

Calcium carbonate + heat \rightarrow Calcium oxide + Carbon dioxide

Calcium oxide + water \rightarrow Calcium hydroxide + heat

- a) Mention the reactants and products in each case.
- b) Which among these is endothermic? Which one is exothermic?

2. Some chemical reactions are given below. Identify the energy change involved and write down what type of chemical reaction takes place here.
 - a) Burning of a candle
 - b) Glowing of a fire fly
 - c) Plating a copper ring with gold
 - d) Reaction between potassium hydroxide and sulphuric acid
 - e) Burning of fuels
3. A student tries to plate an iron nail with copper. Draw its arrangement by selecting the required materials from the list given below.
 Silver nitrate, iron nail, copper sulphate, silver rod, copper rod, silver plate, iron sulphate, battery, wire, water, beaker.
4. List out the instruments that use electrochemical cells. What are the merits and demerits of using such cells?
5. Classify the following into physical changes and chemical changes.
 1. Melting of ice.
 2. Heating magnesium in water.
 3. Silver bromide kept exposed to sunlight.
 4. Change happening to soda water on opening its bottle.
6. Give an example each for exothermic and endothermic reactions.



Extended activities

1. Making a volcano

Heap up some ammonium dichromate powder on a tile. Deposit on it the chemical present on a match stick, and ignite. Write down the changes happening there.

Change in colour :

Change in amount :

Exchange of energy :

2. Kindling fire by pouring oil.
Heap up some potassium permanganate on a tile. Keep a piece of dry cotton wick on top of it. Pour one or two drops of glycerine on the wick. Observe the changes.
3. Take a magnesium ribbon and clean it by scrubbing. Then burn it in air. Collect the product formed and dissolve it in water. Dip litmus papers and pH paper in this solution and observe. Find out the reason for the results of the observations.
4. Take sodium chloride solution in a beaker. Add to it a few drops of phenolphthalein. With the help of two carbon rods, let electricity pass through the solution. Record your observations. What is your inference?
5. Take some silver nitrate solution in a test tube and add some sodium chloride solution to it. What is the colour of the precipitate formed? Filter the precipitate using a filter paper, place it on a watch glass and keep it exposed to sunlight. What do you observe?

Try to write down the equation of your observation with the help of your teacher.

Identify the change of energy involved in the second chemical reaction and write down what type of chemical reaction it is.



Unit
7
Metals



All the objects in nature are made up of different types of substances. These substances are formed from different elements. Aren't you familiar with the arrangement of elements in the periodic table? Try to list from the periodic table some of the elements that are familiar to you.

- Hydrogen
- Iron
- Gold
-
-

Are there metals in this list? Which are they?

You may be able to identify some uses of metals when you observe the picture given at the beginning. Don't you think that these uses are possible due to certain special properties of metals?



Fig. 7.1 (a)

How do you know whether an object is made of metal?

- By testing its hardness
- By heating
-

General characteristics of metals

Which of the characteristics of metals are you familiar with? The table given below lists some metals. Complete the table by listing their characteristics as well as the objects which make use of those characteristics.



Fig. 7.1 (b)

Metal	Property	Objects
Gold	Lustrous, Resistant to corrosion	Ornaments
Copper		
Iron		
Aluminium		

Table 7.1



Fig. 7.1 (c)

With a hammer, beat forcefully on an aluminium wire kept on a hard surface. What do you see?

Haven't you noticed aluminium foils used to wrap chocolates and sweets? Which property of the metal is utilised here?

Metals can be beaten into thin sheets by hammering. This property is known as malleability.

Gold is the most malleable metal.

Try to find more instances where malleability of metals is employed.



Gold is the most malleable metal

One gram of gold can be beaten into sheets with an area of about 6.7 square feet and can be drawn into a wire of about 2 km in length.

Ductility is another useful property of metals.

Metals can be drawn into thin fine wires. This property is known as ductility.

The filaments of electric bulbs are made of fine wires of tungsten (Figure 7.2). Tungsten can be drawn into fine wires. Hence it is used to make the filament.

Platinum is the most ductile metal. You may have seen metals like copper, gold etc., being used as thin fine wires. This is due to their high ductility.

Hardness is yet another property of metals.

However, there are quite a few metals which are soft. Let's do an experiment. Take a small piece of sodium with a forceps and try to cut it with a blade. Are you able to cut sodium? Can you cut metals like copper, aluminium and iron like this? Just try. Gallium and cesium are also soft metals.

Lithium, sodium and potassium are soft metals. We can easily cut them with a knife.

Observe the newly formed surface of sodium when it is cut with a knife. What peculiarity do you observe? Don't you see something similar at the freshly cut surfaces of iron and copper as well?

The surface newly formed when metals are cut, has a shining appearance. This property is known as metallic lustre.

Is metallic lustre identical for all metals? Observe and find out.

- Metallic vessels are commonly used for cooking. Which metals are commonly used to make utensils?

- Which characteristics of metals are made use of in this case?

The ability to conduct heat is an important property of metals. This property is known as thermal conductivity.

Metals are thermal conductors.

Silver is the best thermal conductor among metals. Aluminium, copper etc., also possess comparatively high thermal conductivity.



Fig. 7.2



Fig. 7.3

All metals are conductors of electricity.



Fig. 7.4

The ability of a substance to let electricity pass through it is known as electrical conductivity. Silver is the best electrical conductor among metals. Copper and aluminium are also good conductors of electricity. Still, the electrical wires in our houses are made of copper. Similarly, the electric wires that we see on electric posts outside our houses are made of aluminium. What could be the reason?



Fig. 7.5

- -----
- -----
- -----

Tap gently with a spoon on a metallic vessel and an earthen pot.

- What difference do you find?

- Is it advisable to use plastic or wood to make instruments like cymbals and bells?

- What kind of materials are used to make them? What could be the reason for this?



Fig. 7.6

The ability of metals to produce sound when tapped with a hard material is known as sonority.

Metals generally melt at high temperatures and possess high density.

However, metals like gallium, cesium and mercury melt at low temperatures.

Metals like lithium, sodium and potassium are low density metals.

The table given below shows the melting point, boiling point and density of some metals. Analyse the table.



Metal	Melting point (°C)	Boiling point (°C)	Density (g cm ⁻³)
Iron	1538	2861	7.873
Silver	961	2162	10.500
Gold	1064	2836	19.281
Tungsten	3414	5555	19.254
Titanium	1670	3287	4.508
Copper	1084	2562	8.933
Chromium	1907	2671	7.194

Table 7.2

Based on the above discussions, we can now summarise the general physical properties of metals.

- High thermal conductivity
- High electrical conductivity
- Sonority
- High melting point
- High density
- Malleability
- Ductility



See the section 'Lohangal' in School Resources in IT@School Edubuntu

Given below are situations which make use of some physical properties of metals. Complete the table.

Use	Property
To make electric wires	
To make aluminium foils to wrap food materials	Can be beaten into thin sheets
To make utensils	
To make farming tools	
To make bells used in places of worship	

Table 7.3

Thus, metals have certain physical properties in common. Do they show similarity in their chemical properties as well?

You might have observed the following :

- Iron articles kept outside our houses get destroyed through rusting over a period of time.
- Gold, silver and platinum are usually used for making ornaments.
- Buttermilk is not stored in aluminium vessels.
- Verdigris (*clav*) is formed on copper vessels.

Have you ever thought of the reason behind this? Let us do some experiments.



Alloys

An alloy is a solid solution which is a homogeneous mixture of two or more metals. Compared to metals, alloys possess better strength and resistance to corrosion. More than 90 percent of metals are used in the form of their alloys. Alloys represent a large class of construction materials with superior properties. An alloy of gold and copper is used for making ornaments. The components of some alloys are given below.

Alloy	Components
Brass	Copper, Zinc
Bronze	Copper, Tin
Nichrome	Nickel, Chromium, Iron
Alnico	Iron, Aluminium, Nickel, Cobalt

Small amounts of non metals like carbon, silicon etc., are also added to certain alloys (eg. stainless steel).



See 'Lohangal nashikkunnathu Thadayan' in School Resources in IT@School Edubuntu

Reaction with air

Cut a small piece of sodium with a knife. Observe the metallic lustre at the newly formed surface. Keep it exposed to air for some time.

- What happened to the surface? What could be the reason?

- Take an aluminium wire and rub its surface with sand paper. Don't you see a bright metallic lustre? Within a few days, it gets tarnished. Why does it happen?

- Metals like copper, magnesium etc., also react similarly with atmospheric air.

When metals come into contact with atmosphere, they undergo chemical reaction with different components of air. As a result, the metal loses its lustre and gets tarnished.

Reaction of metals with water

Take two beakers and fill three-fourth of them with water. Put a small piece of sodium in the first beaker and a piece of copper in the second. Write down your observations.

- Which of these metals reacted with water?

- Which gas was formed during this reaction?

Under favourable conditions, certain metals react with water to form hydrogen gas.

Write down the chemical equation for the reaction between sodium and water.

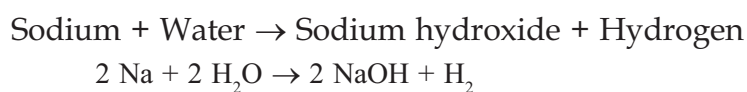

The metals potassium and calcium also react with cold water.

Reaction of metals with acids

You have already studied the reaction of zinc with dilute hydrochloric acid. Write down the products formed as a result of this reaction.

 Repeat the experiment by adding metals like zinc, aluminium, iron and magnesium in different test tubes containing dilute hydrochloric acid. What do you observe?

- Which of these metals reacted with the acid?

- Which of these metals reacted most vigorously?

- Is there any metal which did not react with the acid?

- Which gas is liberated during these reactions? How would you detect it? Try to find out.
- Is there any difference in the vigour of the reaction of the metals with the acid?

Let's write down the balanced chemical equation of some of these reactions.

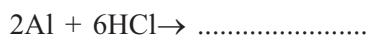
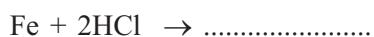
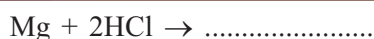
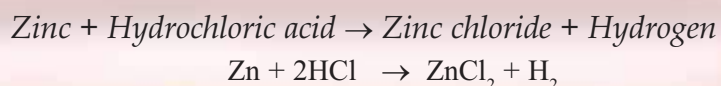

When metals like aluminium, zinc, magnesium and iron react with acids, hydrogen gas is formed along with the salt of the metal.

You have studied that acids are present in lemon and buttermilk. Now you can guess why a stainless steel knife is preferred to an iron knife to cut lemons and also why it is not wise to store buttermilk in aluminium vessels.



Where do metals come from?

Metals are isolated from naturally occurring materials containing metallic compounds. Such materials found in the earth's crust are known as minerals. Metals are separated from them by chemical processes. Gold is a metal which exists in free state. Aluminium is the most abundant metal on the earth's crust followed by iron and calcium.



Metals in human body too!

Though needed only in small quantities, the presence of certain metallic minerals is essential for the normal functioning of the human body and for health and nutrition. Haemoglobin, the compound which gives red color to blood, contains iron. Calcium is essential for the growth of teeth and bones. Salts of sodium and potassium are essential for the proper functioning of cells. Traces of metals like zinc, copper and selenium are essential for maintaining the health of a person.



See 'Acidum Lohangalum' in School Resources in IT@ School Edubuntu



Fig. 7.7

Corrosion of Metals

Iron is a metal used extensively in our daily life. Do the articles made of iron undergo any change over a period of time?

Is it only for the purpose of beautification, that we paint the iron bars of windows in our houses?

What would happen if we do not do so?

Do you know the factors which favour the rusting of iron?

Shall we do a project?

Materials Required

Clean and dry test tube	- 4 Nos.
Rust-free and clean iron nails	- 4 Nos.
Quick lime	- 10 g
Sodium chloride solution	- 25 mL
Dilute hydrochloric acid/Vinegar	- 25 mL
Cork	- 1 No.

Procedure

Put the iron nails, one each, in the four test tubes (Figure 7.8). Drop a small piece of moist cotton in the first test tube and keep it exposed to atmospheric air.

In the second test tube, put some quick lime and keep it closed (Quick lime can absorb moisture).

In the third test tube, pour some sodium chloride solution such that half of the nail stays immersed in it.

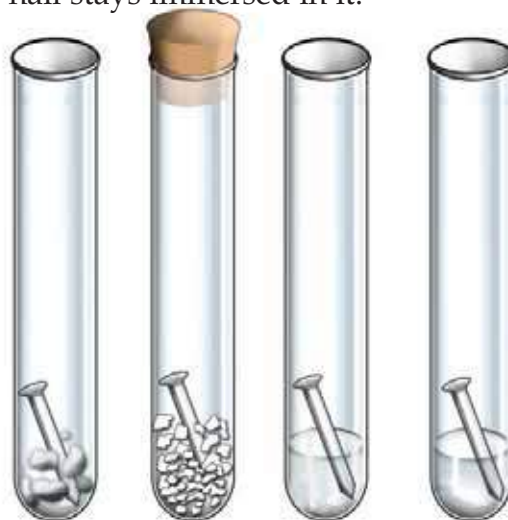

Fig. 7.8

In the fourth test tube, pour some dilute hydrochloric acid/vinegar to immerse half of the nail.

Observe the changes that occur to the iron nails after one week.

- Which test tubes had their nails rusted?
- Which test tubes had the maximum amount of rust in the iron nails kept in them?
- What are the factors which favour the corrosion of an iron article kept exposed to atmosphere?
- Which of the nails did not rust? What could be the reason?

Iron gets rusted when it enters into a chemical reaction with the oxygen and moisture present in the atmosphere.

- Why do you think the iron window bars in houses close to the sea shore corrode faster?
- Metals like sodium and potassium are stored in kerosene. Why?

Iron and a number of other metals react with different components of air and form new products. This process is known as **corrosion of metals**.

Are there metals which are resistant to corrosion? Which are they? What are their uses? Prepare a note on this.

What possible steps can be adopted to prevent the rusting of iron?



Significant learning outcomes

The learner can

- identify the physical properties of metals and use them in daily life.
- produce hydrogen gas by the reaction between metals and acids.
- explain why metals lose their shining appearance.
- suggest different methods to prevent the corrosion of iron.



Let us assess

- Some metals are listed below. Complete the table by identifying the different uses and the properties which are responsible for the same.

Metal	Use	Property
Gold	• •	
Copper	• •	
Aluminium	• •	
Zinc	• •	
Iron	• •	

- Iron is a metal which corrodes fast.
 - What are the factors that favour the corrosion of iron?
 - In coastal regions, copper nails are preferred to iron nails. What could be the reason?
 - Can you suggest some measures to prevent the corrosion of iron?
- Based on the physical properties of metals, indicate whether the following statements are true or false

1	Aluminium is a conductor of electricity	✓
2	The metal cesium melts at high temperatures	
3	Platinum is a metal with poor malleability	
4	Potassium is a hard metal	
5	Copper metal is sonorous	
6	The density of gold is very low	
7	Copper is a good conductor of heat	
8	Sodium is a hard metal	

9	One of the reasons for the use of gold in making ornaments is its metallic lustre	
10	The ductility of tungsten is high	

4. Which among the following metals is stored in kerosene?
(a) Sodium (b) Iron (c) Tungsten (d) Chromium
Why is it stored in kerosene?
5. The names of some metals are given below.
Tungsten, Gold, Sodium, Copper, Iron, Magnesium
Answer the following questions by selecting the appropriate ones from the list.
- Which metal with high malleability is used for making ornaments?
 - Which of these metals reacts with cold water?
 - Which of these is a hard metal but corrodes easily?
6. Give reasons for the following statements.
- Tamarind is not stored in aluminium vessels.
 - It is a common practice to apply oil on iron articles and tools.
 - Stainless steel knives, instead of iron knives, are preferred for cutting citrous fruits.



Extended activities

1. Comparison of conductivity

Materials required

Identically sized wires of copper, iron, aluminium and nichrome, torch bulb, 3 volt battery, switch

Procedure

Connect a torch bulb to the battery with the different metal wires. Find out which wire gives the highest brightness to the bulb? Arrange the wires in the decreasing order of their electrical conductivity.

2. Collect the following materials: an iron nail, an aluminium wire, a pencil lead, a copper wire, and the carbon rod of a dry cell. Beat them hard using a hammer. Which of them

can be flattened? What is your conclusion from this experiment?

3. You have understood the properties of metals. Find out the metals mentioned in the following cases.
 - Which metal is used in the storage batteries of vehicles?
 - Most of the metals are solids. Which metal exists as a liquid even at low temperatures?
 - Iron articles are coated with other metals to protect them from corrosion. Which are the two metals usually used for this purpose?
 - Metals have high density. Which is the densest metal?



Unit
8

Measurements and Units

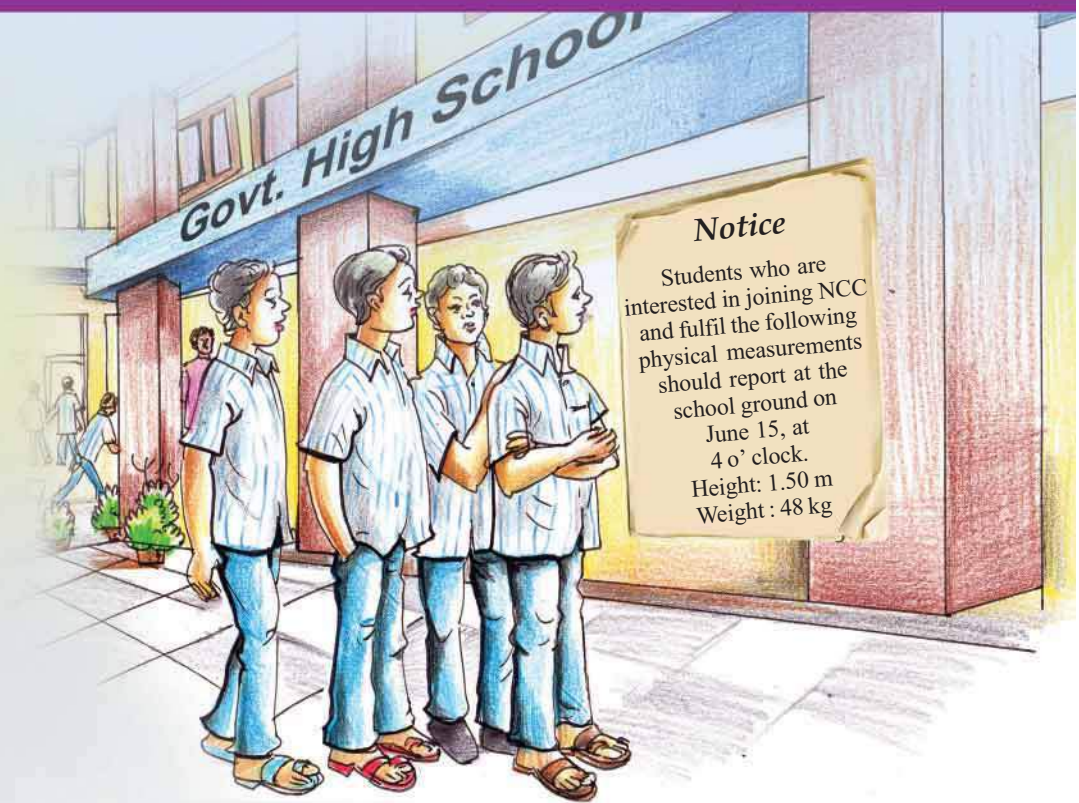

The students who read this notice decided to check their height and weight. Can you help them?

Length

Measure the length of the table in your classroom using the pencil in each student's hand and write it down in the table given below.

Sl. No.	Name of student	Length of the table (in pencil measure)



Fig 8.1

Table 8.1

- Compare your measurements with those of others.
- Are all measurements the same?
- Why are the measurements not equal?
- Don't you feel that all should have got the same measurement? What can we do about it?

Try to measure the length of the same table using the ribs of a coconut tree leaf, of the same length.

Now, isn't the measurement that everyone got the same? Didn't you understand that while measuring the length of an object, the results of all will be the same only if all use objects of same length or same scale to measure?

In olden days different scales were used for measuring length. Write down the scales familiar to you.

- *vaara*
- one forearm (*muzham*)
-

Now, try to write down the difficulties that arise due to the use of different scales in different parts of the world.

- Accuracy cannot be ensured.
-

Let's see how this problem has been solved.

A standard scale of a definite length has been recognised world wide for measuring length. This standard scale is the unit of length.

The basic unit of length is metre. Its symbol is m.

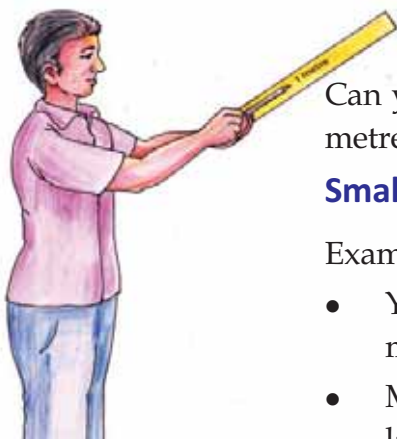

Fig 8.2

Can you measure the length of a pencil accurately using a one metre long rod?

Smaller units of length

Examine a metre scale.

- You might have observed long lines as well as numbers marked along its sides.
- Markings on the scale start from one. Which marking falls last on the scale?

A metre scale is divided into 100 equal parts. The length of each part is one centimetre (cm). This is useful in measuring a length which is less than one metre.



Fig 8.3

Observe the figure showing a part of a scale.

Now you know that the length between two successive long lines is 1 cm.

Observe the short lines in between two successive long lines.

- Into how many equal parts is 1 cm divided?
- What is the use of such a division?

1 cm is divided into ten equal parts. The length of each part is one millimetre. This becomes useful to measure a length which is less than one centimetre.

$$1 \text{ m} = 100 \text{ cm}$$

$$1 \text{ cm} = 10 \text{ mm}$$

If so, find out how many mm is 1m.

Draw a line segment of length 8 cm in your science diary and mark the following.

$$PQ = 6 \text{ mm}$$

$$PR = 16 \text{ mm}$$

$$PS = 5 \text{ cm}$$



Fig 8.4

The smallest length that can be accurately measured using a metre scale is its least count. Find it out and record it in your science diary.

Thickness of a paper

Can you measure a length less than a millimetre using a metre scale? For example, let's see how we can measure the thickness of a sheet of paper.

Take 100 sheets of paper and pile it up to make a bundle. Measure the height of this bundle using a scale. If it falls in between two markings, make suitable changes in the number of sheets. Then measure its height.



Metre

One metre is the length between two markings in the sample rod made by adding 10% iridium in platinum and preserved at 0°C at the International Bureau of Weights and Measures in Paris.

The length of the scale made by comparing its length with this sample rod is considered to be one metre.

According to the modern definition one metre is the distance travelled by light in vacuum in $1/299792458$ second. This new definition has been accepted for getting better accuracy.

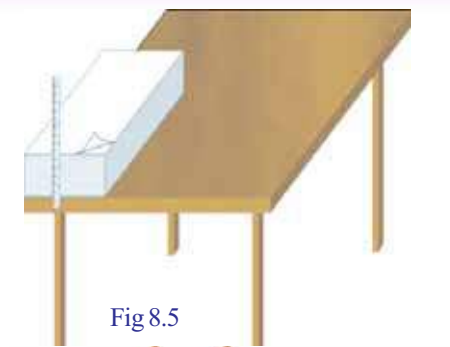

Fig 8.5

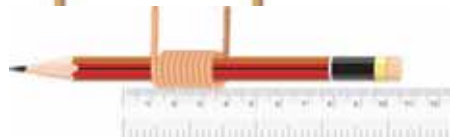

Fig 8.6



Fig 8.7

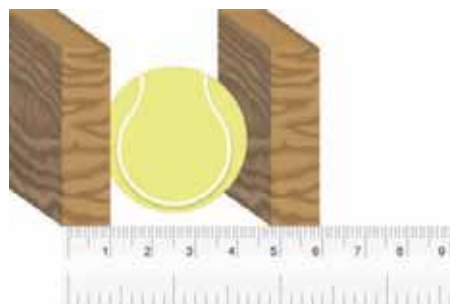

Fig 8.8

By dividing this height by the number of sheets, won't we get the thickness of a sheet of paper?

Observe Fig.8.6 and find out how the thickness of a thin metal wire can be found. Now try to measure the thickness of similar objects.

Length of a curved line

Discuss how you can measure the length of the curved line shown in Fig.8.7 using a thread and a metre scale. Do you think you will be able to measure it by placing the thread over the curved line? Try it. Note down the length in the science diary.

Length of the curved line AB = cm

Let's measure the diameter of a sphere

Have you ever thought of measuring the diameter of a sphere?

Observe Figure 8.8 showing an object (for example a ball) kept in between two wooden blocks, whose diameter is to be measured. Measure the diameter of the ball and write it down in the science diary.

Diameter of the ball = cm

The basic unit of length is metre. Smaller units like centimetre (cm), millimetre (mm), micrometre (micron - μm) nanometre (nm) are also used in certain situations for convenience. We use a bigger unit like kilometre (km) to measure the distance between two places. Units like astronomical unit (AU), light year (ly), paralytic second known as parsec (pc) etc., are used for measuring distance to planets or stars. One astronomical unit is the average distance from the earth to the sun. This distance is approximately 15 crore kilometre. One light year is the distance travelled by light in one year. In vacuum, light travels 3 lakh kilometre in one second. Parsec is 3.26 light year.

Measurement	Value in metre		
1 km	1000 m	=	10^3 m
1 cm	1/100 m	=	$\frac{1}{10^2}$ m = m
1 mm	1/1000 m	=	= m
1 μm	1/1000000 m	=	= m
1 nm	1/1000000000 m	=	= m

On the basis of the given information, answer the following questions:

- The use of plastic carry bags having thickness below the stipulated level has been prohibited. In which unit is the thickness of such bags expressed?
- The distance from the earth to a planet in the solar system is 4 AU. What do you mean by this?
- Find out how many kilometre is one light year and write it down in your science diary.
- Which is the convenient unit to express the distance from the earth to the star *thiruvathira*?

In order to measure the length of an object accurately, we should be careful about certain points. Try to understand these points analysing Fig 8.9 (a) (b) (c).

What will you do if the edges of a scale are broken or if the markings are not clear? Note it down in your science diary.

- Instead of measuring from the first marking on the scale start from another whole number.
-

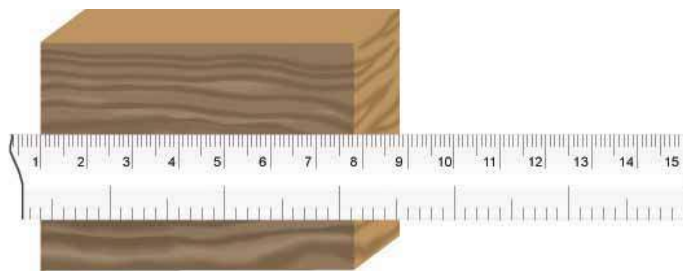

Fig 8.10

- What is the length of the pencil shown in Fig 8.9 (c)? Note it down.

Now you might have understood the basic unit for measuring length and its smaller as well as bigger units. You might have also observed the situations in which length is to be measured. Have you ever bought sugar from a shop? In which unit do you get it? What does this measurement indicate?



Fig 8.11

Precautions to be taken while measuring length

While measuring the length of an object, keep the scale close to the object without any inclination, as shown in Figure 8.9(b)

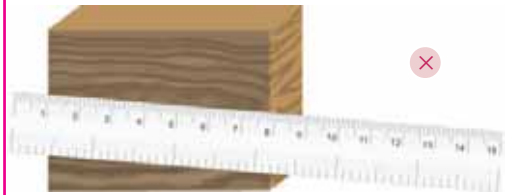

Fig 8.9(a)

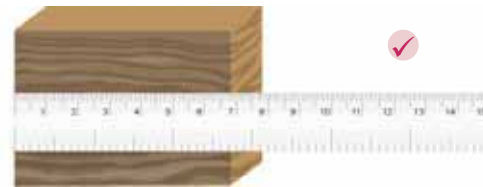

Fig 8.9(b)

The position of the eye is very important while taking the measurement. Observe the figure 8.9(c) and understand where the position of the eye should be.

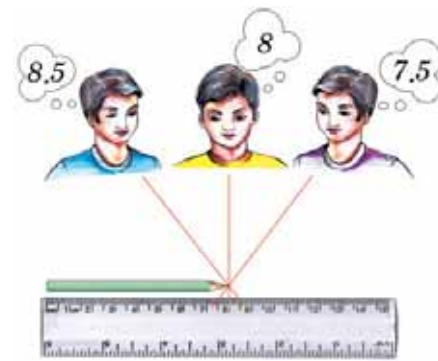

Fig 8.9(c)



Fig 8.12(a)



Fig 8.12(b)

Mass

Observe the picture showing how sugar is weighed in a shop.

- It is done after placing a weight block in one pan. What is the purpose of placing the weight?
- How are the measurements in both the pans in the second picture? This is done to get the same amount of sugar as that of the matter in the weighing block.

Mass of a substance is the measure of the quantity of matter contained in it.



Fig 8.13

Observe the weight block shown in Fig.8.13

What is the marking on it? On each weight block its mass will be marked. The mass of the weight block shown in the figure is 2 kilogram. The basic unit of mass is kilogram.

The basic unit of mass is kilogram. Its symbol is kg.



One kilogram mass

We consider one kilogram as the mass of a cylinder made of an alloy of 90% platinum and 10% Iridium kept at the International Bureau of Weights and Measures in Paris.

A similar one is kept at the National Physical Laboratory in New Delhi.



In addition to the basic unit kilogram, we use other smaller as well as bigger units to suit our convenience for measuring mass. milligram (mg), gram (g), quintal, tonne etc., are some among them. From the table given below find out their relationship with kilogram.

Measurements	Value in kilogram(kg)
1 mg	$1/1000000 \text{ kg} = \frac{1}{10^6} \text{ kg} = 10^{-6} \text{ kg}$
1 g	$1/1000 \text{ kg} = \frac{1}{10^3} \text{ kg} = 10^{-3} \text{ kg}$
1 quintal	$100 \text{ kg} = 10^2 \text{ kg}$
1 tonne	$1000 \text{ kg} = 10^3 \text{ kg}$

Table 8.2

Now, let's see how time, another quantity is measured.

Time

The given picture shows the shadow cast by the flag pole of your school in the morning, at noon and in the evening.



Fig 8.14(a)
Morning



Fig 8.14(b)
Noon



Fig 8.14(c)
Evening

- Of these, at what time is the shadow of the least length cast?
- What may be the reason?
- Have you ever tried to ascertain the time by observing the difference in the length of shadows?

Our ancestors used to determine approximate time by observing the shadow of objects. They used the sundial as well. Suggest a method to make a sundial.

- Is the sundial you have made, suitable for use at night?
- What might have been the measures taken by our ancestors to ascertain time at night? Discuss.
- By what name is the time from one noon to the next noon referred?
- For measuring time intervals less than a day, a day is divided into twenty four equal parts. What is each of this duration of time referred as?

Aren't you aware that the time obtained by dividing this part into 60 equal parts is a minute?

- The time interval obtained by dividing a minute into 60 equal parts is the basic unit of time. What is it known as?
- How many seconds make a day (one solar day)?



sundial
Fig 8.15

Solar day

A day or a solar day is the time period from one noon to the next noon.

The basic unit of time is second. Its symbol is s.

One second is $1/86400$ part of an average solar day.

Fundamental units

You are now familiar with the units of length, mass and time. There are some quantities which are not related to one another and cannot be expressed using other quantities. Such quantities are fundamental quantities. The units of the fundamental quantities are the Fundamental Units. The system based on these fundamental units is the International System of Units. Its short form is SI Units.

In addition to length, mass and time, which are the other fundamental units as per SI system? Find them out by examining Table 8.3



Fundamental Quantities and their SI units

Sl. No.	Fundamental quantities	Basic SI Units	
		Name	Symbol
1	Length	metre	m
2	Mass	kilogram	kg
3	Time	second	s
4	Electric Current	ampere	A
5	Temperature	kelvin	K
6	Amount of Substance	mole	mol
7	Luminous Intensity	candela	cd

Table 8.3

There are some other quantities you should be familiar with, that are not included among fundamental units. Write them down.

- Area
- Volume
-

Derived Units

Let's try to find the area of a classroom of length 5 m and breadth 4 m

$$\text{Area} = \text{length} \times \text{breadth} = 5 \text{ m} \times 4 \text{ m} = 20 \text{ m}^2$$

From the answer obtained, can you find out the unit of area? Is the unit of area included in the table of fundamental units?

How did you calculate the unit of area?

$$\begin{aligned} \text{Unit of area} &= \text{unit of length} \times \text{unit of breadth} \\ &= \text{m} \times \text{m} = \text{m}^2 \end{aligned}$$

You might have understood that the unit of area is stated using the fundamental unit of length. Such units expressed using fundamental units are derived units.

Units which are expressed in terms of fundamental units or those units which are dependent on fundamental units are derived units.

On the basis of the above information, let's take a look at the salient features of SI units.

- Unified units
- Internationally accepted
- Adequate to express all physical quantities.

Can you find the area of a surface having irregular edges using the method adopted to find the area of your class room? Let's look at the example of finding the area of a leaf.

Area of a leaf

Let's find out the area of a leaf. Take the leaf and place it on a graph paper and trace the outer edges using a pencil.



Fig8.16

After removing the leaf, examine the graph paper and complete the table given below.

(a) Number of complete squares	
(b) Number of squares having half or more	
(c) Total number of squares (a+b)	

Table 8.4

The total number of squares will be the approximate area of the leaf.

Approximate area of the leaf = cm².

Volume and Density

Take a rectangular wooden block and a rectangular thermocol block which are of the same size. How much space do they occupy? The space occupied by a body is referred to as its volume. Let's see how we can find this.

Measure the length, breadth and height of these blocks. Their product is the volume.

Volume = length × breadth × height

What is the volume of a block of length 0.2 m, breadth 0.01 m and height 0.05 m?

We can find out the unit of volume using the equation given above. The unit of volume is cubic metre (m³). Is it a derived unit? Specify the reason.

Find out the mass of these blocks using a common balance and complete the table.

Sl. No.	Object	Volume (m ³)	Mass (kg)	Mass/volume (kg/m ³)
1	Thermocol block			
2	Wooden block			

Table 8.5

Let's examine how the mass of a thermocol block and a wooden block are different, though they have the same volume.

$\frac{\text{mass}}{\text{volume}}$ or mass per unit volume of a substance is referred to as

its density. Though having the same volume, the density of wood is greater than that of thermocol. This means that the quantity of matter contained in the wooden block is greater. This is the reason behind the difference in their masses.

$$\text{Density} = \frac{\text{mass}}{\text{volume}}$$

$$\text{Unit of density} = \frac{\text{unit of mass}}{\text{unit of volume}} = \text{kg} / \text{m}^3$$

Is the density of all substances the same?

Do the experiment given below and note down your inference in the science diary.

Take equal volumes of water and saturated solution of sodium chloride (brine) in two jars. Fill it slightly less than half of their volumes. Put an egg first in water and then in the brine solution. What do you observe? In which jar does the egg float? Even though water and brine solution have the same volume, the mass of brine solution is greater than that of water. This means that compared to water, brine solution has a greater density.

Add artificial yellow and red food colour to the brine solution and water respectively. Stir them well. Slowly pour the red coloured water into the brine solution. Write down the observations in your science diary.

- Which coloured solution is seen above?
- Which solution has the higher density – yellow brine solution or red coloured water? Discuss the reason.

You might have observed that the brine solution has a greater mass. It is due to the difference in the mass of substance having the same volume or density that water floats above the brine solution.

Take kerosene in one jar instead of salt solution and pour water into it. What do you observe? Based on



Fig 8.17



This is the figure showing a person reading newspaper while floating on the Dead sea situated between Jordan and Palestine. Why is it that no one sinks in the Dead sea? This is the place where the density of salt solution is the highest. Here, one litre water contains about 340 g of salt. The density of normal sea water is only 35 g/L

the above observation, answer the following questions and write it down in your science diary.

- If petrol, diesel etc., catches fire one should never try to extinguish it using water. Why?

The rules to be followed while writing units

Haven't you understood fundamental measurements and their units? We have to observe certain rules according to international standards while using these units and their symbols. They are given below:

- (1) The symbols of units are normally written using small letters in the English alphabet. eg. m (metre), s (second), kg (kilogram)
- (2) But there are certain occasions on which capital letters of the English alphabet are used as symbols. The units named after persons are written like this.

Name of person	Physical quantity	unit	symbol
Alessandro Volta	Potential difference	volt	V
Blaise Pascal	Pressure	pascal	Pa
Sir Isaac Newton	Force	newton	N

Table 8.6

- (3) While writing the names of units never use capital letters.
eg. kelvin (*correct*) Kelvin (*wrong*)
 newton (*correct*) Newton (*wrong*)
- (4) Never use the plural form for symbols.
eg. 10 kg (*correct*) 10 kgs (*wrong*)
 75 cm (*correct*) 75 cms (*wrong*)
- (5) Never use full stop or comma after a symbol except at the end of a sentence.
eg. 75 cm is the length of a table. (*correct*)
 75 cm. is the length of a table. (*wrong*)

- (6) While writing derived units a slash (/) is used to denote division. But never use more than one slash in one derived unit.
eg. m/s^2 (*correct*) m/s/s (*wrong*)
- (7) When a derived unit is expressed as the product of other units use a dot or a space between them.
eg. N.m or N m
- (8) Do not mix the name of a unit with the symbol
eg. kg/m^3 (*correct*)
kilogram per cubic metre (*correct*)
kg/cubic metre (*wrong*)
kilogram per m^3 (*wrong*)
kg per m^3 (*wrong*)
kilogram/ m^3 (*wrong*)
kilogram/cubic metre (*wrong*)
- (9) While writing units along with a value, there must be single space between them.
eg. 273 K (*correct*) 273K (*wrong*)
100 m (*correct*) 100m (*wrong*)
- (10) Never use more than one unit to express a physical quantity.
eg. 10.25 m (*correct*) 10 m 25 cm (*wrong*)



Significant learning outcomes

The learner can

- explain the necessity of measurements of physical quantities and their units.
- describe the necessity of unified units.
- recognise derived units based on SI units and use them appropriately in different situations.
- recognise the features of SI units and use them appropriately in different situations.
- explain the concept of mass, volume and find the density of substances.
- record units and their symbols properly in different situations.



Let us assess

- Write down the following units in the ascending order of their values
 - mm nm cm μm
 - 1 m 1 cm 1 km 1 mm
- Which of the following units does not belong to the group?
 - kg mg g mm
 - μm mm km mg
- Imagine that the distance from school to your friend's house is 2250 m. State this in kilometres.
- Convert the following units into SI units without changing their values.
 - 3500 g b) 2.5 km c) 2 h



Extended activities

- Find out the units used in earlier days to measure length and compare them with metre.
- Enquire and collect details about former systems of units like CGS, MKS, FPS and find out their relationships with the fundamental SI units.
- Collect pictures of the instruments used by our ancestors to determine time like sundial. Prepare their charts and exhibit them in class.



Unit
9
Motion



Sir, how fast does the soaring plane fly out of sight!

There is nothing so surprising about it. Aren't we too moving at great speed?



"How is that possible sir? Aren't we still now?"

"Not at all. Now we are moving."

How do we know whether a body is in a state of motion or at rest?

Let's see.

Analyse Table 9.1 and complete it suitably.

Situation		State of motion	State of rest
A passenger in a moving bus	with respect to the bus		✓
	with respect to the road		
A crow sitting on a cow grazing in a field	with respect to the cow		
	with respect to the ground		
A child standing in a field.	with respect to the ground		
	with respect to the sun		
A book on a rotating table			✓
		✓	

Table 9.1

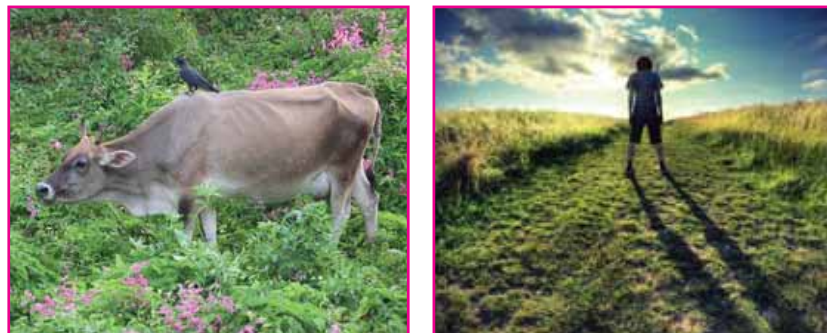

Fig. 9.1

From the analysis of the table, didn't you understand that we can state whether an object is in a state of rest or motion only with reference to another object? The object which is taken as reference is the reference body.

Reference body is the object with respect to which the state of rest or motion of an object is described.

If the position of an object changes with respect to the reference body then the body is said to be in motion. If the position does not change, the body is said to be at rest.

A body in motion undergoes a change of position. How can we determine this?

Distance and Displacement

The path through which a person travelled to his office and returned home are depicted in Fig.9.2. He took the road near the hospital to go to the office.

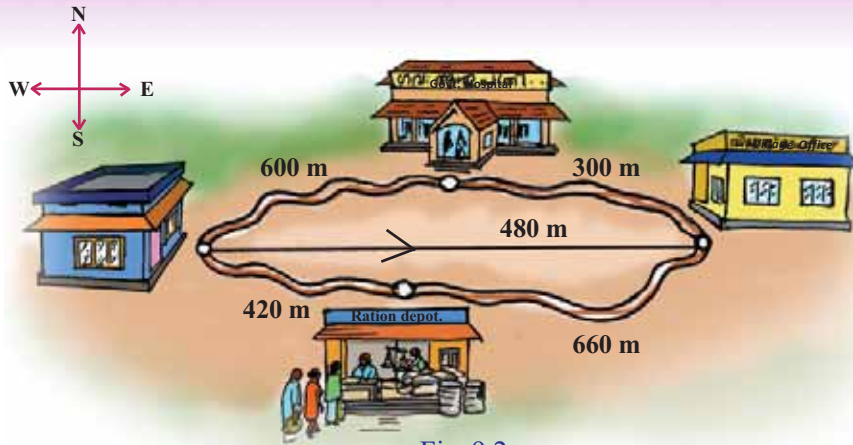

Fig. 9.2

But he came back through the road along the ration depot. Let's analyse the distance he travelled. The length of the road taken for travelling is the distance.

Distance is the length of the path travelled.

- What is the distance travelled by him to reach the office? And to reach home?.
- Are the distances travelled in both the situations equal?
- Find the straight line distance from his home to his office and write it down.
- Will he reach the office if he travels 480 m towards north?
- In which direction should he travel 480 m to reach the office?

This 480 m straight line distance from home to office eastwards is his **displacement**.

What is the total distance covered by him if he travelled from home to office and back home?

What is his displacement?

Displacement is the straight line distance from the initial position to the final position. It has both magnitude and direction. Its unit is metre (m).

A stone thrown vertically upwards travels to a height 6 m and falls back to the hand. On the basis of the above statement complete the table.

Situation	Distance travelled by the stone	Displacement of the stone
When the stone reaches the topmost position		
When the stone falls back in the hand		

Table 9.2

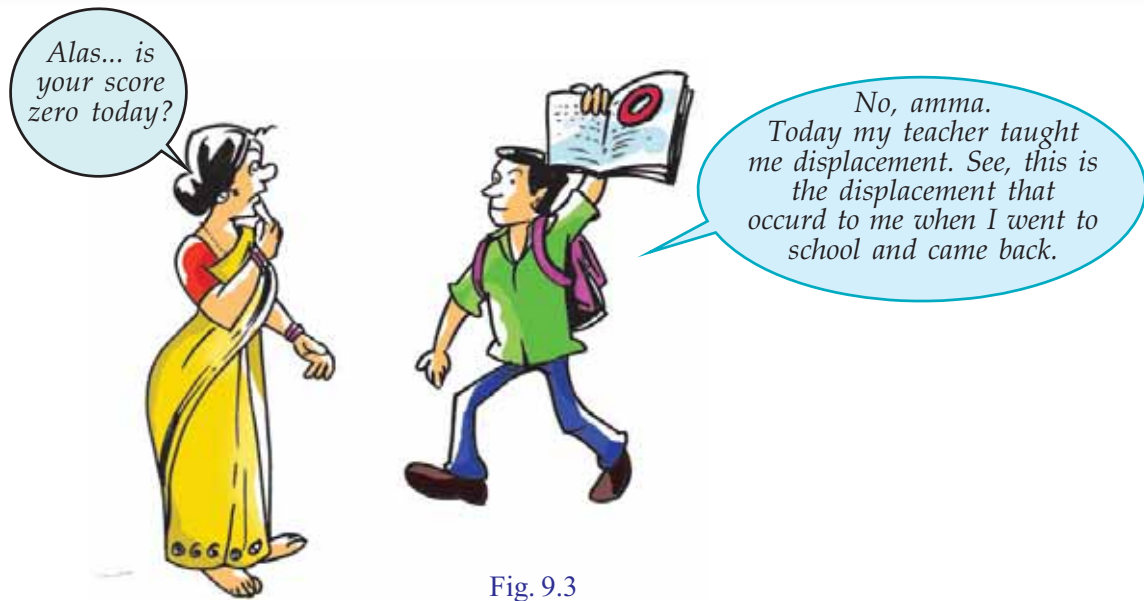
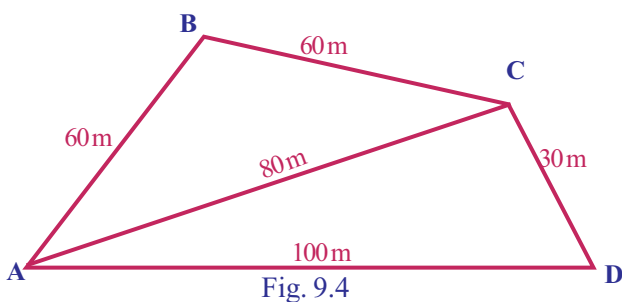

Fig. 9.3

While stating the displacement, it is necessary to indicate the direction along with the magnitude of the distance travelled. Such physical quantities having both magnitude and direction are referred to as vector quantities. Physical quantities of which the direction is not to be indicated, are scalar quantities.

- Displacement is a vector quantity. Is distance then a vector or a scalar quantity?



On the basis of the information you have gathered, observe Figure 9.4 and complete Table 9.3. A person starts his journey from A and goes to D through B and C and comes back to A.

Change of position of the traveller	While reaching B	While reaching C	While reaching D	While returning to A
Distance				
Displacement				

Table 9.3

Let's observe the two figures showing the journey of a person from A to C through B

While reaching C from A through B

- What is the total distance travelled according to Fig.9.5 (a)? What is the displacement?
- What is the total distance travelled according to Fig.9.5 (b)? What is the displacement?

Analyse the two answers obtained and find the situation in which the magnitude of distance and displacement becomes equal and write it down in the science diary.

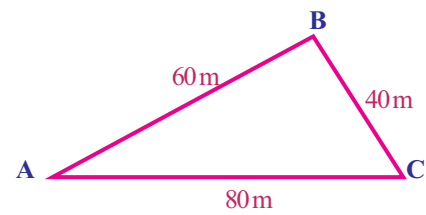

Fig. 9.5 (a)



Fig. 9.5 (b)

When a body travels along a straight line in the same direction, the magnitude of its distance and displacement will be equal.

On the basis of your findings, write down the differences between distance and displacement and complete Table 9.4

Sl No.	Distance	Displacement
1	scalar	vector
2		

Table 9.4



See 'dooravum staanaanharavum' in School Resources in IT@ School Edubuntu.



Speed and Velocity

Did you read the notice put up in the city? Hope you know that excess speed and careless driving are the two major reasons for accidents.

Do you know what excess speed is?

Let's use the measurements of Fig.9.2 and do another activity. The time taken to travel to the office and back home was 600 s each. Based on these measurements, try to complete table 9.5.



Stages of journey	Total distance travelled in metre (m)	Displacement in metre (m)	Time taken for the journey in second (s)	Distance travelled per second (in unit time)	Displacement per second (in unit time)
On reaching the office					
On reaching back home.					

Table 9.5

Displacement is the straight line distance from the initial position to the final position, irrespective of the path taken. While calculating velocity this straight line distance itself is the displacement, even if it is not the actual path taken. But the time taken to cover the actual distance should be used for the calculation.

*Speed is the distance travelled in unit time.
Velocity is the displacement in unit time.*

- Write down the equation for velocity, if speed = distance/time.
- Is the velocity and speed equal, while travelling from home to office?
- In which unit is speed expressed? What about velocity?
- What is the speed with which the person travelled?
- What is his velocity as he reaches home?
- Velocity is a vector quantity. What do you think speed is?

Observe the depiction of the path taken by an object as it moves from A to C through B (Fig.9.6).

Calculate the speed and velocity of the object.

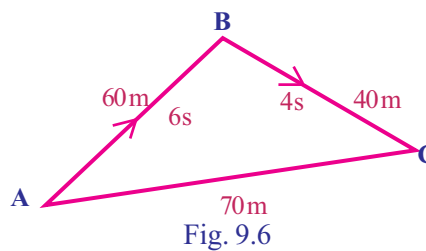

Nautical mile

Nautical mile is the unit for measuring the distance in the field of aviation and sea transportation. One nautical mile is 1.852 km. The unit for measuring the speed of aeroplanes and ships is knot. One knot is the speed taken to travel one nautical mile in one hour.

Find out the situation in which the magnitude of speed and velocity become equal and write it down .

Tabulate the differences between speed and velocity.

Sl. No.	Speed	Velocity
1	Scalar quantity	Vector quantity
2		

Table 9.6

Uniform speed and Non uniform speed

Observe the figure showing the distances travelled by a car during different time intervals.



Fig. 9.7

Analyse Fig. 9.7 and complete Table 9.7

Distance travelled		Time	Speed
A → B	20 m	2 s	10 m/s
B → C			
C → D			
D → E			
E → F			



See 'vegam' in School Resources in IT@ School Edubuntu

Table 9.7

Do you think that the distance travelled by the car in equal intervals is the same? If so, isn't the car in uniform motion? In such situations, we say that the car has uniform speed. Observe Fig.9.8. The distance travelled by a car and the time taken for it is recorded.

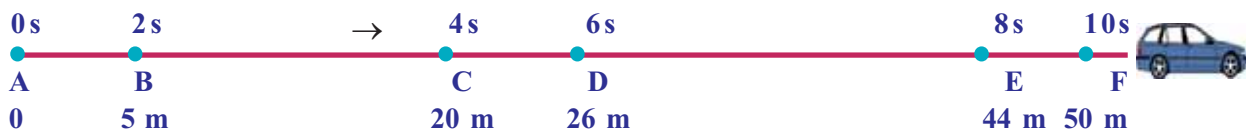

Fig. 9.8

Analyse the figure and complete Table 9.8

Distance travelled		Time	Speed
A → B	5 m	2 s	2.5 m/s
B → C	15 m	2 s	7.5 m/s
C → D			
D → E			
E → F			

Table 9.8

Isn't the distance travelled by the car in equal intervals of time different here? If so, is the motion and speed of the car uniform or non uniform?

If a body in motion covers equal distances in equal intervals of time, the body is said to have uniform speed. If it covers unequal distances in equal intervals of time, the body is said to have non uniform speed.



Speedometer

Fig. 9.9



See 'veganirnayam' in School Resources in IT@ School Edubuntu

A child watching the speedometer of a vehicle realised that the meter was displaying different speeds at different times. How can the speed of vehicles be determined in such situations? Average speed alone can be calculated.

Let's calculate the average speed of the car using the data from Fig 9.8

Total distance travelled by the car from A to F = 50 m

Total time taken for travelling this distance = 10 s

$$\text{Average speed} = \frac{\text{Total distance travelled}}{\text{Time taken to travel the distance}}$$

$$= \frac{50 \text{ m}}{10 \text{ s}} = 5 \text{ m/s}$$

You are now familiar with uniform and non uniform speed. Now let's see what uniform and non uniform velocities are.

Uniform velocity and Non uniform velocity

The details of the journey of three cars are given below.

Car A travelled 500 m along a straight line.

The car covered equal distances in equal intervals of time.

Car B travelled 500 m along a straight line.

The distance covered by the car is unequal in equal intervals of time.

Car C travelled 500 m along a circular path.

The car covered equal distances in equal intervals of time.

Analyse these and write down answers to the following questions.

- Is the velocity of Car A the same in each second? Why?
- Is the velocity of Car B the same in each second? Why?

If the direction of motion changes, the velocity also changes.

- Is the velocity of Car C the same in each second? Why?

A body has uniform velocity if it covers equal displacements in the same direction in equal intervals of time.

If either speed or direction changes, the velocity is non uniform.

Complete Table 9.9 based on the above information.

	Uniform velocity	Non uniform velocity	Reason
Car A	✓		Neither the magnitude nor the direction changes.
Car B			
Car C			Magnitude of velocity does not change. Direction changes.

Table 9.9

You might have learned to distinguish between uniform velocity and non uniform velocity. Now find out examples for bodies travelling in uniform as well as non uniform velocity and write them down.

Uniform velocity

- when light travels through vacuum
-

Non uniform velocity

- a train starting and moving out of the station
-



Fig. 9.10

Acceleration

Imagine that you are sitting inside a car. The velocity of the car keeps on changing when it starts and moves forward along a straight line path. How does the driver manage this? Observe the Fig. 9.10 showing the use of a device used for bringing about change in velocity, namely the accelerator.

Details of the journey of a car in a straight line are given as a line diagram in Fig 9.11. Analyse the information and complete Table 9.10.



Fig. 9.11

Velocity at A is the initial velocity when we consider the journey from A to B. The velocity at B is the final velocity. While considering B to C, velocity at B is the initial velocity and that at C is the final velocity. This is the same in the case of other stages as well.

Distance travelled by the car	Initial velocity u	Final velocity v	Change in velocity v - u	Time taken for the change in velocity (t)	Rate of change in velocity or acceleration a = change in velocity / time $a = \frac{v-u}{t}$
A → B	0	5 m/s	5 m/s	5 s	$= \frac{5 \text{ m/s}}{5 \text{ s}} = 1 \text{ m/s}^2$
B → C					
C → D					
D → E					
E → F					

Table 9.10

Initial velocity and Final velocity

The initial velocity of a body is zero whenever the body starts from rest or is subjected for a free fall. The final velocity is zero when a body comes to rest. When a body is thrown up, the final velocity will be zero when it reaches the topmost position.

Haven't you found out the rate of change in the velocity of the car in each second? This is the acceleration of the car.

Acceleration is the rate of change in velocity.

$$\text{Acceleration} = \frac{\text{change in velocity}}{\text{time}}$$

$$a = \frac{v-u}{t}$$

Acceleration is a vector quantity.

Notice some situations in which acceleration occurs.

- the motion of a coconut falling from a coconut tree.
- a moving ball coming to rest.
- the motion of a ball rolling down a hill.

Write down more instances like this.

- A food packet dropped from a helicopter reaches the ground in 5 s. If the velocity with which it hits the ground is 50 m/s, what is the acceleration?

The acceleration produced in an object falling down freely due to the gravitational force of the earth is the acceleration at the place.

This is the acceleration due to gravity. It is represented by the letter g .

Retardation

- Examine Table 9.10 and find out whether the velocity of the car increases or decreases when it moves from D to E.

What is the rate of change of velocity?

- Does the velocity increase or decrease when the car moves from E to F?

What is the rate of change of velocity?

Didn't you observe that the acceleration is negative here? This kind of acceleration is known as retardation or negative acceleration. Its unit is also m/s^2 .

Find out whether the acceleration is positive or negative in the given situations.

- a ball rolling on a level ground.
- a train starting from the station.
- the motion of a stone thrown up-when it goes up and comes down.

Aren't you now familiar with the concepts of speed and acceleration? The speed of vehicles increases when there is acceleration. Excessive speed of vehicles may result in accidents.

We can minimise deaths due to accidents to a great extent if we obey traffic rules and signals put up on the side of the roads. Observe the sign boards given below.



Are the deaths caused by accidents the result of negligence and excess speed of vehicles alone? Don't you think that the carelessness of pedestrians is also one of the reasons? What precautions should pedestrians take? Write them down.



See how brisk I am

My name is Cheetah. I can run at a great speed. Do you know what my speed is? 25 m/s to 30 m/s. My speed changes from 0 to 20 m/s in 2 second. See how good my acceleration is!



- walk along the footpath only
- walk only along the right side of the road
- cross roads only at the zebra crossing.
- while walking along the road late in the evening or night avoid wearing black or dark coloured clothes.

-

What are the reasons for accidents on the road? Prepare an enquiry note.

Observe the table showing the maximum speed limit for different vehicles on roads of Kerala.



Permitted speed on roads of Kerala						
Vehicle	Maximum speed in km/h					
	In the premises of educational institutions	by-roads	In Municipal Corporations/Cities	National Highways	State High ways	Four lined roads
Motor car	30	45	50	85	80	90
Motor cycle	30	45	50	60	50	70
Autorickshaw	30	35	30	50	50	50
Bus	30	40	40	65	65	70

Table 9.11

GO (P) No.20/2014/Tran dated 28.02.2014

Organise a seminar on 'Road Safety' under the auspices of the School PTA. The topics for presentation can be excess speed of vehicles, carelessness of drivers, ignorance of pedestrians of road safety and the use of alcohol and drugs on the road.



Significant learning outcomes

The learner can

- distinguish between state of rest and state of motion with reference to the reference body.
- differentiate between distance and displacement and describe the situation in which their measures are equal.
- recognise that physical quantities having direction along with magnitude are vector quantities and others are scalar quantities and give examples for the same.
- distinguish speed from velocity and describe both.
- describe and find out examples for uniform speed, non-uniform speed, uniform velocity, non-uniform velocity, acceleration and retardation and solve mathematical problems based on them.
- explain the measures to be taken for road safety and engage in activities related to them.



Let us assess

1. Which of the following does not belong to the group?
(velocity, acceleration, speed, displacement)
2. The statement of a child is as follows: "My displacement is zero though I ran 250 m". What is meant by this?
3. All objects having uniform speed need not have uniform velocity. Describe with the help of examples.
4. Bus A covered 75 m in 5 s. Bus B covered 169 m in 13 s
 - a. Which bus covered a greater distance?
 - b. Which bus has a higher speed?
5. What is the acceleration of a car which started from rest and acquired a velocity of 40 m/s in 8 s?
6. A car covered the first 400 m distance with a speed of 8 m/s, the next 1200 m with a speed 12 m/s and the last 360 m with a speed of 12 m/s. Calculate the average speed of the car.
7. Does a body have acceleration in the following situations? Why?

- a body travelling along a straight line with uniform velocity.
 - a body travelling along a straight line with non-uniform velocity.
 - a body travelling along a circular path with uniform speed.
 - a body travelling along a circular path with non-uniform speed.
8. A lorry travelling with a velocity of 30 m/s came to rest in 5 s. What is its acceleration?
 9. What is the displacement of a car in 30 s if it is travelling with a velocity of 15 m/s?
 10. Observe the figure showing the path of a body which started from A and moved to C through B.

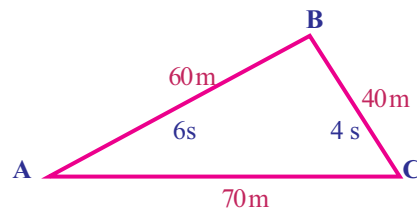

- a. Calculate the speed of the body.
- b. What is the velocity of the body?
- c. What is the velocity of the body if it has taken 5 s to reach A back from C?
- d. Compare the velocity of the body when it reached C from A and also when it reached A from C.



Extended activities

1. Find out situations in which acceleration is possible without changing the speed. Tabulate them.
2. Do vehicles travelling by your school premises obey speed limit? Find it out by undertaking a research project and present the report.
3. Organise a seminar and present a paper on 'Road Safety measures'.

4. The speed of some of the things around us is given below. Try to find out the speed of other living and non living things and expand the table.

Item	Average speed
Snail	0.0015 m/s
Cheetah	30 m/s
Supersonic plane	200 m/s
Vulture	13 m/s
Fly	
Sound in air	
Revolution of earth	



Unit
10
Force



A student entering the Headmaster's room happens to see the writings on the glass door. What do they indicate?

Let's examine.

Observe the given pictures.

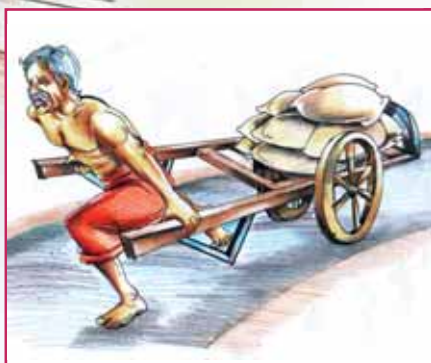

Fig. 10.1 (a)



Fig. 10.1 (b)

After analysing the pictures, tabulate the activities in them into **push** or **pull**. Add more examples to the table and expand it.

Push	Pull
• pushing a car	•
•	•

Table 10.1

When an object is pushed or pulled, a force is being applied on it.

We know that the unit of force is newton. It is indicated by the letter N.

Is force all about a push and pull? Let's examine.

Observe the pictures given below.

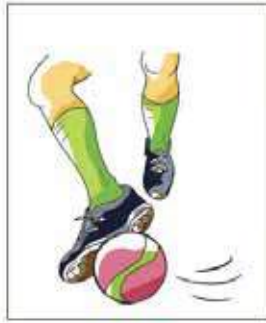

Fig. 10.2 (a)

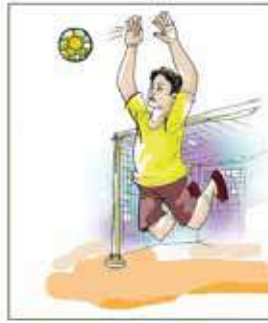

Fig. 10.2 (b)



Fig. 10.2 (c)



Fig. 10.2 (d)



Fig. 10.2 (e)



Fig. 10.2 (f)

After analysing the pictures, write down in the table below the results of applying force on different objects.

Activity	Result
<ul style="list-style-type: none"> Applying force on a rolling ball, slowly pushing it in the opposite direction with the leg. Pushing a wall 	<ul style="list-style-type: none"> The ball comes to rest. The wall has a tendency to move.

Table 10.2

From the discussions we had so far, what did you understand about force? Write it down in your science diary.

Force is that which changes or tends to change the shape, size, volume, state of rest or state of motion of a body.

Sir, Isaac Newton
(1642-1727)



He was born at Woolsthorpe in England. The laws of motion, law of gravitation etc., are among his important discoveries. He was conferred with the title 'Sir' in 1705. His famous book *philosophia naturalis Principia Mathematica* is a pioneering work in the world of Science.

One newton force

An approximate force of 1 N must be applied against the force of gravitation, to hold an object of mass 0.1 kg (100 g), parallel to the ground, in the palm.



see "Aamukham" in School Resources in IT @ School Edubuntu

Different types of forces

Man and other living creatures use muscular force to do work.

A magnet has the property of attraction and repulsion. This force, applied by a magnet, is the magnetic force.

A plastic pen when rubbed on hair can attract small pieces of paper. This is due to electrostatic force.

Objects in the universe have an attractive force between them. This attractive force is the gravitational force.

Force in relation to motion is commonly known as mechanical force. When an object moves over another object, the force which opposes the relative motion of the objects is the frictional force. In addition to these there are other forces also.

Contact Force and Non Contact Force

Observe the pictures



Fig. 10.3 (a)



Fig. 10.3 (b)



Fig. 10.3 (c)



Fig. 10.3 (d)



Fig. 10.3 (e)

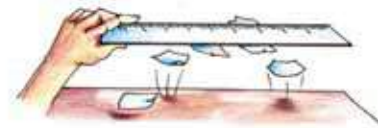

Fig. 10.3 (f)

Analyse Figure 10.3 given above and complete Table 10.3

Sl. No.	Situation	Force	
		Due to contact between objects	With no contact between objects.
1	Pushing a trolley	✓	
2	A coconut falling from a coconut tree		
3	Drawing water from a well		
4	A ball coming to rest after being rolled on a level ground		
5	A magnet attracting a nail		
6	A plastic scale rubbed on hair attracts pieces of paper.		

Table 10.3

Haven't you seen situations in which force is applied by contact and non contact?

*The force applied by the contact between objects is contact force.
The force applied on an object without contact on it is non contact force.*

Find out more examples for contact force and non contact force and tabulate them.

Contact force	Non contact force
•	•

Table 10.4

Let's examine some other ideas on frictional force which is one among contact forces of different kinds.

Frictional Force

Didn't you notice the figure?

Why do we lubricate the axle of a bicycle wheel with oil?

Roll a metal sphere or a rubber ball on a level ground.

What happens to its motion?

What may be the reason?

Discuss and write down your inferences in the science diary.

Take a look at Fig. 10.5 which shows a book placed on a table.

Tilt the table a little. Does the book move? Try to tilt the table a little more. What do you observe now? Why didn't the book move on tilting the table first?

From the figure identify the peculiarity of the surfaces of the table and the book, that come into contact. Write down your inferences in the science diary.

Haven't you noticed a large number of microscopic mounts and pits on their surfaces? When these two surfaces are in contact with each other, they get interlocked. When we try to move a body by applying a force parallel to their surfaces, an opposing force is experienced.



Fig. 10.4

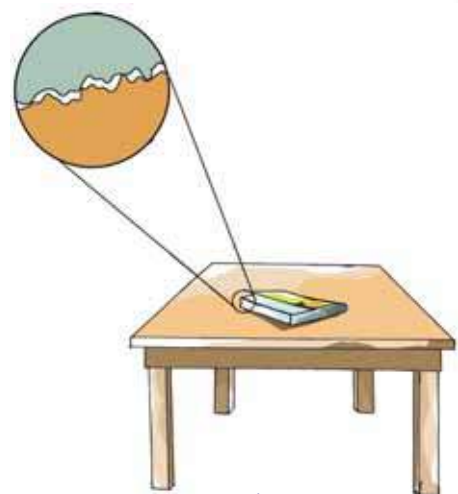

Fig. 10.5

When a body moves or tends to move on the surface of another body, a force is experienced parallel to the surface which opposes the relative motion between them. This is friction.

Is the same opposing force experienced during all contact movements between bodies? Let's examine.

Different Types of Friction

Take a look at the pictures in which two children are trying to move a log.



Fig. 10.6 (a)



Fig. 10.6 (b)

Which of these methods is easy in moving objects - by dragging or by rolling?

Let's do an experiment.

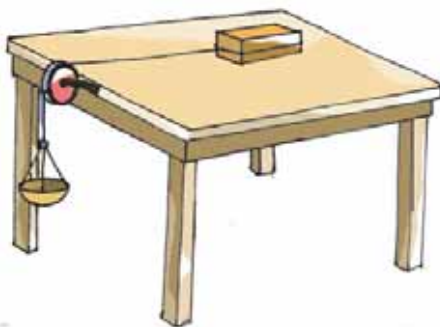

Fig. 10.7

Place a wooden block on a polished table as shown in the figure. Tie a string at one end of the wooden block and hang a pan on the other end. Allow the string to pass through a pulley. Place identical iron nails in the pan one by one. Observe the number of nails placed when the wooden piece begins to move.

Now repeat the experiment placing two cylindrical pencils between the wooden piece and the table, perpendicular to the direction of motion.

- On placing how many nails in the pan did the wooden piece begin to move?
- In which of the two situations is the force applied to move the wooden piece lesser?
- When was it necessary to apply more force, while sliding the wooden piece or while rolling it over the pencils?
- If so, in which situation is the opposing force less?



See 'gharshanam undakunnathengane' in School Resources in IT @ School Edubuntu.

When a body rolls over the surface of another body, the force of friction which originates is rolling friction. When a body slides on the surface of another body the force of friction which originates is sliding friction. Rolling friction is less than sliding friction.

Wheels are used in vehicles to reduce friction. Identify situations where there is a reduction of friction as a result of rolling and write them down in your science diary.

Friction is used in many situations in our daily life. Nevertheless friction has some disadvantages too. Given below are some situations where friction is beneficial and non beneficial. Tabulate them.

- striking a match stick on the side of a match box.
- wear and tear of machines.
- ability to hold objects
- walking
- treading of tyres of vehicles
- wearing out of tyres
- fuel loss



See "gharshanam prayojanappeduthunnu" in School Resources in IT @ School Edubuntu.

Situations where friction is beneficial	Situations where friction is non beneficial

Table 10.5

Find more situations and expand Table 10.5

You might have understood that there are advantages and disadvantages of friction. What are the different methods to reduce friction? Let's examine.

Observe the pictures given below.



Fig. 10.8 (a)



Fig. 10.8 (b)



Fig. 10.8 (c)

Why are they designed in a peculiar shape? Discuss.

Don't you think this reduces the friction due to air, water or both when they move forward?

Designing the shape of objects so as to reduce friction is Streamlining.

Haven't you noticed oil being applied to a pulley used to draw water from a well and oil or grease being applied in the moving parts of vehicles. What is the advantage of doing so?

Such materials used to reduce friction are the lubricants. Graphite is a solid lubricant.

List out other materials used as lubricants.

- coconut oil
-

Have you noticed bearings being used to reduce friction between the surfaces of contact of moving parts of machines? Here the principle that rolling friction is less than sliding friction is made use of. Are there other methods to reduce friction? Friction is also reduced by polishing surfaces. From what you have understood so far, state the methods adopted to reduce friction.

- use lubricants.
-

Are you familiar with any other forces experienced in daily life?

Thrust and Pressure

Did you notice the conversation?

Let's examine what it means.



Needle bearing
Fig. 10.9 (a)



Ball bearing
Fig. 10.9 (b)



See "gharshanam kurackunna reethikal" in School Resources in IT@ School Edubuntu



Let's do the activity given.

Take some powdered lime in a tray. Place a previously weighed brick on it as shown in Figure 10.10 (a).

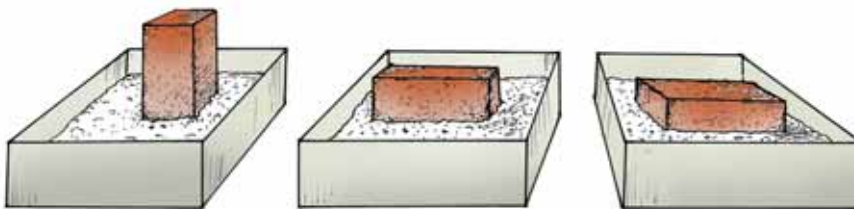

Fig. 10.10 (a)

Fig. 10.10 (b)

Fig. 10.10 (c)

Note down the results of the experiment in Table 10.6. Now, place the brick as shown in the other figures and complete the table by writing down the result of the experiment.

The manner in which brick is placed on powdered lime.	Depression resulting in powdered lime.	Weight of the brick or the force experienced vertically (F)	The area of contact of brick with powdered lime (A)	The vertical force exerted by the brick on unit area $P = \frac{F}{A}$
Vertical				
Horizontal				
with broader side downward				

Table 10.6

Blaise Pascal



He was born in France on 19 June 1623. He made many contributions to the field of Mathematics and Physics. The law discovered by him in relation to pressure is known as Pascal's law. The unit of pressure, pascal, was named after him. Pascal died on 19th August 1662.

- What will be the total force the brick exerted on the lime powder whichever way it is placed?
- Is the amount of force exerted by the brick on unit area always the same?

From your findings, haven't you understood that the total force experienced by a surface and the total force per unit area experienced by it are different?

The total normal force experienced by a surface is thrust.

Thrust per unit area is pressure.

$$\text{Pressure} = \frac{\text{Thrust}}{\text{Area}}$$

From this equation we can conclude that the unit of pressure is N/m². This is known as pascal.

Weight

Weight is the attractive force exerted by the earth on an object. Weight of an object of mass m kg is $F=mg$. Here g =acceleration due to gravity = 9.8 m/s^2 .

Is there a difference in total force exerted by the brick in all situations in the experiment you have done.

Which is the surface of the brick having the minimum area of contact?

In which arrangement of the brick, does it produce a deeper depression in powdered lime?

Is the depth of depression on placing the brick on its broadest area in lime powder more or less, compared to the depression produced when it was placed on other surfaces?

Discuss your findings with your friends. Find out the relation between pressure and area of contact of an object and write them down in your science diary.

From Table 10.6, you might have understood that variation in pressure takes place according to the area of surface in contact.

While applying a given force, pressure decreases when the area of surface of contact increases. When the area decreases the pressure increases.



Fig. 10.11

Now you might have understood what it means to be able to lie on a bed of nails.

Given below are certain situations in which variation in pressure is brought about by increasing or decreasing the area of surface. Explain how these are useful.



Fig. 10.12

- constructing a knife with a sharp edge.
- constructing buildings with wider basements.
- connecting the wheels of tanks and other such vehicles using wide chains.
- making a sewing needle with a sharp tip.

Is pressure exerted by solid objects alone? Let's examine.

Liquid Pressure

Fix identical balloons A, B, C on a PVC pipe as shown in Figure 10.13. Observe the expansion of balloons on filling water in the pipe.

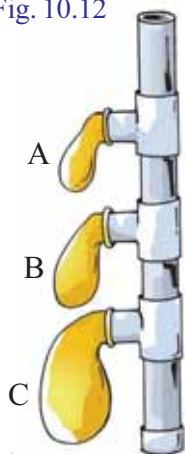

Fig. 10.13

- Which balloon has expanded more?
- What may be the reason?

- How can the expansion of balloon be related to the depth of the level of liquid in the pipe?

Haven't you understood that the pressure experienced in liquids depend on the height of the liquid column above it? Pour more water in the pipe to raise the water level in it. Haven't you understood why the balloons expanded more?

The pressure exerted by a liquid column increases with increase in height.

The thrust acting per unit area by a liquid is liquid pressure.

Liquids exert force on all sides of the container in which they are taken.

Haven't you seen that the height of the liquid column influences the pressure exerted by it? Try to do one more experiment.

Firmly fix two identical balloons at the lower ends of two identical PVC pipes as shown in Figure 10.14.

Now fill one of the pipes with water and the other with kerosene.

- What do you observe?
- Why is the expansion of balloons different? Discuss.

From the experiments we have done so far, let's list the factors influencing liquid pressure:

- height of the liquid column (h)
- density of the liquid (d)

In other words, liquid pressure is directly proportional to the weight of liquid column over unit area.

If the height of the liquid column is 'h', density of liquid 'd' and acceleration due to gravity 'g', then liquid pressure is $P = hdg$

Can gases exert pressure similar to liquids? Let's examine.

Atmospheric Pressure

Burn a few pieces of paper and put it in a tall glass bottle. Peel a fully ripe banana a little and place it at the mouth of the bottle, when the paper has almost burnt. What do you observe? What might be the reason?

- What happens to the pressure of air inside the bottle when the paper burns?

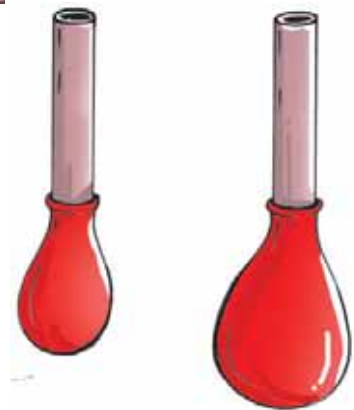

Fig. 10.14



Fig. 10.15



Story of a tug of war



The existence of atmospheric pressure was proved by Ottovon Guericke of Mugdiberg. He connected two hemispheres made of copper using a ring. The air inside them was then pumped out. Eight horses each, tied to either ends of the hemisphere, could not pull it apart. Since the inside of a hemisphere is vacuum, the pressure is low. This is because atmospheric pressure is greater outside.

- Will the air inside the bottle get expelled when the pressure inside it increases and expands?
- How is the pressure of air inside the bottle after the mouth of the bottle is shut by the banana? Find the answer by comparing it to atmospheric pressure.
- What happens when the bottle gets cooled?

Since the atmospheric pressure outside the bottle is greater than the pressure of air inside it, the banana slips into the bottle. From this experiment you might have understood that atmospheric air can exert pressure.

An envelope of air surrounds the earth. This is the earth's atmosphere. The density of atmospheric air near the surface of the earth is greater and it decreases as we go up. Hence atmospheric pressure decreases as we go up.

The weight of the air column over unit area of the earth's surface is atmospheric pressure.

List the situations in daily life where atmospheric pressure is used.

- drinking juice using a straw.
-

A few statements related to atmospheric pressure are given below.

Discuss and write down the reasons in your science diary.

- Astronauts wear specially designed clothes.
- As mountaineers climb higher altitudes there is the possibility of nasal bleeding.
- Fixing rubber suckers on polished surfaces.

Let's measure atmospheric pressure

The weight of an air column above unit area on the surface of earth at sea level is considered as one atmospheric pressure. This is equivalent to the weight of Mercury column of height 0.76 m and unit area of 1m^2 . This is Standard atmospheric pressure. The unit of atmospheric pressure is bar.

The instrument used to measure atmospheric pressure is Barometer.



Fig. 10.16



Barometer
Fig. 10.17



Significant learning outcomes

The learner can

- explain what force is and what the results of applying a force are.
- identify different types of forces and classify them into contact and noncontact forces.
- explain friction and identify its advantages and disadvantages and use it in daily life situations.
- explain thrust and pressure.
- use the relation between area and pressure in appropriate situations.
- explain liquid pressure and engage in experiments that show the relation between pressure and height.
- explain what atmospheric pressure is and use it appropriately in daily life situations.



Let us assess

1. Classify the following situations into contact and noncontact forces.
 - a. Applying break in a bicycle.
 - b. A mango falling from a mango tree.
 - c. The earth revolving around the sun.
 - d. The speed of a ball rolling on ground is reduced.
2. State reason
 - a. We are able to walk on the ground without slipping.
 - b. It is easy to cut vegetables using a sharp knife.
 - c. The number of tyres is more for goods vehicles.
 - d. The moving parts of machines experience wear and tear.
3. Match the following

A	B	C
Atmospheric pressure	pascal	coconut oil
Lubricant	attraction	barometer
Coconut falling down	bar	thermometer
Magnet	friction	noncontact
	gravitation	repulsion

4. Bubbles rising from the bottom of the water filled in a bottle are depicted in the figure. Which is the correct figure? Justify your answer.

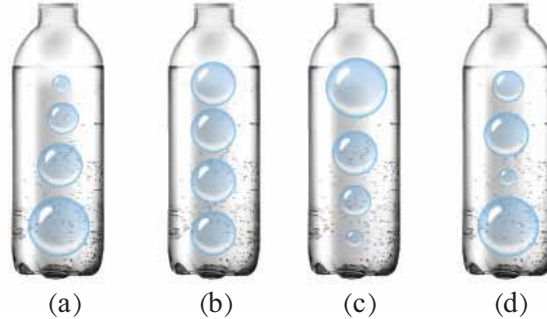

5. A toy car of about 50 g placed on a polished table with threads attached to it carrying two pans passed through two pulleys, is depicted.

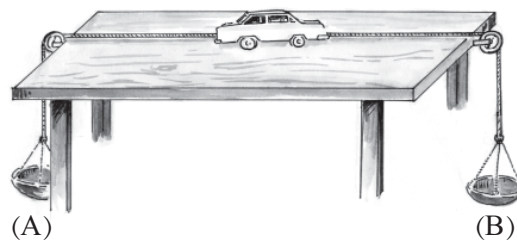

- (a) What do you observe if 100 g each is placed on both pans?
 (b) What do you observe if 100 g is placed on pan A and 200 g in pan B
 (c) Justify your answers.



Extended activities

1. When area increases, pressure decreases. Find situations where this principle is applied.
2. Find the disadvantages of friction in our daily life and suggest remedy.
3. Organize, carryout and form inferences of an experiment to prove that the frictional force exerted by different surfaces are different.



Unit
11

Magnetism



“This train has no wheels. How does it run then?

Isn't it surprising?”

Sister asked, watching the scene of a speeding Maglev train on Television.

Do you know how this train runs?

You might have done many experiments using magnets. Try to write down some of them.

- Separating of iron dust from sand.
-

Haven't you seen toys that make use of magnets? List the situations where magnets are used in this manner.

- Toy car
-

Are objects having magnetic power available in nature?



Lodestone

Magnetic properties of substances have been known to people from ancient times. In 800 BC, a particular mineral discovered in a place named Magnesia, was found to possess an amazing property. They could attract pieces of iron. Considering this feature of the mineral it was given the name 'magnetite'. When suspended freely, the pieces of this mineral were found to indicate a particular direction. They came to be known as leading stone (load stone or lodestone) as they exhibited this property. Magnets like these, found in nature, are natural magnets.

Natural Magnets and Artificial Magnets

Magnets obtained directly from nature are natural magnets.

Nowadays artificial magnets are used commonly. Haven't you understood that they are made of alloys like alnico? Some magnets known to us on the basis of their shapes are depicted in Table 11.1.

Try to identify the artificial magnets given in the table and write them down in the space given.





Shape of magnet	Name of magnet
	
	Magnetic needle
	
	
	

Table 11.1

Let's see what the general properties of magnets are.

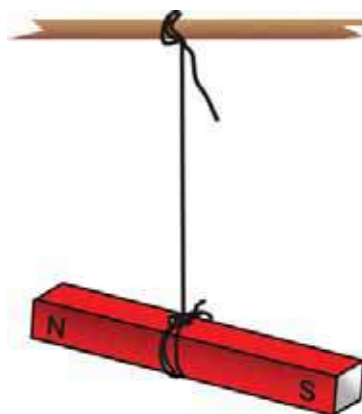

Fig. 11.1

Suspend a magnet using a thread, as shown in Fig. 11.1, in such a way that it is free to turn.

In which direction of the earth does the end marked 'N' point when the suspended magnet come to rest?

And what about the end marked 'S' on the magnet?

If a magnet is arranged in such a way that it can move freely (like suspending it using a thread) it will align itself in the north south direction of the earth. It is because a magnet possesses directional property that a freely moving magnet always aligns itself in the north south direction. The end of the magnet pointing to the north is the North Pole (N) and the other end is the South Pole (S).

Bring the north pole of another magnet close to the north pole of the magnet in the former experiment. What do you observe? What if you bring the south pole at the same end? Write down your observations in the science diary.

As far as magnets are concerned, like poles repel each other and unlike poles attract each other.

Place two strong bar magnets between the refills fixed on a piece of thermocol as shown in Figure 11.2.

Why does the second magnet float in air?

What poles would the ends C and D be when the bar magnet floats in air? Note down.

Do you think it is possible to move the magnet on the top with magnet at the bottom without causing any friction?

What do you observe when you bring the south pole of another magnet close to the north pole of the magnet at the top? And what if we bring the north pole of the magnet instead? Is frictional force experienced when the magnet at the top moves in both these situations?

Now can't we explain how Maglev trains move without wheels and friction?

Magnetic Compass

Are you familiar with any instrument which makes use of the directional property of magnet?

What do you think, the instrument shown in Figure 11.3, is used for?



Fig. 11.3

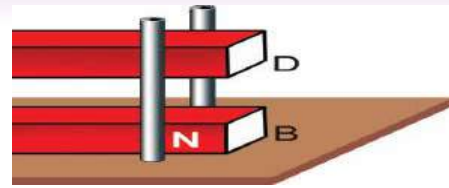

Fig. 11.2



Maglev trains

You might have been fascinated by the sight of trains speeding along railway lines. The noise produced by fast rolling metal wheels on rails is perhaps annoying. Maglev trains or Magnetic Levitation trains are trains without wheels that move fast over the rails.



It is the interaction between the magnetic field created by electromagnets at the bottom of the train and the magnetic field resulting from the arrangement of rails that the train rises a little above and moves forward fast.

As the movement is one where there is no contact between the train and rails, both energy loss due to friction and noise pollution are minimised considerably. They are vehicles that move fast silently and easily with less wear and tear.

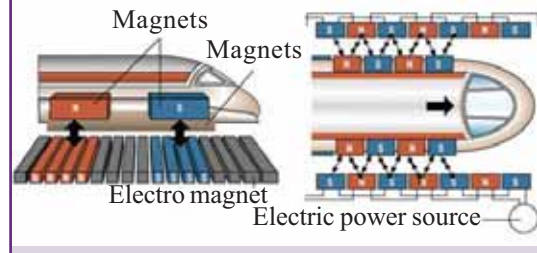

Compass is a magnetic needle arranged in such a way that it can rotate freely inside an aluminium or plastic case. When placed on a horizontal surface the magnetic needle in it comes to rest quickly in the north- south direction. Hence this instrument is used to find the direction.

On the basis of the lesson, write down the method adopted in ancient times by sailors on ships and travellers in the desert to reach their destination.

Haven't you seen that a bar magnet suspended on a string lies in the north south direction? Why don't the ends come in other directions?

Earth as a Magnet

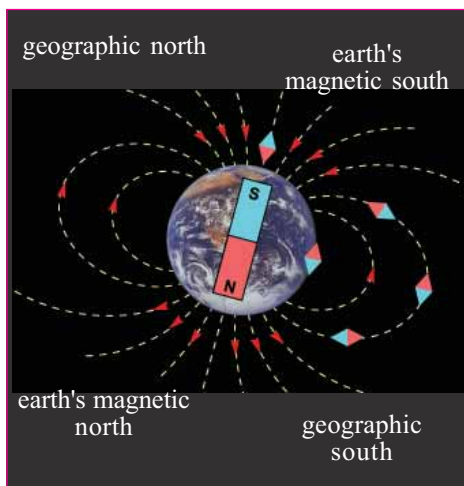

Fig. 11.4



See 'magnet and compass' in PhET of IT@ School Edubuntu

The earth acts like a large magnet. This was first discovered by the scientist William Gilbert. He found out that just as the earth has north and south geographically, it has the north pole and the south pole when considered as a magnet.

- Towards which pole of the earth's magnet does the North Pole of the suspended magnet point?
- What about the south pole of the bar magnet?

The south pole of the earth's magnet is near the geographic north pole and the north pole of the earth's magnet is near the geographic south pole. (Figure 11.4)

From the ideas you have gathered, write down in your science diary why a freely suspended bar magnet using a thread always align itself in the north south direction. Isn't it a property of magnets? Let's have a look at the other properties of magnets.

Let's magnetise a hacksaw blade.

How does magnetisation occur?

Place the hacksaw blade AB on a table. Rub the north pole of the bar magnet NS starting from the end A to the end B of the blade, as shown in fig.11.5. Repeat it several times in the same manner. The hacksaw blade changes into a magnet with the end A as the north pole and the end B as the south pole.

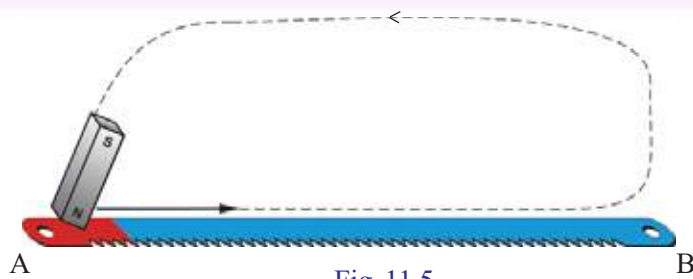

Fig. 11.5

Bring the end A (north pole) of the magnetised hacksaw blade near the north pole of a magnetic needle. What do you observe? Now, break a small portion of the hacksaw blade from near the north pole carefully. Will there be a north pole at the remaining end? Examine this using a magnetic needle. Record your findings in your science diary.

See if it is possible to break the end of the blade again and again carefully, till the south pole alone is left. What is your inference?

Bring both ends of the broken pieces near the magnetic needle and observe what happens. Write down your inference in the science diary.

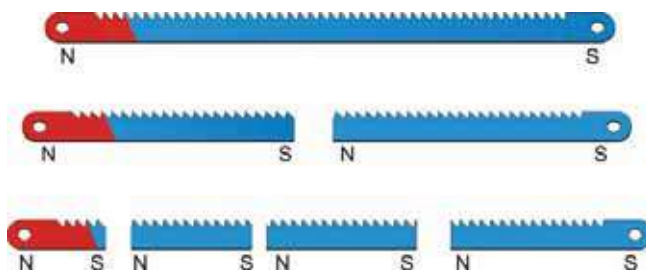

Fig. 11.6

Every magnet, however small it may be, has two poles. Making a monopole magnet has not yet been possible.

Won't a magnet attract a magnetic substance when brought close to it?

How can we find the region around a magnet where the influence of the magnet is felt?

Magnetic field

Fix a drawing sheet of size about 30 cm length and 30 cm breadth on a surface. Place a compass in the middle of the drawing sheet. Mark the north and south poles of the magnetic needle on the paper. Draw a straight line

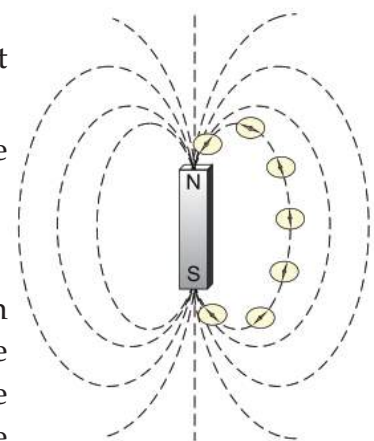

Fig. 11.7

connecting these points in the north south direction. Keeping this line in the north south direction, place a bar magnet in the middle so that its north pole points towards the north of the earth. Trace the boundary NS of the bar magnet on the paper (Fig.11.7). Bring a magnetic compass near the north pole.

Which end of the magnetic needle does the north pole of the magnet attract? Note down.

Mark a dot on the paper near the free end of the north pole of the magnetic needle. Now change the position of the compass such that its centre falls on the dot. Mark the position of the north pole of the compass needle. Repeat the process. Didn't you get a large number of points on the paper? Draw a line joining these dots. This is an imaginary line indicating the influence of magnetic force and its direction. Such a line is the magnetic line of force.

Repeat the process a number of times placing the compass at different positions near the north pole of the magnet and draw more magnetic lines of force extending upto the south pole. Do all the lines of force reach the south pole of the magnet? Haven't you observed that the direction of magnetic lines of force is from the north pole to the south pole outside the magnet? It is considered to be from the south pole to the north inside a magnet. Is the distribution of magnetic lines of force the same everywhere? In the figure you have drawn, where do you see the magnetic lines of force close to one another? Write it down.

Magnetic Flux Density

Are magnetic lines of force present in all dimensions around a magnet? Let's do an experiment.

Using a thread suspend a bar magnet as shown in Fig. 11.8. Now bring the needle of a magnetic compass to different positions around its north and south poles. What do you observe?

Isn't the influence of the magnetic force experienced in all positions? We understand the presence of magnetic lines of force from this. What is your inference? Write it down.

Magnetic lines of force are experienced in all dimensions around a magnet.

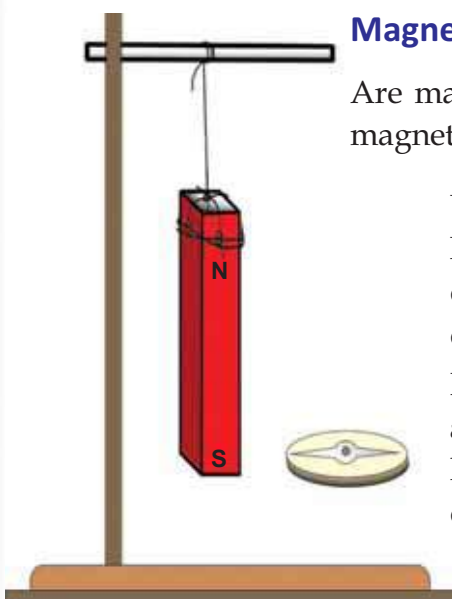

Fig. 11.8

Let's imagine the magnetic lines of force as a cage around a magnet. The number of magnetic lines of force passing normal to unit area is the magnetic flux density of that region.

Magnetic flux density is greater at the poles of a magnet. What are the peculiarities of magnetic lines of force?

By means of an experiment using a magnetic needle, draw the magnetic lines of force formed between magnets, as in Fig. 11.9(a).

Now place the north pole of one magnet near the south pole of another magnet and try to draw the magnetic lines of force between them as in Fig. 11.9(b).

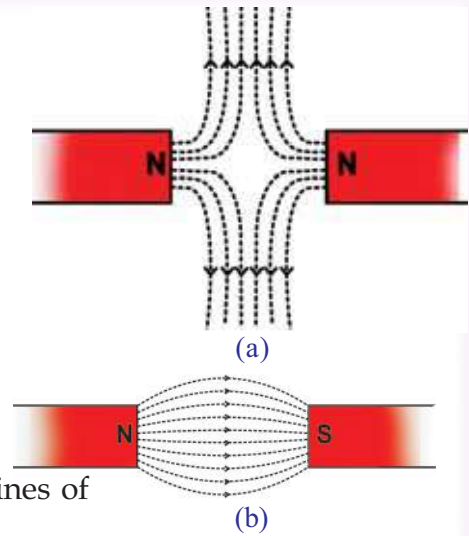

Fig. 11.9

From the drawing you have made, find out the peculiarities of magnetic lines of force and write them down in your science diary.

- Magnetic lines of force do not intersect one another.
- Magnetic lines of force bend sideways, when like poles of magnets come near each other.
- When unlike poles of magnets come close to each other, the path of the magnetic lines of force is from the north pole of one magnet to the south pole of the other magnet.

Magnetic force is experienced in all dimensions around a magnet. This region around a magnet where the influence is felt is the magnetic field.

You have understood that a magnet attracts magnetic substances.

Make a list of substances attracted by a magnet.

- cobalt
- nickel
-

Does a magnetic substance attracted by a magnet get a magnetic force?

Magnetic Induction

Bring a pin in contact with the pole of a bar magnet as shown in Fig. 11.10. Is it not attracted? What if you bring another pin to the free end of the pin? What is

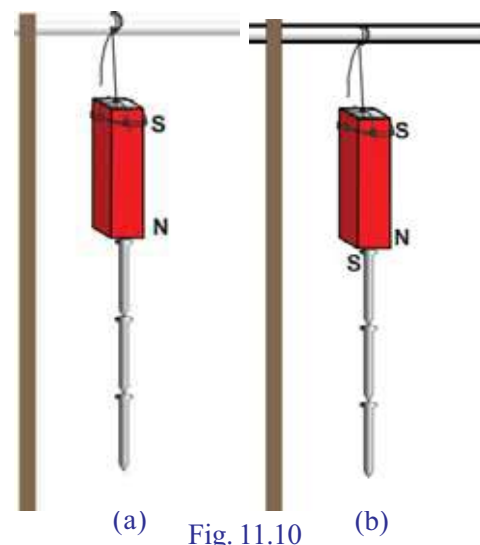

(a) Fig. 11.10 (b)

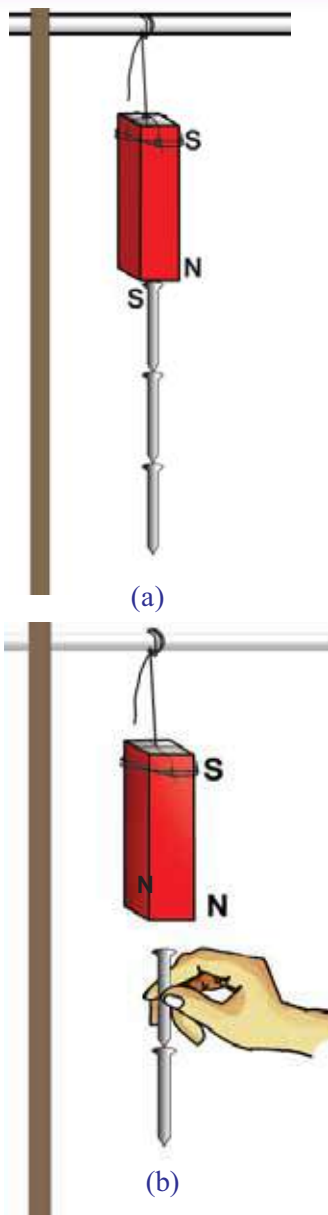

Fig. 11.11

the basis of attraction of the second pin to the first? Write it down on the basis of the attraction – repulsion law. How many pins can you hang like this? Try it out.

Why do you think you can hang more pins in this manner? Write down your inference in the science diary. How will the magnetic polarity of each pin be? Find it out analysing Fig.11.11 (a) and present it.

Hold the topmost pin and carefully take away the magnet. What do you observe? Why did some pins fall down? Discuss.

Examine how many pins could be kept attracted to each other by holding a pin without touching the magnet, as shown in Fig. 11.11(b)? What may be the reason for this?

What change occurs in the arrangement of the pins when the magnet is removed? Why did the pins fall down? Write it down.

The phenomenon of a magnetic substance acquiring magnetism due to the presence of a magnet is Magnetic Induction. The magnetic force acquired by the magnetic substance is the Induced Magnetism.

Let's see how magnetic poles are developed in a magnetic substance due to magnetic induction.

You might have understood that the pins attached to the poles of a magnet change into magnets. Identify the pole at the tip of the pin touching the north pole of the magnet. Examine by bringing a magnetic needle near the free end of the pin as in Fig. 11.12 (a). Write down the polarity of the free end. Hold

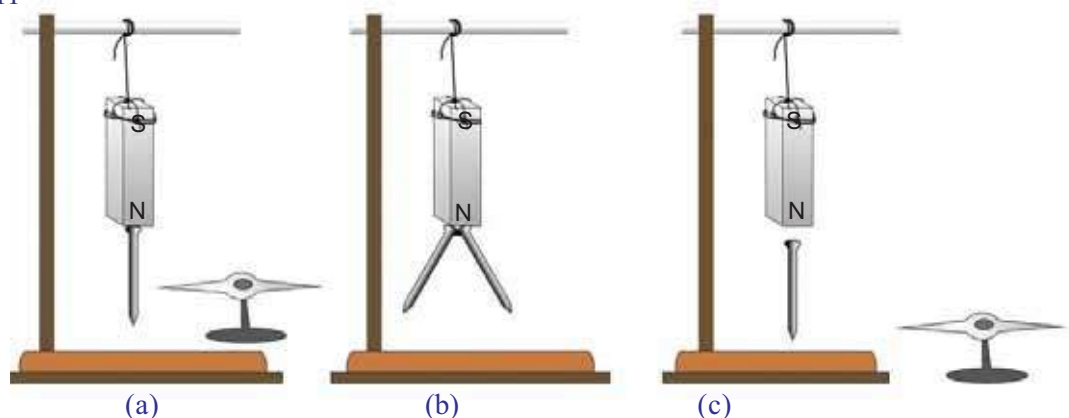

Fig. 11.12

two pins together close to the north pole of the magnet. How do the free ends remain? Mark the polarity of the free ends in Fig.11.12 (b).

Now bring the pin near one of the poles of the magnet as shown in Figure 11.12 (c).

Haven't we learnt that the pin changes into a magnet? Examine using a magnetic needle, the magnetic pole formed at the farthest end of the pin. We find that the polarity developed at the farthest end is the same as that of the tip of the magnet, with which the pin is in contact. What are the inferences you arrive at from the experiments? Write it down.

Whether under contact or without contact, the polarity of the magnet produced by induction will be like polarity at the farther end and unlike polarity at the nearer end.

Magnetic Induction in Soft Iron and Steel

Place a soft iron piece on any one pole of a bar magnet as shown in Fig.11.13. Thrust the free end of the iron piece in a heap of pins and take it out. Count the number of pins that get attracted? Holding the soft iron piece, remove the bar magnet. What do you observe? Why did all the pins fall down?

Repeat the experiment using a piece of steel of the same size instead of the soft iron piece. Count the number of pins that get stuck onto the piece of steel and write it down.

What do you observe on removing the bar magnet? Do all pins fall down? What is the reason? Here both soft iron and steel get magnetised when placed in a magnetic field.

- Which of these has greater susceptibility?
(Soft iron/Steel)
- Which of these has greater retentivity?
(Soft iron/Steel)

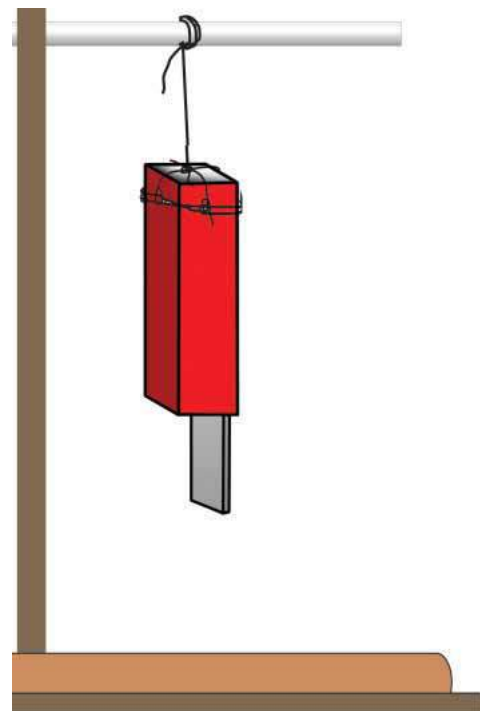

Fig. 11.3

Susceptibility and Retentivity

The ability of magnetic substances to get magnetised under the influence of a magnetic field is Susceptibility. Retentivity is the ability to retain the magnetism thus acquired.

On the basis of properties you have identified, which is suitable for making strong temporary magnets? soft iron or steel? Write down which magnetic property of steel is used for making permanent magnets.

Soft iron	Steel
<ul style="list-style-type: none"> The ability to retain magnetism acquired (retentivity) is very low. 	<ul style="list-style-type: none">
<ul style="list-style-type: none"> 	<ul style="list-style-type: none"> Is not easily subjected to magnetic induction. In other words, its susceptibility is very low.

Table 11.2

Permeability

Place an iron ring or a large iron nut between the poles of two magnets as shown in Figure 11.14. Place a thin glass plate above them and sprinkle iron filings on it. Tap gently on the glass plate. What do you observe? Do the iron filings stick to the hollow part of the nut?

Compare the pattern you got with the one given in the figure. What inference do you arrive at?

The ability of soft iron to permit magnetic lines of force pass through it is greater than that of air. That is, magnetic lines of force pass more easily through soft iron than through air.

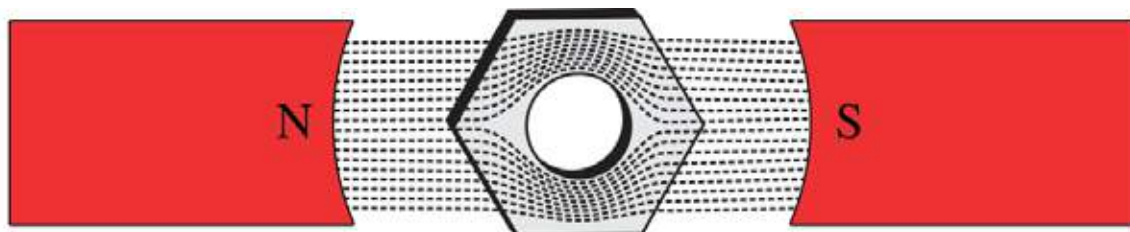

Fig. 11.15

Permeability is the ability of substances to pass magnetic lines of force through them.

On the basis of your findings can you suggest a method to increase flux density at a point in a magnetic field?

The magnetic compass is not made by arranging magnetic needle inside a soft iron case. Why?

Magnetic needles are usually artificial magnets. Alloys are used to make artificial magnets. How do you make strong magnets using these alloys?

Electromagnet

Wind a few turns of insulated copper wire on an iron nail. Connect the ends of the wire to a cell. Bring some pins near the nail. What do you observe? Why does the nail attract the pins?

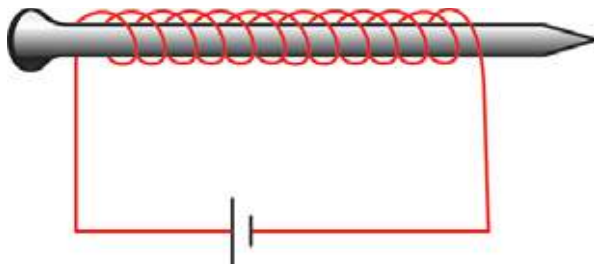

Fig. 11.15

Repeat the experiment increasing the number of turns of wire, increasing the number of cells and using more than one nail held together. Write down your findings in the science diary.

Electromagnets can be made by passing electric current through insulated copper wire wound on a soft iron piece.

The strength of electromagnets made in this way depends on

- *the number of turns of coiled conductor*
- *the strength of current*
- *the area of cross section of the soft iron placed inside the coil.*

All electromagnets are temporary magnets. If the current ceases to flow, the magnetism of the soft iron core is lost.

Repeat the experiment using a steel nail instead of the soft iron nail. Is the magnetism of the steel nail lost on stopping the supply of current? Examine. Write down your findings in the science diary.

On the basis of the experiments you have carried out, you might have understood that permanent magnets of different shape and strength can be made.



Significant learning outcomes

The learner can

- explain with the help of experiments the fact that like poles repel each other and unlike poles attract each other.
- explain the directional property of a magnetic compass and use it appropriately in required situations.
- explain the magnetic properties of the earth with the realisation that the earth behaves like a bar magnet.
- explain magnetic field, magnetic lines of *force*, flux density, magnetic induction, etc.
- conduct different experiments related to magnets.
- understand and explain differences in the magnetic properties of soft iron and steel.
- explain methods for increasing the strength of an electromagnet.
- explain methods to make permanent magnets of different shapes artificially.



Let us assess

1. In the figure, AB is a bar magnet. CD is a soft iron rod placed near the end B. Write down which poles develop at the ends C and D .

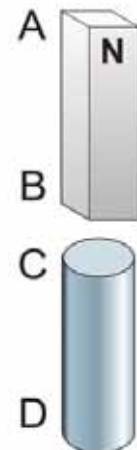

2. Figures A and B show two iron nails each hanging from a bar magnet and a U shaped magnet.
- (a) Identify the correct picture in A and B.
- (b) Justify your answers.

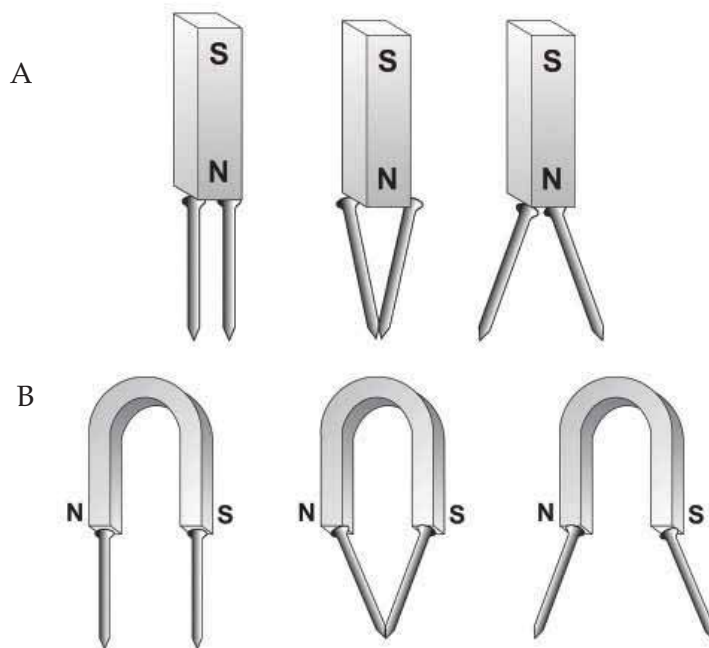

3. You are given a soft iron piece, a steel piece of the same size, insulated copper wire and a battery.
- (a) Explain how a strong permanent magnet can be made.
- (b) Suggest a method to make a temporary magnet.
4. Can you build a compass and make it work by arranging a magnetic needle in such a way that it rotates freely inside an iron case? What is the reason?
5. In an exhibition, a plastic car with an iron piece fixed inside it is made to run on a wooden table by sliding a strong magnet below it. The experiment failed when a steel table was used instead. Explain the reason.



Extended activities

1. Take six ferrite ring magnets. Pass two of them through a pencil and fix as shown in the figure. Take a thick sheet of thermocol. Fix two ring magnets in each groove in such a way that the distance between the ring magnets on the pencil and the magnets fixed on the thermocol are the same. Arrange them in such a way that the sharp end of the pencil touches on a plastic or hylum sheet fixed vertically. Turn the other end of the pencil slightly. What do you observe? Prepare your observation notes.

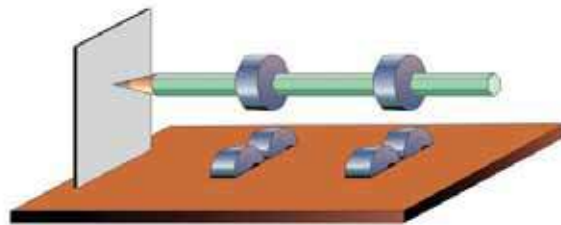

2. Collect five small identical disc magnets. Place each of the magnets in each lid of mineral water bottles in such a way that the north pole faces down. Place the lid one by one in water filled in a plastic basin. Write down your observations and state the reason behind them.
3. We prepared the map of magnetic flux lines by conducting an experiment placing the north pole of a magnet pointing in the north direction. Now place the north pole of the bar magnet pointing in south direction and mark the magnetic flux lines. Observe the difference between the maps.



PERIODIC TABLE

Key		Atomic Number Symbol Malayalam Name English Name Latin/Greek name																																																																																																																			
	Gases		Liquids																																																																																																																		
	Synthetic Elements																																																																																																																				
1 H ഹൈഡ്രജൻ Hydrogen	2 He ഹീലിയം Helium	3 Li ലിഥിയം Lithium	4 Be ബെരിലിയം Beryllium	5 B ബോറോൺ Boron	6 C കാർബൺ Carbon	7 N നൈട്രജൻ Nitrogen	8 O ഓക്സിജൻ Oxygen	9 F ഫ്ലൂറിൻ Fluorine	10 Ne നിയോൺ Neon	11 Na സോഡിയം Sodium (Natrium)	12 Mg മഗ്നീഷ്യം Magnesium	13 Al അലൂമിനിയം Aluminium	14 Si സിലിക്കൺ Silicon	15 P ഫോസ്ഫറസ് Phosphorus	16 S സൾഫർ Sulphur	17 Cl ക്ലോറിൻ Chlorine	18 Ar ആർഗോൺ Argon	19 K പൊട്ടാസ്യം Potassium (Kalium)	20 Ca കാൽസ്യം Calcium	21 Sc സ്കാൻഡിയം Scandium	22 Ti ടൈറ്റാനിയം Titanium	23 V വാനേഡിയം Vanadium	24 Cr ക്രോമിയം Chromium	25 Mn മാംഗനീസ് Manganese	26 Fe ഇരുമ്പ് Iron (Ferrum)	27 Co കോബാൾട്ട് Cobalt	28 Ni നിക്കൽ Nickel	29 Cu കോപ്പർ Copper (Cuprum)	30 Zn സ്നക് Zinc	31 Ga ഗാലിയം Gallium	32 Ge ജർമ്മേനിയം Germanium	33 As ആർസെനിക് Arsenic	34 Se സെലീനിയം Selenium	35 Br ബ്രോമിൻ Bromine	36 Kr ക്രീപ്റ്റോൺ Krypton	37 Rb റൂബിഡിയം Rubidium	38 Sr സ്ട്രോന്ത്യം Strontium	39 Y യീട്രിയം Yttrium	40 Zr സിറോണിയം Zirconium	41 Nb നിയോബിയം Niobium	42 Mo മോഡ്ബേ- നിയം Molybdenum	43 Tc ടെക്നീറ്റിയം Technetium	44 Ru റൂഥേനിയം Ruthenium	45 Rh റോഡിയം Rhodium	46 Pd പാലേഡിയം Palladium	47 Ag സിൽവർ Silver (Argentum)	48 Cd കാഡ്മിയം Cadmium	49 In ഇൻഡിയം Indium	50 Sn സ്റ്റീൻ Tin (Stannum)	51 Sb ആന്റിമോണി Antimony (Stibium)	52 Te ടെല്ലൂറിയം Tellurium	53 I ഓഡയൻ Iodine	54 Xe നിയോൺ Xenon	55 Cs സീസിയം Caesium	56 Ba ബാരിയം Barium	57 La ലാന്ഥാനം Lanthanum	58 Ce സെറിയം Cerium	59 Pr പ്രോമീറ്റിയം Praseodymium	60 Nd നിയോബിയം Neodymium	61 Pm പ്രോമീറ്റിയം Promethium	62 Sm സമേരിയം Samarium	63 Eu യൂറോപ്പിയം Europium	64 Gd ഗാഡോളിനിയം Gadolinium	65 Tb ടെർബിയം Terbium	66 Dy ഡിസ്പ്രോസിയം Dysprosium	67 Ho ഹോളിമിയം Holmium	68 Er എർബിയം Erbium	69 Tm ത്ഥൂലിയം Thulium	70 Yb യുബേർബിയം Ytterbium	71 Lu ലൂത്സിയം Lutetium	72 Hf ഹാഫ്നിയം Hafnium	73 Ta ടാണ്ടാലം Tantalum	74 W ടങ്സ്റ്റൻ Tungsten (Wolfram)	75 Re റേനിയം Rhenium	76 Os ഓസ്മിയം Osmium	77 Ir ഇർഡിയം Iridium	78 Pt പ്ലാറ്റിനം Platinum	79 Au സോൾഡോ Gold (Aurum)	80 Hg മെർക്കുറി (Hydrargyrum)	81 Tl ത്വാലിയം Thallium	82 Pb ലോഡ് Lead (Plumbum)	83 Bi ബിസ്മത്ത് Bismuth	84 Po പോളോണിയം Polonium	85 At അസ്റ്റാറ്റിൻ Astatine	86 Rn റേഡോൺ Radon	87 Fr ഫ്രാൻസിയം Francium	88 Ra റേഡിയം Radium	89 Ac ആക്റ്റീനിയം Actinium	90 Th തോറിയം Thorium	91 Pa പ്രോട്ടാക്റ്റിനിയം Protactinium	92 U യുറേനിയം Uranium	93 Np നെപ്റ്റ്യൂനിയം Neptunium	94 Pu പ്ലൂട്ടോനിയം Plutonium	95 Am അമേരിക്കിയം Americium	96 Cm ക്യൂർനിയം Curium	97 Bk ബെർക്കലിയം Berkelium	98 Cf കാലിഫോർനിയം Californium	99 Es ഐസ്റ്റീനിയം Einsteinium	100 Fm ഫെർമിയം Fermium	101 Md മെൻഡീലീവിയം Mendelevium	102 No നോബെല്ലിയം Nobelium	103 Lr ലോറന്ത്യം Lawrencium	104 Rf റൂഥേർഫോർഡിയം Rutherfordium	105 Db ഡബ്ലിയൂ Dubnium	106 Sg സിബർഗിയം Seaborgium	107 Bh ബോർഹിയം Bohrium	108 Hs ഹാസ്സിയം Hassium	109 Mt മീറ്റ്നിയം Meitnerium	110 Ds ഡാമസ്റ്റാഡിയം Darmstadtium	111 Rg റോന്റേജിയം Roentgenium	112 Cn കോപ്പർനിയം Copernicium	113 Uut യൂനൂനിയം Ununtrium	114 Fl ഫ്ലോറിയം Flerovium	115 Uup യൂനൂപെന്ത്യം Ununpentium	116 Lv ലീവർമോറിയം Livermorium	117 Uus യൂനൂസെപ്റ്റിയം Ununseptium	118 Uuo യൂനൂഓക്ടിയം Ununoctium

58 Ce സീസിയം Cerium	59 Pr പ്രോമീറ്റിയം Praseodymium	60 Nd നിയോബിയം Neodymium	61 Pm പ്രോമീറ്റിയം Promethium	62 Sm സമേരിയം Samarium	63 Eu യൂറോപ്പിയം Europium	64 Gd ഗാഡോളിനിയം Gadolinium	65 Tb ടെർബിയം Terbium	66 Dy ഡിസ്പ്രോസിയം Dysprosium	67 Ho ഹോളിമിയം Holmium	68 Er എർബിയം Erbium	69 Tm ത്ഥൂലിയം Thulium	70 Yb യുബേർബിയം Ytterbium	71 Lu ലൂത്സിയം Lutetium	72 Hf ഹാഫ്നിയം Hafnium	73 Ta ടാണ്ടാലം Tantalum	74 W ടങ്സ്റ്റൻ Tungsten (Wolfram)	75 Re റേനിയം Rhenium	76 Os ഓസ്മിയം Osmium	77 Ir ഇർഡിയം Iridium	78 Pt പ്ലാറ്റിനം Platinum	79 Au സോൾഡോ Gold (Aurum)	80 Hg മെർക്കുറി (Hydrargyrum)	81 Tl ത്വാലിയം Thallium	82 Pb ലോഡ് Lead (Plumbum)	83 Bi ബിസ്മത്ത് Bismuth	84 Po പോളോണിയം Polonium	85 At അസ്റ്റാറ്റിൻ Astatine	86 Rn റേഡോൺ Radon	87 Fr ഫ്രാൻസിയം Francium	88 Ra റേഡിയം Radium	89 Ac ആക്റ്റീനിയം Actinium	90 Th തോറിയം Thorium	91 Pa പ്രോട്ടാക്റ്റിനിയം Protactinium	92 U യുറേനിയം Uranium	93 Np നെപ്റ്റ്യൂനിയം Neptunium	94 Pu പ്ലൂട്ടോനിയം Plutonium	95 Am അമേരിക്കിയം Americium	96 Cm ക്യൂർനിയം Curium	97 Bk ബെർക്കലിയം Berkelium	98 Cf കാലിഫോർനിയം Californium	99 Es ഐസ്റ്റീനിയം Einsteinium	100 Fm ഫെർമിയം Fermium	101 Md മെൻഡീലീവിയം Mendelevium	102 No നോബെല്ലിയം Nobelium	103 Lr ലോറന്ത്യം Lawrencium
---------------------------	---------------------------------------	--------------------------------	-------------------------------------	------------------------------	---------------------------------	-----------------------------------	-----------------------------	-------------------------------------	------------------------------	---------------------------	------------------------------	---------------------------------	-------------------------------	------------------------------	-------------------------------	---	----------------------------	----------------------------	----------------------------	---------------------------------	--------------------------------	-------------------------------------	-------------------------------	---------------------------------	-------------------------------	-------------------------------	-----------------------------------	-------------------------	--------------------------------	---------------------------	----------------------------------	----------------------------	---	-----------------------------	--------------------------------------	------------------------------------	-----------------------------------	------------------------------	----------------------------------	-------------------------------------	-------------------------------------	------------------------------	--------------------------------------	----------------------------------	-----------------------------------