

INFORMATION & COMMUNICATION TECHNOLOGY

Standard VIII



GOVERNMENT OF KERALA
Department of General Education

State Council of Educational Research and Training (SCERT), Kerala

2016

THE NATIONAL ANTHEM

Jana-gana-mana adhinayaka jaya he
Bharatha-bhagya-vidhata,
Punjab-Sindh-Gujarat-Maratha
Dravida-Utkala-Banga
Vindhya-Himachala-Yamuna-Ganga
Uchchala-Jaladhi-taranga
Tava subha name jage,
Tava subha asisa mage,
Gahe tava jaya gatha.
Jana-gana-mangala-dayaka jaya he
Bharatha-bhagya-vidhata,
Jaya he, jaya he, jaya he,
Jaya jaya jaya jaya he!

PLEDGE

India is my country. All Indians are my brothers and sisters.

I love my country, and I am proud of its rich and varied heritage. I shall always strive to be worthy of it.

I shall give my parents, teachers and all elders respect, and treat everyone with courtesy.

To my country and my people, I pledge my devotion. In their well-being and prosperity alone lies my happiness.

Information & Communication Technology-VIII

Prepared by :

IT@School Project

Poojappura, Thiruvananthapuram-12, Kerala
for **State Council of Educational Research and Training (SCERT)**
Poojappura, Thiruvananthapuram - 12, Kerala

Website : www.itschool.gov.in, www.scertkerala.gov.in
email : contact@itschool.gov.in, scertkerala@gmail.com
Phone : 0471-2529800, 0471-2341883, Fax: 0471-2529810, 0471-2341869
Type setting : IT@School Project
Layout : IT@School Project
Printed at : KBPS, Kakkanad, Kochi-30
First Edition : 2016

© Department of General Education, Government of Kerala

FOREWORD

Dear Learners,

The world around us is changing fast. The borderlines that were created by time and distance are fading away. The infinite potentials of Information and Communication Technology made so many things possible which were considered impossible. This is the era in which our classrooms are rapidly transforming into smart rooms with multimedia facilities, as a result of new technology. In tune with these changes, the contents in this textbook are developed to enable you to move towards the world of technology, to promote self-study and to construct new knowledge.

Each and every activity included in this textbook is prepared by assimilating the contexts in similar lessons from other subjects. It will be helpful for the study of those lessons.

The lessons are designed in such a way that practical work is given prime emphasis. I sincerely believe that you will be able to do and practise all learning activities given in this textbook, and make use of those acquired skills in the study of other subjects as well.

Dr. P. A. Fathima
Director
SCERT

TEXTBOOK DEVELOPMENT TEAM

Information & Communication Technology-VIII

Chairman

K. P. Noufal
Executive Director
IT@School Project

Experts

G. Vijayaraghavan
Member, Kerala State Planning Board
(Former CEO, Technopark, Trivandrum)

V. K. Adarsh
Manager (Technical)
Union Bank of India, Calicut

Members

M.Ganeshkumar
Academic Officer,
IT@School Project

Joesph Antony
District Co-ordinator
IT@School Project, Ernakulam

Jayaraj M.
District Co-ordinator
IT@School Project, Kannur

Rajesh. M.P.
District Co-ordinator
IT@School Project, Kasaragode

Muhammed Aslam. A.R.
AEO, Mankompu

S. Sambasivan
Headmaster,
Govt. Higher Secondary School
Neyyar Dam

Abdul Hakkim. C.P.
Master Trainer,
IT@School Project, Kozhikkode

Pradeepkumar Mattara
Master Trainer, IT@ School
Project
Malappuram

Shanavas K.
HSST
GJHSS Naduvattam

Muhammed Abdul Nasar
Master Trainer,
IT@School Project, Kozhikkode

V. K. Nisar
Master Trainer,
IT@School Project, Ernakulam

Vasudevan K. P
Master Trainer,
IT@School Project, Thrissur

Pramod. K.V.
Master Trainer,
IT@ School Project, Kozhikkode

Suresh E.
Master Trainer (Cartoonist)
IT@ School Project

Academic Co-ordinator

Jose D. Sujeev
Research Officer (English & IT)
SCERT

Expert

Dr. Deepa L.C.
Asst. Professor, English
Govt. Womens College
Thiruvananthapuram

Co-ordinator

Hassainar Mankada
Master Trainer
IT@School Project

English Translation

Satheesan V. P.
HSA English, GVHSS Meppayur

V. K. Babu
District Co-ordinator
IT@School Project, Kozhikkode

Priya. V. M.
Master Trainer, IT@School Project,
Kozhikkode

Suresh. S.R.
Master Trainer, IT@School Project,
Kozhikkode

CONTENTS

1	When A Letter Reaches the Computer.....	07
2	The Wonderland of Pictures.....	25
3	Can you Type aaaa in the Computer..	37
4	The Amazing World @ your Fingertips	47
5	My Own Computer Game.....	60
6	Data Analysis Made Easy	74
7	Laboratories in your Computer.....	90
8	Attractive Presentation	107
9	Hello...Mic Testing	118
10	My Computer.....	131

**Certain icons are used in this
textbook for convenience**



For further reading
(Evaluation not required)



Let's Evaluate



Follow up activities



1

When A Letter Reaches the Computer

By learning this unit, the learner will be able to:

- ◆ identify and use different text input-output devices.
- ◆ acquire speed and accuracy in typing using keyboard.
- ◆ use efficiently the text editing tools like cut, copy, paste, etc.
- ◆ organise the text into different paragraphs.
- ◆ insert pictures in text at relevant positions.

The Recuyell of the Historyes of Troye

William Caxton was the first Englishman who learned to use a printing press. The Recuyell of the Historyes of Troye was the first book he printed and the first book printed in English. It was produced in 1473 either in Bruges or Ghent in the European continent. The book by Raoul Lefevre is a recuyell (compilation) of stories about the Trojan War, originally written in French. Caxton himself translated the book.

British Library - Learning English Timeline

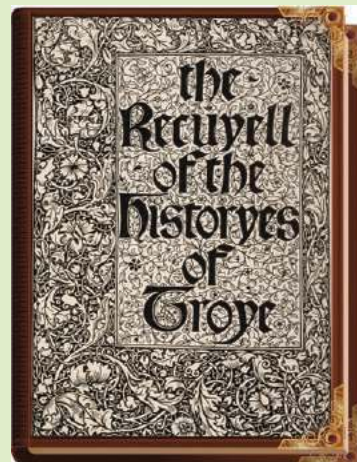

When A Letter Reaches the Computer

As years passed, stone moulds which were used for printing gave way to metal moulds. Later these moulds also went out of use. Nowadays, the contents of a book are typed and arranged (layout) with the help of computers.

Have a look at the extract from a page of your English Reader given below (Pic. 1.1). How would this have been prepared? Definitely, with the help of a computer. This is exactly what we are going to learn in this chapter - how to prepare a page like this with the help of a computer.



Typewriter



Have you ever seen a machine like this? This is a typewriter which was used in earlier days for typing. As computer became popular these machines are no longer in use.

Text entry

Taj Mahal

Taj Mahal is considered as one of the seven wonders of the world. It is a work of art that excels time and history. The following lines are from Tagore's poem 'Shah Jahan'. In this poem Tagore speaks of the immortal creation, the Taj Mahal and the timeless appeal of that great monument.

You knew, Emperor of India, Shah Jahan,
That life, youth, wealth, renown
All float a way down the stream of time.
Your only dream
Was to preserve forever your heart's pain.
The harsh thunder of imperial power
Would fade into sleep
Like a sunset's crimson splendour,
But it was your hope
That at least a single, eternally-heaved sigh
would stay
To grieve the sky.

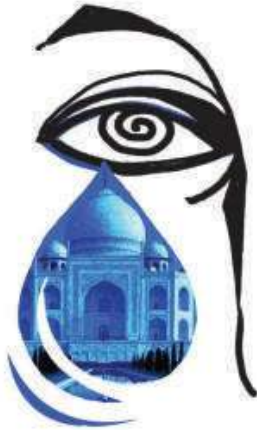



Though emeralds, rubies, pearls are all
But as the glitter of a rainbow tricking out empty air
And must pass away, Yet still one solitary tear
Would hang on the cheek of time
In the form
Of this white and gleaming Taj Mahal

Pic. 1.1 Tagore's poem - Taj Mahal

This page contains text and images. How can we input the text into the computer? Which hardware can we make use of for this purpose?

It is the keyboard which is familiar to us that comes to our help. The manner in which the letters of the alphabet are arranged in a keyboard is called 'Keyboard Layout'. Look at Pic.1.2 and examine the layout of an English keyboard.

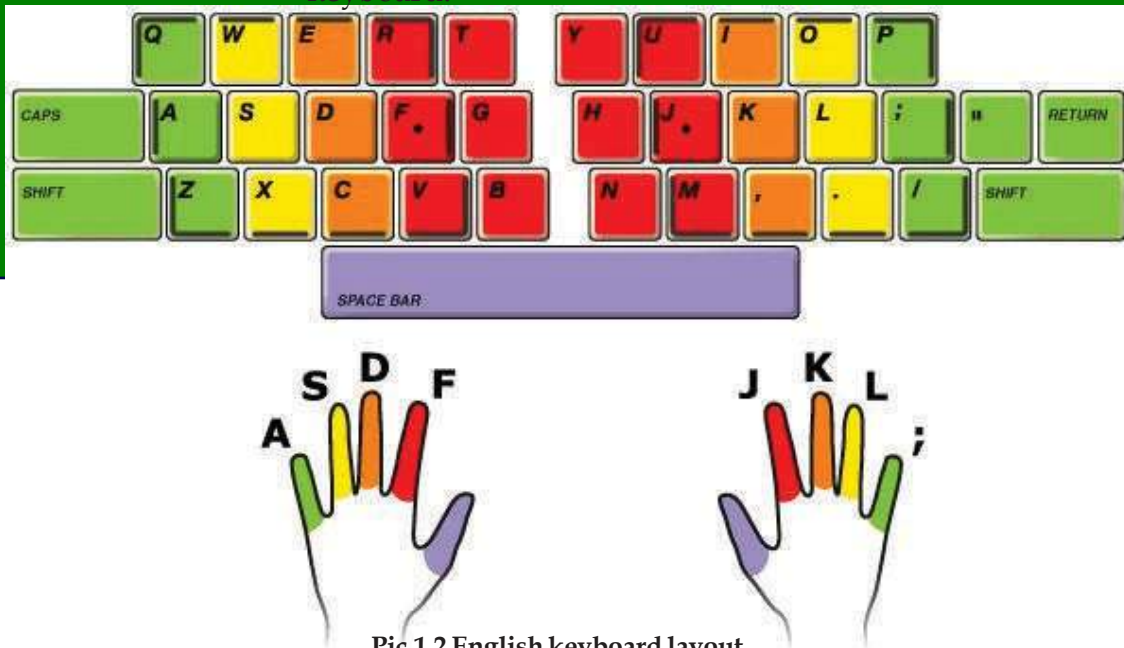

Pic.1.2 English keyboard layout

Have you noticed a mark on the keys 'F' and 'J' on the keyboard (see Pic. 1.2)? We must position our pointer finger of both the hands on these keys and then the other fingers on the subsequent keys accordingly. Now, move your fingers to the top and bottom rows to find out which keys can be typed using each finger. You might have to stretch your fingers to type some keys in the other rows.

You can see that you will have to use your pointer finger and little finger of both hands to type more keys arranged in all rows of the keyboard. Refer Pic 1.2 and identify the keys to be typed using each finger.

Practice typing

To type quickly and accurately is a skill one has to acquire through practice. There are various software that help us to learn typing in a scientific way. KTouch, Tux Typing, etc. are examples of typing tutor software. Test your typing speed using the

When A Letter Reaches the Computer

KTtouch typing tutor installed in a computer. One must be able to type at least 40 words (200 characters) per minute without mistakes.



Pic.1.3 KTtouch screen



Little finger not too little!

How many letters are there which are to be typed using the right hand little finger? List them down. You can see that your little finger is not that little!



Information in the form of letters

We have learned to type letters, numbers and symbols using a keyboard. What are the occasions where we need to type letters, words and sentences?

- ◆ To draft letters
- ◆ To prepare articles
- ◆ To prepare documents
- ◆

.....

Here we want to type a poem in a computer. What must we do?

- ◆ Type the words in the poem. If there are mistakes occurred when we typed it, we have to correct them.
- ◆ If some words are found inappropriate, we will have to replace them with some other words.
- ◆ If you have to replace a particular word or a name with another in an article containing 500 pages, what will you do?
- ◆ You may sometimes find sentences misplaced. How will you place them correctly?

Text

The information given as input to a computer in the form of characters, is technically known as text. The characters like letters, numbers and symbols that we have already typed can also be called text. The major device used to input text is a keyboard.

- ◆ Headings and letters can be made attractive by giving colours.

- ◆

- ◆

- ◆

Likewise there are a number of things that we have to do while using a computer. There are various options in our computer that help us to do these activities.

Word processor

There are numerous software which help us to prepare or process the text that we input into a computer in the way we wish to. See Table 1.1.

Software	Software developed by
LibreOffice Writer	The Document Foundation
Microsoft Word	Microsoft Corporation
Appache OpenOffice Writer	Appache Software Foundation
Abi Word	Abi Source Project

Table. 1.1 Software and their developers

The software listed in the above table are generally called *word processors*. Identify which of these software are there in your computer.

How can you open the software LibreOffice Writer installed in your computer?

.....

Activity 1.1 - Let's type a poem

Using the keyboard of your computer type the lines given below in LibreOffice Writer.

When A Letter Reaches the Computer

Taj Mahal

Taj Mahal is considered as one of the seven wonders of the world. It is a work of art that excels time and history. The following lines are from Tagore’s poem ‘Shah Jahan’. In this poem Tagore speaks of the immortal creation, the Taj Mahal and the timeless appeal of that great monument.

You knew, Emperor of India, Shah Jahan,
That life, youth, wealth, renown
All float away down the stream of time.
Your only dream
Was to preserve forever your heart’s pain.
The harsh thunder of imperial power
Would fade into sleep
Like a sunset’s crimson splendour,
But it was your hope
That at least a single, eternally-heaved sigh would stay
To grieve the sky.

.....
.....
.....
.....

While typing these lines, we leave a space after each word and when we complete a sentence, don’t forget to give a full stop mark and a space.

We know that when the text reaches the end of a line, it automatically goes to the next line. To start a new paragraph, press the Enter key. If we want to go to next line - not as a new paragraph - without completing the previous line (it often happens when we type poems), hold the Shift key and press the Enter key.

Other input methods

There are many people around us who are not able to type using a keyboard. Similarly, there are some who cannot read the text displayed on the computer screen. Won’t they have the need to use computers? How is it possible for them to to use a computer? There are various ways to help such people to input text and read the matter displayed on the screen.

Text from books

The matter from a book can either be identified and read or converted to a text file in a computer using various software. Normally it is done in the following way :

- Take an image of the page using scanner and save it in the computer.
- The next step is to identify the characters in the image and change them to a text format, like the one we get while typing using a keyboard. There are software which can do this work very well. They are called OCR (Optical Character Recognition) software. LIOS available in our system is one such software. It works based on the OCR software like CUNEIFORM and TESSERACT.
- Software that converts handwritten words on the screen of our mobile phone, into text is very common these days. This is also an example of a software which identifies letter forms and converts them to text.
- Such a file which contains the data so converted can be used as an ordinary text file.

Text from speech

Identifying the words of our speech, converting them to text and feeding them into a computer (Speech to text) is another method.

Such text input is done as follows :

Input our voice into the computer using a microphone.

Convert the audio data that has been input in the computer into a text with the help of software. Sphynx, Julius, Simon, etc. are such speech recognition software for English. Find out if there are any such software for Malayalam.

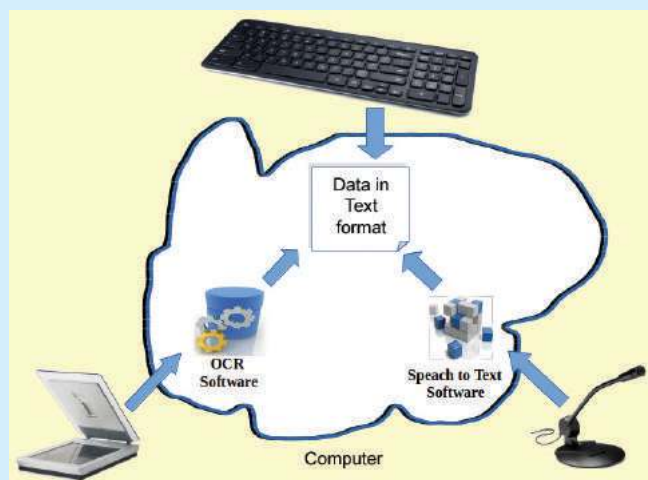

Pic.1.4 Different input methods

Text editing

It is natural that we make mistakes while typing. How do we correct them? Should we do the correction while typing itself?

◆ Notice the vertical blinking black line in the software window that moves as we type. This is called the cursor. Cursor denotes the position of the text that we are typing. We can place the cursor anywhere in the text by clicking the mouse on that place (we can also use the arrow keys on the keyboard).

- ◆ It is better to make the correction only typing the whole matter. This saves more time.
- ◆ If we find mistakes after typing the matter, what will we do? Place the cursor on the incorrect word. Use the Backspace key to delete the letter on the left of the cursor (before the cursor). To delete the letter on the right of the cursor (after the cursor) use the Delete key. Then, type the correct letter.
- ◆ A dictionary is included in the word processor software. Each word we type in, is verified in this dictionary. When a word which has not been included in the dictionary is typed, it is marked by underlining the word. Right click the mouse on the underlined word. What do you see in the menu?
- ◆ Imagine that we have misspelt a word and we are not sure the correct spelling. What will we do now?
 - Right click the mouse on the word.
 -
- ◆ How can you include a new word in the dictionary?
 -
- ◆ If the word is not in the dictionary and we don't want to add it, what will you do?
 -



While dealing with more than one window

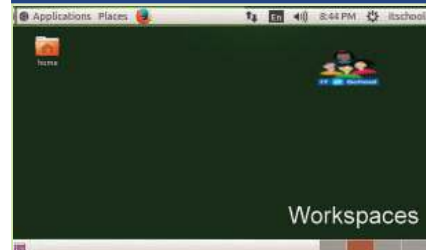

Pic.1.5 Desktop and Workspace

Pic. 1.5 shows the 'Desktop' of a computer (Operating system). The rectangular regions seen on the right hand bottom indicate different workspaces.

Let's open one window in the first workspace. Examine whether it is visible when we switch over to the second workspace. This is an efficient system when we have to deal simultaneously with more than one window. We can open different software in each workspace, if needed. We can also transfer or share data between windows that are opened.



QWERTY Keyboard

Examine a keyboard in detail. We can see that the letters are arranged in 3 rows. The first few letters towards the left in the first row is QWERTY. Therefore, this keyboard layout is called 'QWERTY Layout'.

Let's copy from one file to another

At present we are on the first workspace. Now, click on the second workspace and open the Home folder. Here you can see School Resources folder in which you can see a file 'Taj' in the Std VIII folder. You have observed the poem that is typed in, haven't you? You may copy the required lines and paste it in your page. How can we do it?

- ◆ Select the required lines: Place the cursor before the first letter of the text to be copied. Then, click and hold the left button of the mouse and move the pointer to the last letter. This process is called 'click and drag'.
- ◆ Copy the selected part : Click the shortcut tool  you see in the tool bar or click on 'Copy' seen in the 'Edit' menu.
- ◆ Now, let's go back to the window that was left open in the first workspace. Here, we can see the file that was opened earlier. Now, paste the copied text in the required position.

Did you notice 'Paste' in the 'Edit' menu when you opened it for copying? Now, how can you paste the copied text?

.....
.....

One can also see 'Cut' in the 'Edit' menu. What happens if you 'Cut' and 'Paste' instead of 'Copy' and 'Paste'? What difference do you notice?

.....
.....

Activity 1.2 - Let's copy a file

From the given file 'Taj', copy the second paragraph and paste it into your file. Write down in your notebook the process you followed.



Death by comma

Make sure to type the symbols in appropriate position. See what happens otherwise.

Let's eat grandma!



Let's eat, grandma!

**PUNCTUATION
SAVES LIVES!**

Let's save

Now, we have completed typing the poem. Let's store this before we proceed. We generally come across instances where we have to reuse the work done previously by us in a computer. For this, we have to store such files. This process is called 'saving'. How do we save this page?

Folders and sub folders

Each and every work we do in a computer is saved as a file. Thus we will have a number of files on the various works we have done. It is important to arrange and save these files properly for future use. It can be done with the help of 'Folders'. We can create folder as follows:

- ◆ Place the mouse pointer on an empty space where you want to create a folder.
- ◆ Right click the mouse.
- ◆ From the menu select 'New Folder'. We will get a new folder on the place where we clicked.
- ◆ Give appropriate name for this folder.
- ◆ Press 'Enter Key'. Now, the folder is ready.

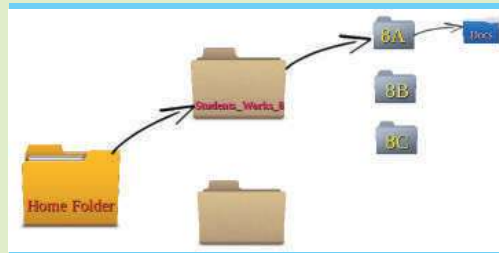

In the same way one can also make sub folders (folders within a folder). This helps us to categorise and save different files on the same topic. Refer Pic.1.6. Create a folder, Students_Works_8 in the 'Home' folder. Inside this folder, create a folder by the name of your class and a folder named 'Docs'.

Now, let's try to save the file that we were working with. We can do this by clicking on the tool  in the LibreOffice Writer window. We can see our folders listed on the right side in the window that pops up (Refer Pic.1.6).

Then, place the mouse pointer on the required folder and 'double click' on it. Likewise, by double clicking on the folder, you can open your class folder and other sub folders.



To save a file:

First, decide where to save the file. Here, we have to save the file in the sub folder 'Docs' in the class folder in Students_Works_8 which is present in the Home folder.

If we want to save on the Desktop, refer to Pic.1.6 and identify the icon to be clicked. (Desktop is where we open all the software windows. It is not a good practice to save files on the 'Desktop'.)

What should be the name of the file to be saved? We save files to use them at a later time. So, when we name a file, it would be better to name it based on the content. It would be better to name the file using a single word. Shall we name this file 'Taj_Mahal'?

Now, click on the 'Save' button.

This is the home folder. It is the place to store the files of the user.

To save in the Desktop open this.

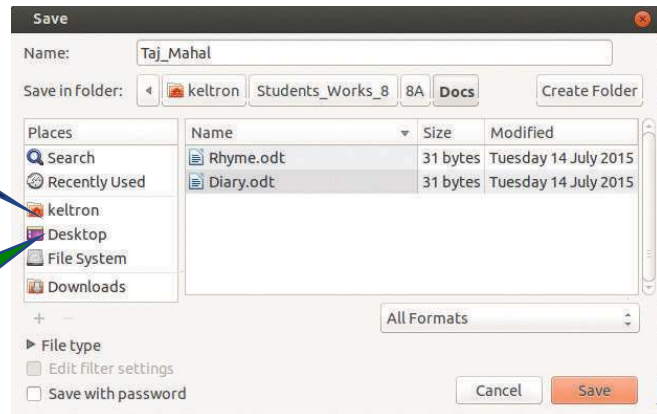

Pic. 1.6 Window for saving a file

Let's beautify the characters

We have added all the lines in our page. Does the computer understand that this is the heading?

For this, select the sentence. From the 'Apply Style' tool in the tool box, choose 'Heading1'. Observe what changes happen to the heading.

When A Letter Reaches the Computer

See how we can make the heading attractive?

Colour : Blue
 Size : 30
 Style : Bold
 Font : Free Sans

See some of the tools that we can make use of in LibreOffice Writer.

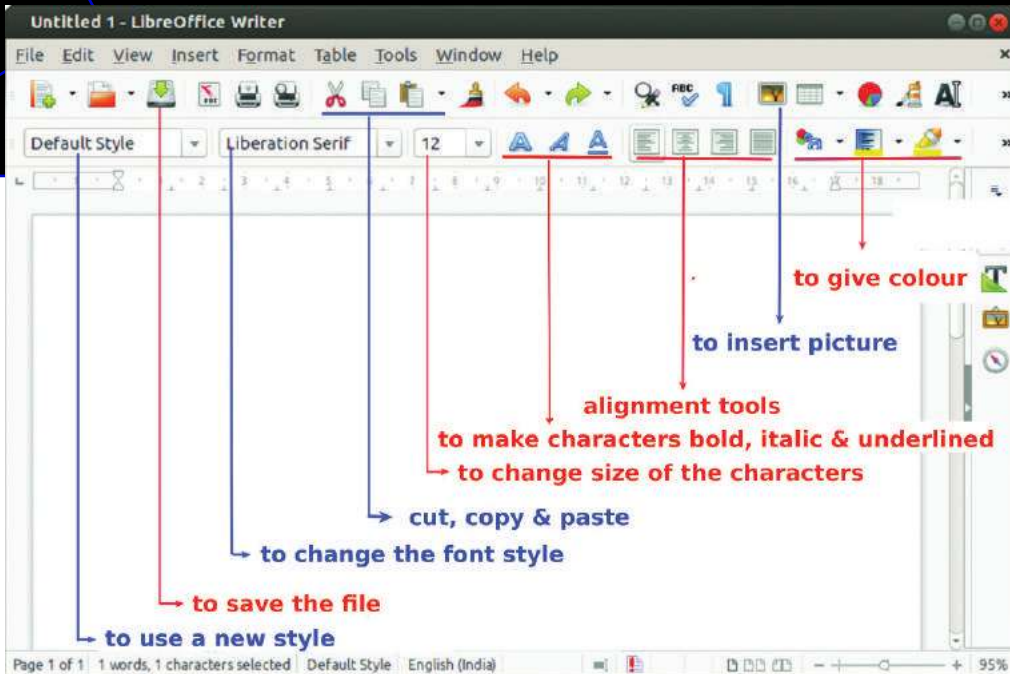

Pic.1.7 LibreOffice Writer window

Which tools are to be selected for the above activities? Fill in the table below.

Character	What/How much?	How to do?
Colour	Blue	
Size		
Style		
Font		

Table 1.2 Character formatting

Paragraph formatting

We have already discussed how to split the input text into different paragraphs. 'Paragraph Formatting' helps us to:

A few English fonts

- Elegante*
- Liberation Serif
- BABEL Unicode
- Delphine*
- Bitstream Charter
- URW Gothic L
- Century Schoolbook I
- Steve*
- DejaVu Sans
- DejaVu Serif
- Domestic Manners*
- Nimbus Roman No9 L
- URW Chancery L*

- ◆ adjust the spacing between lines.
- ◆ adjust the spacing before and after a paragraph.
- ◆ give borders
- ◆ give background colours, designs etc. and make our text attractive

Select the text in a paragraph. Then click on 'Paragraph' in the 'Format' menu.

The window that opens is given in the picture below. You can give the required measurement in the boxes you see here.

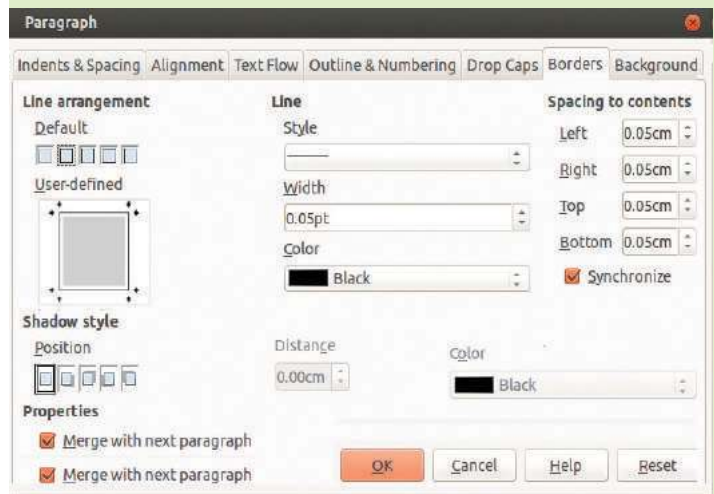
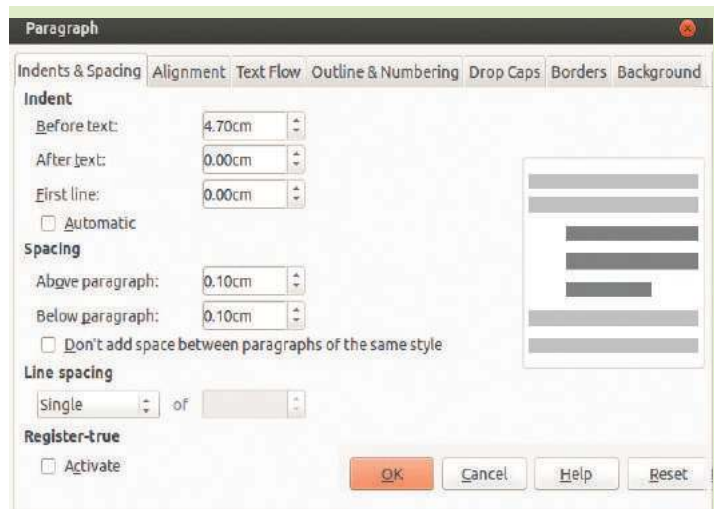

Pic.1.8 Paragraph formatting window

Refer to the picture and identify how to make the changes required and fill in the columns in the table overleaf.

When A Letter Reaches the Computer

Activity	Required change	How to make the change
Border of the first paragraph	Above & Below	Select the first paragraph. Select 'Borders' in Format - Paragraph window. Click on the  icon to give a border to the paragraph.
Colour of the border	Blue	
The spacing of the second paragraph from the left margin. This is called indent.		
Spacing above each paragraph		
Spacing below each paragraph		
Spacing between lines	Single	

Table 1.3 Paragraph formatting

Inserting pictures

Certain pictures are stored in the 'Images' folder in the 'School Resources' folder in the 'Home' of your computer. Identify the pictures we need to use in our page. These pictures can be included. Identify the tool used to insert images from Pic.1.7. Click on this tool and find out what happens.

In the 'Image' folder of 'School Resources', there is a picture named 'TajAndTears.jpg'. How can we include this picture in our page? Note down the steps.

- ◆
- ◆
- ◆
- ◆ Select 'TajAndTears.jpg' and click 'Open'.

Save again

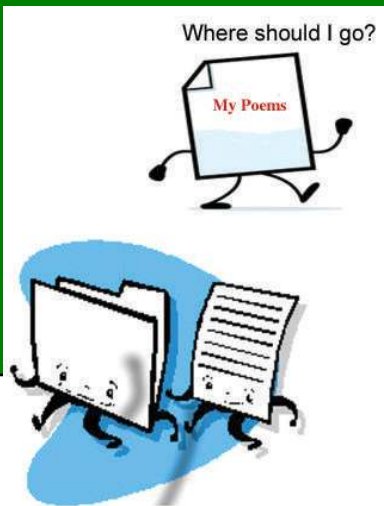

The file that we are working with was saved earlier. But we have made some changes in this file after saving it. Will these changes automatically be saved in the previous file?

No, we have to save it again. But what happens when we click ? Can we explain why the window that ask where to save the file and with what name, doesn't appear?

If you have to save the same file within a different name, what will you do?

- ◆

Activity 1.3

Arrange the text in your file into paragraphs as in Table 1.3. Include pictures and make the characters attractive. Do not forget to save your file.

Using only the keyboard...

Some tasks can be done with the keyboard alone. We had earlier done the Copy-Paste activity using the Edit menu. Let's examine this once again.

- ◆ Select the text to be copied.
- ◆ Press and hold the Ctrl key and then press C to copy the text.
- ◆ Press and hold the Ctrl key and then press V to paste it.

Certain shortcuts are listed below. Complete the table below.

Activity	Shortcut	Activity	Shortcut
To copy	Ctrl + C	To save	
To cut		To find a word in the text	
To paste the matter that has been cut or copied		To make the selected text bold.	

Table 1.4 Keyboard shortcuts

When A Letter Reaches the Computer

Out from the computer

The data taken out from a computer is called 'output'. What would be the output of the text that we have processed?

- ◆ While working with the text, we can see the display on the monitor. Therefore, the monitor is an output device.
- ◆ If we print this file, it is also an output. So, printer is a device to output our data.
- ◆ The file that we have saved itself is an output. It can be stored in devices like CD (Compact Disc), or pendrive, or it can be sent as an email to another person.

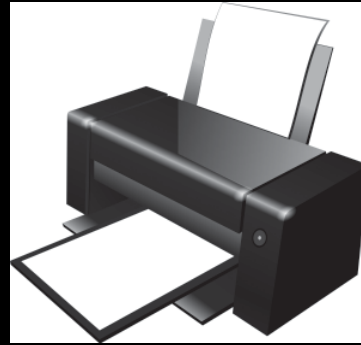

Pic. 1.9 Printer

Activity 1.4 - Machine reading

Open the file that we have saved earlier. Copy the text in it. Now, open the Gespeaker Software in your computer (Application → Sound and Video → Gespeaker). Paste the copied text in this window and play it (Refer to Pic.1.10)

What form of output is received from the text now?

.....
(Don't forget to connect the speakers.)



Pic. 1.10 Gespeaker window

Let's Evaluate

1. Some computer accessories are listed below. Which of them are used for text input?
 - a) Keyboard
 - b) Speaker
 - c) Scanner
 - d) Camera

2. Which of the following is true about the question:
What are workspaces used for?
 - a) To copy and paste a content from one file to another.
 - b) To cut and paste a text to another file.
 - c) To operate more than one window simultaneously.
 - d) To open various software at the same time.
3. When should we save a file we are working with?
 - a) After all the work with the file is over and when we are about to close it.
 - b) As soon as we open the software and start our work and then frequently save while working on it.



Follow-up activities

1. Look at the nursery rhyme given below:

There was a tree
The cutest little tree you ever did see
The tree was on the valley
And green grass grew
And green grass grew
And green grass grew around.
There was a branch
The branch was on the tree
The cutest little tree you ever did see
The tree was on the valley
And green grass grew
And green grass grew
And green grass grew around.

Can you guess what the next line of the song would be? Complete the poem by typing necessary lines and copy-paste the lines that are repeated. Replace the word 'green' with the word 'blue' in the text using 'Find and Replace'.

2. To copy a portion of a text from the word processor, we usually select the text by dragging the mouse from the beginning to the end of the text. There are some other ways also to select a text. Place the cursor on the text and do the activities given below and complete the table.

When A Letter Reaches the Computer

Activity	Result
One mouse click	No change in the position of the cursor.
Double click the mouse	
Click the mouse continuously for three times	

3. There are different ways to copy a portion of the text in a page and paste it elsewhere. You can use whichever method you are familiar with.

Now, select the text to be copied and click the right button of the mouse on it. What are the steps to be followed? Write them down.

.....

.....

.....



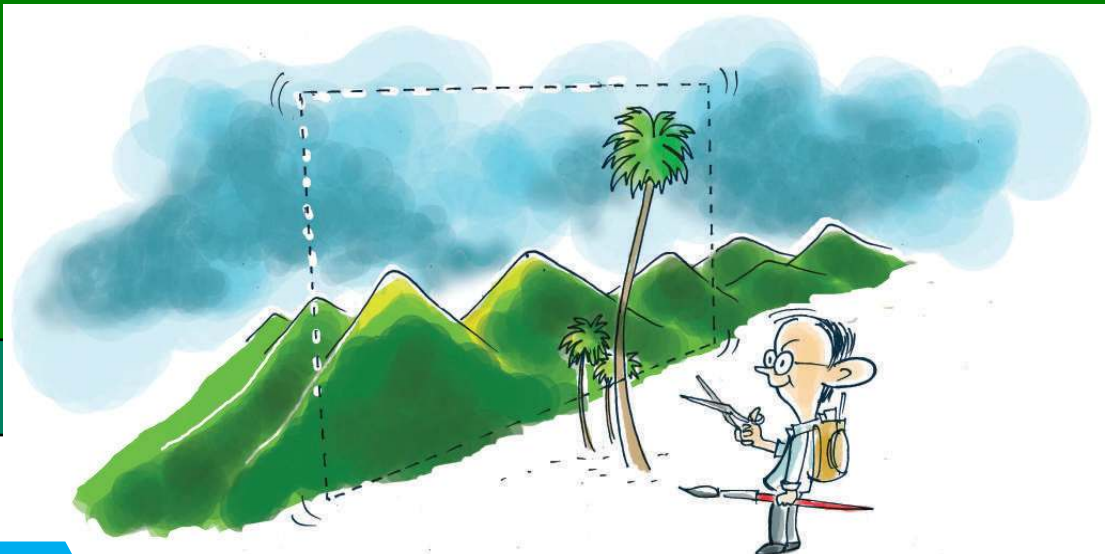

2

The Wonderland of Pictures

By learning this unit, the learner will be able to:

- ◆ prepare a write-up on the different ways of making digital pictures.
- ◆ use Image Viewer to open a picture, resize it and rotate it to the left and right.
- ◆ open pictures and photos using GIMP.
- ◆ take a duplicate copy of a picture in GIMP and edit it by cropping the unnecessary parts.
- ◆ resize the picture using GIMP.
- ◆ add new canvas in GIMP and give background colour. Type words and draw pictures in it.
- ◆ identify different file formats and classify them.
- ◆ export a picture prepared in GIMP into jpg, png and tiff formats.
- ◆ prepare logos using GIMP.
- ◆ prepare screenshots.



The Wonderland of Pictures

Hari happened to see an old family photo of his, while he was searching for a book last day. The photo attracted him very much. He desired to crop his childhood photo from it.

Haven't you faced such a problem in your life. Have you ever felt the need to crop a photo of yours and resize it with the help of a computer? This unit will help you to solve such issues.

There is a project 'Earth and Man' in the unit 'In Search of Earth Secrets' in your Social Science textbook. You have to collect pictures, crop the relevant parts and resize some of them and include them while preparing the project in the computer. How can you collect the required pictures? There are several methods by which you can do it.

Activity 2.1 - Let's get a picture

- ◆ Capture a photo using a digital camera and copy it in the computer.
- ◆ Scan a picture from a book or a newspaper and save it in your computer.
- ◆ Draw the picture in the computer.

Discuss and prepare a write-up on the various methods of preparing digital pictures.

Certain pictures that can be used in the project works are included in the 'Image_editing' folder of 'School Resources' for Std. VIII. Open the folder and double click on one of the pictures. Did the picture open? It will be opened in GNOME Image Viewer. The complete name is 'Eye of GNOME Image Viewer'.

There are other image viewers in our computer. gThumb, Shotwell Viewer etc. are some of them. What will you do to see the next picture in the folder? Do we need to close the window which is opened now? Click on the 'NEXT' button. What other facilities are available in this image viewer?

- ◆ Zoom and view the picture.
- ◆ Rotate the picture to the left and right.
- ◆

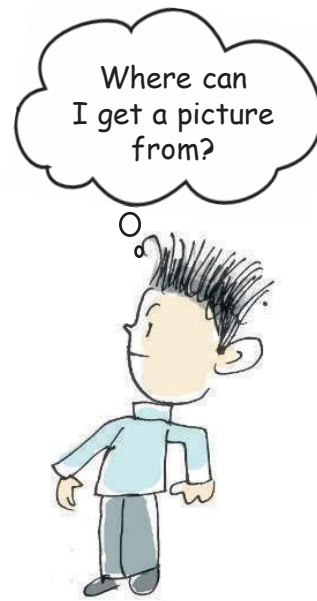



GIMP (GNU Image Manipulation Program)

GIMP is a graphic editor software used for editing digital pictures and photographs. This free software was released in 1996. In the beginning it was known as 'General Image Manipulation Program'. Spencer Kimball and Peter Mattis, two research scholars of California University, started GIMP as a research project. It became a part of GNU Project in 1997 and was renamed as 'GNU Image Manipulation Program'.

Look at the image opened in image viewer (Pic.2.1). Have you noticed the figures in the status bar below the picture. This is the size of the picture. The measurement is 1628 x 1083 pixels. We have to know the size of pictures while working with them on computers.

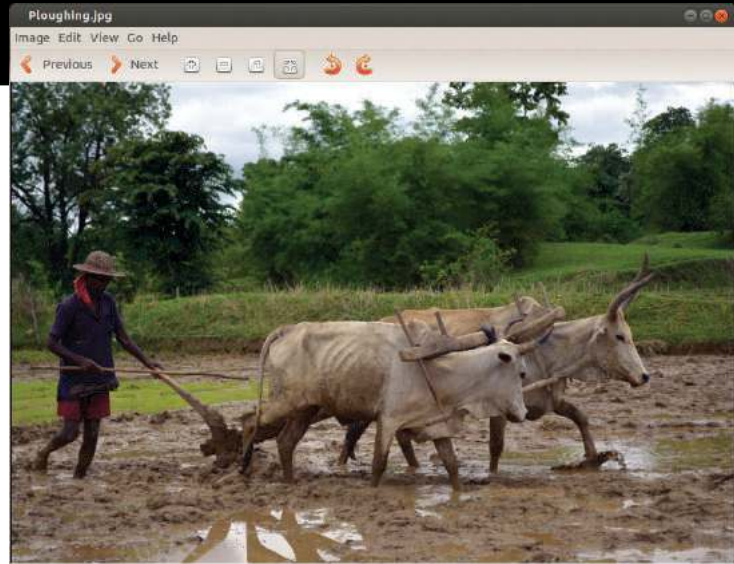

Pic. 2.1 - A picture opened in Image Viewer

Imagine that you have to cut the portion of the ploughed soil, bullocks and the plough man from the picture, to use it in the project work. We have to reduce the size of the picture too. How can we do these activities? There are a good number of software available in our computer to perform the above mentioned tasks.

- ◆ GIMP
- ◆ Inkscape
- ◆ Tux Paint
- ◆ XPaint
- ◆ MyPaint
- ◆ Pencil

The Wonderland of Pictures

These are some of such software. Open each of them and see how it works.

Let's perform the above said activities using GIMP. First, open an image in GIMP.

Activity 2.2 - Let's open a picture in GIMP

Click on 'Open' in the File menu and select pictures to open them in GIMP. Or right click on the picture. Then select 'Open With' and select 'GIMP Image Editor' to open the image.

Now, let's cut the parts of the picture we need to use in the project. If we edit and save the picture opened in GIMP, the original picture will be lost. To avoid this let's make a duplicate of the picture and do the editing on it.

Activity 2.3 - Let's prepare a duplicate image

Click on 'Duplicate' in the Image menu. Press and hold 'Ctrl' and then press 'D' on the keyboard. How can we identify the original picture from the duplicate one? 'Untitled' will be displayed in the title bar of the duplicate image. The changes made in the duplicate image will not affect the original image.

Activity 2.4 - Let's edit an image

Let's cut the part of the image we need. How can we cut an image using the Crop Tool  ?

- ◆ Select the Crop Tool.
- ◆ Drag the mouse and mark the part we need to cut.
- ◆ Press the ENTER key in the keyboard.

Did you get the part of the picture you need?

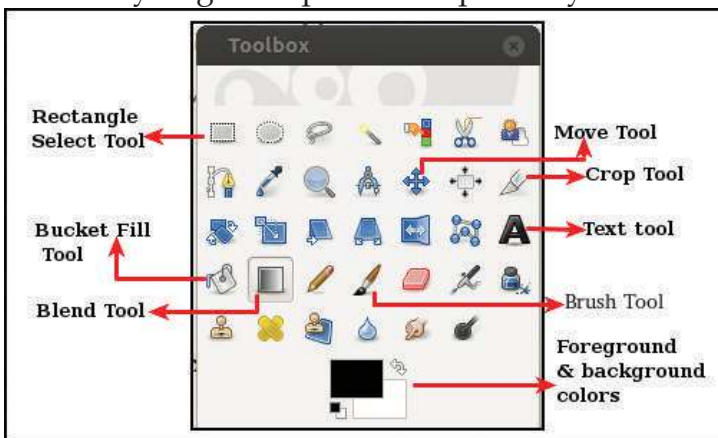

Pic. 2.2 - GIMP toolbox



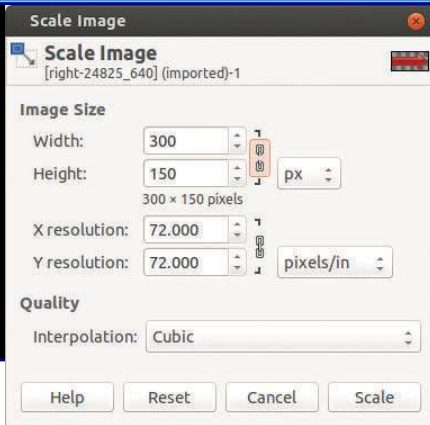

Pic. 2.3 - Scale Image window

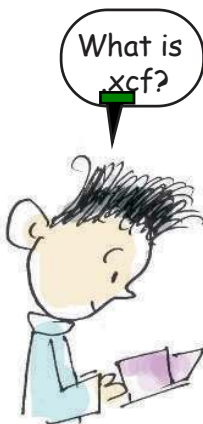
**Activity 2.5 - Let's resize an image**

Facilities for resizing an image are available in GIMP. To resize an image:

- ◆ Select Scale Image from Image menu.
- ◆ Enter the width and height in the columns provided.

The height will be automatically adjusted according to the width. (There is a Link which links the height and the width.) Then click on the Scale button. The size will be changed. How can we fix the width and the height as we like? Click on the 'Link'. It becomes 'Unlinked'. Now, you can arrange the width and the height as you like.

Now, let's save the image we have edited. Where can it be saved? You have already made a folder in your class folder in 'Home', haven't you? Open it and make another folder named 'Images' in it. Save this image in it. Don't forget to name the file.

Activity 2.6 - Let's identify file formats

Let's analyse the files saved in the folder. You can see the extension .xcf after the file names you have given. This is to indicate the type of the file. .xcf is the indication of a file created in GIMP.

Activity 2.7 - Let's export an image created in GIMP

Open an image created in GIMP. Does it open in Image Viewer like the other images? It's opened in GIMP itself. Why is it so? It's only a project file. It can be used only when it is converted into an image format. 'Export' is used to change a file from one format to another and save it. How can we export a file?

- ◆ Select 'Export' from the File menu.
- ◆ Choose the location to save the file.
- ◆ Name the file.
- ◆ Click on 'Select File Type' and choose the file

The Wonderland of Pictures

type, i.e., PNG image, JPEG image, TIFF image etc. Now, you can see file extension after the file name.

- ◆ Click on the 'Export' button.

Analyse different types of files in your computer and identify their file formats. There are different files in the folder 'Examples' in 'School Resources' folder for Std. VIII. Don't you see file formats in each of these files? Open each of them and identify the file types.

Identify the file formats given below and complete the table. (Table 2.1)

File formats: jpg, mp3, png, wav, mp4, ods, odt, mpg, avi

File	Format
Image	
Sound	
Video	
Spreadsheet	
Word processor	

Table 2.1 : File and format

You have already collected the pictures to be included in the project report. Now, let's prepare a cover page for your project report. (Pic.2.4)



Project file

It may not be possible for us to complete all the editing of a picture at a stretch using the GIMP software. We will have to open the file many times and make necessary changes. Hence we keep them as Project File. We will export them as picture, only when all the editing works on it are finished. When we edit videos using video editing software, we keep them as Project Files. We can continue editing only when the file is saved as Project File.



Wilber

Wilber is the official lucky symbol of GIMP. It was prepared by Tuomas Kuosmanen of Finland in 1997.

SOIL AND HUMAN INTERVENTION



Project Report

Athira. C

Pic. 2.4 - Cover page

Activity 2.8 - Let's prepare a cover page

Open GIMP first and make a new canvas. How can we make a new canvas in GIMP? Do the following activities.

- ◆ Click on the 'New' button in the 'File' menu.
- ◆ You will get a new window. Here you can select the template you like. You can also set the canvas by typing the required width and height. (We prepared the project report in A4 format. Therefore you can select A4 from the templates given to prepare the cover page).
- ◆ Click on the OK button.

The Wonderland of Pictures

Now, you have got a new canvas. It's time to give background colour to it. As shown in the picture (Pic.2.4) you can mix colours using Blend Tool  to make the background more attractive and colourful.

Give colour to background

◆ Click on 'Foreground & background colors' 

and select suitable colours from it.



- ◆ Select Blend Tool.
- ◆ Click on the canvas and drag.

You have got the background coloured. Now, click on different points in the canvas and drag. What changes can you see? You can see the background coloured in different ways.

If you want to give a single colour to the background, you can use 'Bucket Fill' tool .

Add a text

Text Tool  can be used to add text. Click on the 'Text tool' button. Select a suitable font, font size and font colour from the 'Tool Options' (Pic.2.5) menu.

Click on the canvas and type the text you need to add. 'Move Tool'  can be used to arrange the typed text in its original position. Click on the 'Move Tool' button and then on the typed text. Then, move the mouse pointer. Did you feel any difficulty to re-arrange the text? You can re-arrange the text when the mouse pointer touches the text. A mark  appears on it. If you click and drag the text, it can be moved. Type the text and arrange it in proper positions.

Draw a picture

Shall we draw a picture and add it in the cover page (Pic.2.4) 'Paintbrush Tool'  can be used for



Peter Mattis



Spencer Kimball

GIMP was created by Peter Mattis and Spencer Kimball, the American computer programmers, as a part of their research project, when they were students of the University of California.

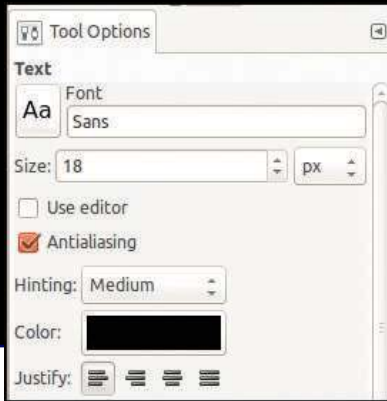

Pic. 2.5 Tool Options

this purpose. Select the suitable colour from 'Foreground & background colors' . Click on the 'Tool Options' button and adjust the size of the brush you need. Now, draw and add a picture and make the cover page more beautiful.

Try to draw a straight line using the 'Brush Tool'. Don't you feel a little difficulty to do this? Press the Shift key in the keyboard and try the 'Brush Tool' again. Is it easy now?

Activity 2.9 - Let's make the heading more attractive

Attractive titles can be prepared with the help of 'Logo' in GIMP. Let's see how a title can be prepared.

- ◆ Click on File → Create → Logos
- ◆ Select the Logos type you like.
- ◆ Type the title in the window and click on the OK button (Pic.2.6).



Pic. 2.6 - Logo window

You have prepared an attractive title. Export this title and convert it into a picture. You will learn how to use logo in GIMP, in the higher classes.

The Wonderland of Pictures

Activity 2.10 - Let's prepare a screenshot

Screenshot facility is used to save everything you see on the screen, as a picture. How can we do this?

- ◆ Display on the screen the portions we need to screenshot.
- ◆ Press the Print screen key (PrtSc) on the keyboard.

Didn't you get the screenshot? Now, save it. When you are making a screenshot, you get the picture of everything on the screen. If you want to get the screenshot of a window opened exclusively, press Alt key and PrtSc key together.

There are many other ways to prepare screenshots. We can make screenshots using GIMP software also. Using GIMP, it is easy to select a particular part of the screen and take the screenshot.

- ◆ Open GIMP and select screenshot from 'Create' in 'File' menu.
- ◆ Give necessary details in the window opened (Pic.2.7). (Whether to include the full screen or a particular portion, a window or a particular portion of a window, whether mouse pointer to be included, time of capturing etc).
- ◆ Click on 'Snap' button.
- ◆ If you have to capture a particular portion of the screen, click and drag to mark the part on the screen.
- ◆ Save the screenshot.

We can take screenshots using 'Screenshot' given in Accessories menu and 'Ksnapshot' given in Graphics menu. Take screen shots using these facilities and save them.

I've captured a scenery using my camera. How can I capture a picture from my computer screen?



Photo editing in mobile phones

Photo editing can be done in mobile phones also. Different facilities to resize a photo, crop it and add text to it are available in smart phones. Photo editing softwares for smart phones are easily available today.



Pic. 2.7 - Screenshot window



Let's Evaluate

1. Which shortcut method is suitable for making the duplicate of a picture opened in GIMP?
 - a) Ctrl + A
 - b) Ctrl + B
 - c) Ctrl + C
 - d) Ctrl + D
2. Eye of GNOME is an image viewer software. This statement is:
 - a) False
 - b) True
 - c) Partially true
3. Which tool is used in GIMP to cut a part of a picture?
 - a) Clone Tool
 - b) Move Tool
 - c) Crop Tool
 - d) Brush Tool

The Wonderland of Pictures

4. Match the following

File	File Format
Picture file	odp
Movie file	mp3
Spreadsheet file	jpg
Presentation file	mp4
Audio file	odt
Word Processor file	ods



Follow-up activities

1. Prepare a logo 'Keep Your Footwear Outside' in GIMP to paste it outside the school computer lab and export it.
2. Download a picture suitable for making a new year greeting card from the internet, with the help of your teacher. Open the picture in GIMP and crop the part you need. Resize and export it.
3. Open the 'Logo' window in GIMP. Take its screenshot using KSnapshot and save it.



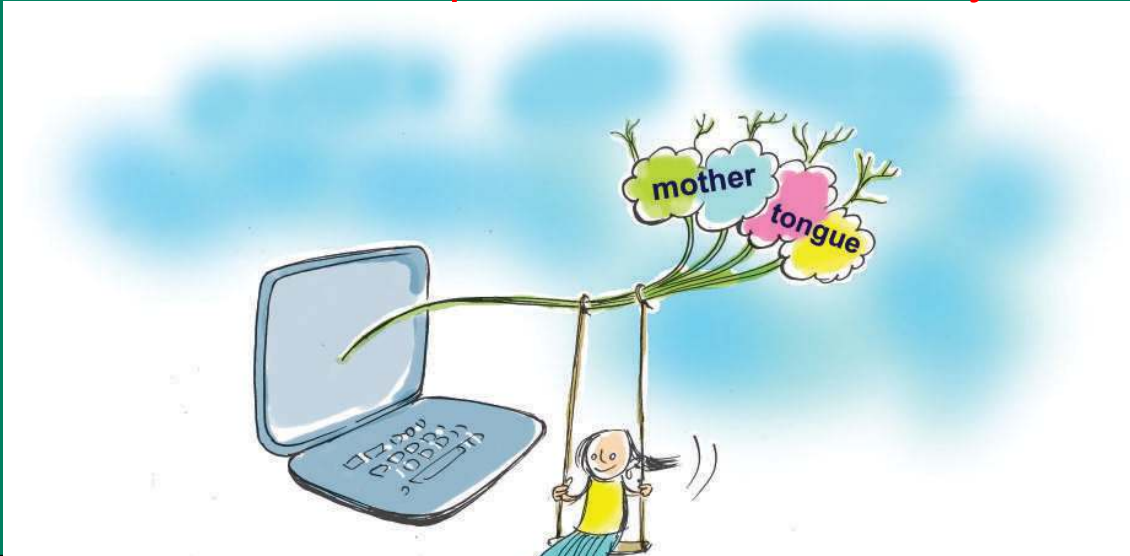

3 Can You Type 'അമ്മ' in the Computer?

By learning this unit, the learner will be able to:

- ◆ type Malayalam text with speed and accuracy.
- ◆ type Malayalam text as directed.
- ◆ type Hindi sentences.
- ◆ set the keyboard so as to input different languages.



അന്തിമലരി - അ
 ത്തിമന്തരം, സ
 സ്വയം വിട അന
 പൂവുള്ള ഒരു ചെ
 ടി, പന്തിരട്ടിപ്പു
 വ്. ഇതു വൈക
 ന്നേരം നാലുമണി
 ക്കു വിട അനതി
 താൽ “നാലുമണി
 പ്പുവ്” എന്നു പ
 റയുന്നു.



This is an extract from the Malayalam dictionary 'Shabdatharavaly' (ശബ്ദതാരാവലി) which was printed using metallic type foundry. In olden days, printing books in Malayalam was extremely difficult. There are over 500 different combinations of letters and symbols in Malayalam. Each of them needed separate moulds. Arranging these moulds to form the text was also not an easy task. Imagine the difficulty if a particular letter cluster appears many times in a page! For example 'ക്ക'. Think of the trouble of including the word 'ധൂഷ്ടദൃശ്നൻ' many times in a page! The task is not that easy...!

Can You Type 'അമ്മ' In the Computer?

*'മണിനാദം പോൽ മധുരം നമ്മുടെ
മലനാട്ടിൻ മൊഴി മലയാളം'*

These lines are composed by the famous poet Sri O N V Kurup about the beauty of our language. Can we type this in Malayalam and store it in our computer? Some of us write stories or poems in Malayalam. How is it possible to save them in computers?

Let's type in Malayalam

Normally, when we type using a keyboard, we find English letters on the computer. How can we change the keyboard layout to type Malayalam letters? Refer to Pic.3.1.

- ◆ Click on the icon **En** that is seen on the top right position on the Desktop.
- ◆ Choose Malayalam from the drop down menu.

Now, the keyboard is ready to input Malayalam letters.

Open the word processor and try to type the poem given above. Can you do it easily and accurately? In order to type fast, we should have a knowledge about the Malayalam keyboard layout.

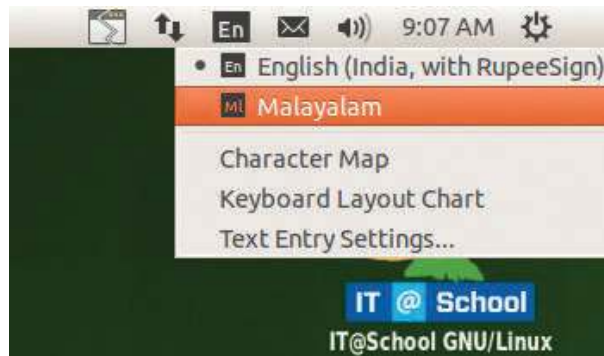

Pic. 3.1 Drop down menu of En icon

Inscript key layout

The order in which keys are arranged in a keyboard is called keyboard layout. This is based on the nature of the language and the flexibility of our fingers. Pic.3.2 shows the 'Inscript Key' layout developed by C-DAC, a central government agency for typing various Indian languages.

Refer to the picture and observe the layout. What are your findings?

The letters in Malayalam can broadly be classified into two - Vowels (സ്വരാക്ഷരങ്ങൾ) and Consonants (വ്യഞ്ജനാക്ഷരങ്ങൾ).

Can You Type 'അമ്മ' In the Computer?

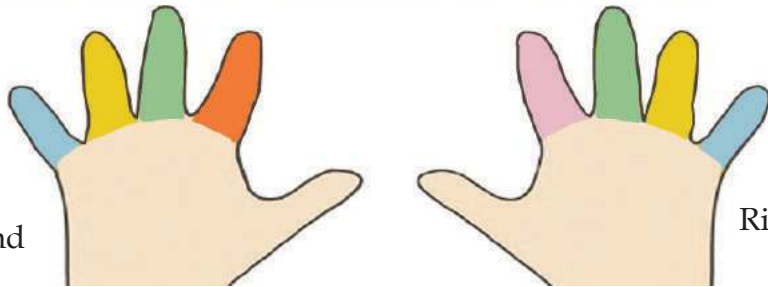

Left Hand

Right Hand

Pic. 3.2 Keyboard layout

The keys are arranged in such a manner that all the vowels (except 'ഗ്') are typed using the left hand.

Most of the consonants are typed using the right hand.

Now, position your fingers correctly, as explained in the first unit and complete the following table.

Finger	Normally		
	When Shift key is pressed		
Right hand, Middle finger	,	ക	ഗ
	ഷ	ഖ	ഘ
Right hand, Ring finger			
Right hand, Little finger			
Right hand, Little finger extended			
Right hand, Pointer finger			

Can You Type 'അമ്മ' In the Computer?

Right hand, Pointer finger extended	സ	ര	ഹ
	ശ	റ	ണ
Left hand, Middle finger			
Left hand, Pointer finger			
Left hand, Pointer finger extended			
Left hand, Ring finger			
Left hand, Little finger			
Left hand, Litter finger extended			
Thumb	Space bar		

Table 3.1 Fingering

Study the table given below and understand how combinations are made to form different letters.

ക ാ → കാ	ക ്ക → ക്ക
ത ൈ → ത്ത	ക ്ത → ക്ത
സ േ → സ്സ	ത ്യ → ത്യ
ന െ → ന്ന	മ ്പ → മ്പ

Table 3.2 Combination of letters and symbols

Activity 3.1 Lets type the words

Type the words give below. Make sure the keyboard layout is Malayalam.

- ◆ കര, തട, കട, പത, തകര, പരത
- ◆ കരി, ചിത്രം, പടരുക, ചേരുക, ചോരി
- ◆ സിന്ധു, മിഥു, കവല, കടുവ, നവനീതം
- ◆ അയല, ആമ, ഇല, ഇട, ഉടമ, ഉറമ, ഒരൂമ, ഓടുക
- ◆ ഒഴുത, കിരീടം, പുതുമ, പൂവ്, കൊടി, കോഴി, തൈമാവ്
- ◆ കാക്ക, സ്വന്തം, മുക്കുത്തി, ചന്ദ്രകാന്തം, സൗന്ദര്യം
- ◆ പരമ്പര, പങ്കായം, സഞ്ചാരി, പരിശ്രമം, ആഹ്ലാദം
- ◆ ദുഃഖം, ജ്യോ, തൃഷ്ണ, പാറ്റ, എന്റെ, തന്റേടം

Desktop Dictionary

Sometimes we find it difficult to understand the meaning of some words. Usually in such circumstances, we seek the help of a dictionary.

A dictionary named *Theeram* is installed in your computer which gives meanings and usages of words. It gives the English meaning of a Malayalam word or the Malayalam meaning of an English word.

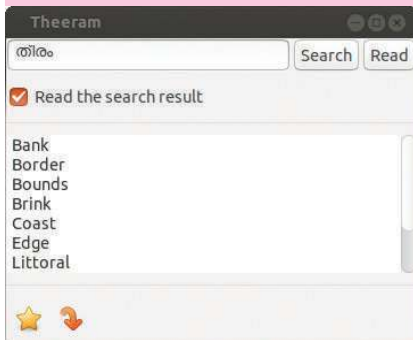

Pic. 3.2 Meaning of word തീരം

Don't forget to save the file. In which language are you going to name the file?

Let's now type some more words. For example അവൻ, മൺപാത്രം etc.

To type the Symbols (ചില്ലക്ഷരം) in such words we have to use a new key. This is the key used for this purpose.

For example,

- ൻ → ന ണ
- ർ → ര
- ൽ → ല
- ൺ → ണ
- ൾ → ഉ

Now, try to type the following words:

അവൻ, അവർ, അവൾ, മൺപാത്രം, വിൽപത്രം

Can You Type 'സഹ' In the Computer?

What happens when you type the word സഹ? How is it when you type സോഫ്റ്റ്‌വെയർ?

These are not Malayalam words. The letters should not be combined as the combination letters in Malayalam. To make these letters stand apart, we make use of another key .

Thus,

സഹ  ല → സഹ്ല

സോഫ്റ്റ്  വെയർ → സോഫ്റ്റ്വെയർ

The KTouch software that we used as English typing tutor can be used for learning Malayalam typing too. Open this software after changing the keyboard layout to Malayalam. We get the lessons to practise Malayalam typing. Seek the help of your teacher to learn how we can include new lessons for practice in this software.

Other Desktop Dictionaries

There are two other dictionaries namely 'Golden Dict' and 'Artha' which helps us to find the meanings & usages of English words.

'Golden Dict' is a multilingual dictionary. It gives us the English, Malayalam, Hindi and Urdu meaning of a word.

കുഞ്ഞനുരൂപം കുഴിയാനയും



ആരാണവിടെ പുഴിക്കുഴിയിൽ
ഞാനാണല്ലോ കുഴിയാന..
എന്താണവിടെ പുഴിക്കുഴിയിൽ
തടഞ്ഞുവീണേൻ ഞാനിപ്പോൾ..

Activity 3.2 Let's type a poem

Type this poem in word processor. Give the heading 'കുഞ്ഞനുരൂപം കുഴിയാനയും'. Also insert a picture. Select the lines of the poem and change the font to 'Raghu Malayalam'.

We have already learnt how to make changes in a text according to our requirement. Set the page as given here.



ASCII and Unicode

The letters and symbols that we input to a computer have to be converted to a format that can be understood by the computer. This process is called 'encoding'. Initially, this encoding could be done only for 256 characters including the letters and some symbols.

This encoding is called ASCII (American Standard Code for Information Interchange).

Under such circumstances it was not possible to use the letters of other languages like Malayalam. To overcome this difficulty, a solution was to convert English letters to Malayalam using a software. ISM developed by C-DAC is one such software. Though the font is visible as Malayalam letters, it is being encoded as English letters. This was a drawback of this software. It was difficult to search and find out a certain word from the input data.

As technology advanced, this problem was also solved. Unicode technique, which helps us to encode more characters, came into use from 1996. Thus Malayalam also found its place in the encoding technique. The letters and fonts of Malayalam could thus directly be input into the computer. This was a drastic change for Non-English languages.

Thus we can:

- ◆ Type Malayalam words in Malayalam font itself.
- ◆ Malayalam words can be used in the internet. Browse the web using Malayalam words.
- ◆ Include information in data banks like Aadhar, Voters list etc. in Malayalam. You can search and find names and other details from these data banks.
- ◆ If relevant software and font is available, the files created in one computer can be opened and read on other computers, tablet PCs or even on mobile phones.
- ◆ Texts can be read using machine. A text written in one language can be translated to another language using software.

Reading text using machine

If we input a text in a language other than English, we can hear it with the help of a software, provided the speaker is connected. How can we do this? Copy the poem typed earlier and paste it in Gespeaker software. Adjust the speed and pitch of the output and click the 'play' button. One can listen to how the software reads the text. Those who have visual problems and are not able to read from the monitor will surely find this software a blessing.

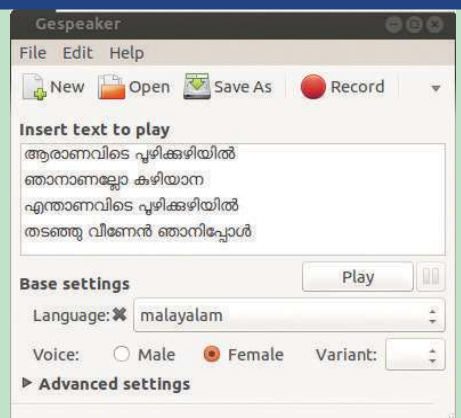

Pic. 3.4 Text in Gespeaker window

Can You Type 'അമ്മ' In the Computer?

Malayalam fonts

The style of writing of each person is different from that of another. The style of letters used in a computer is called font. For example, some common fonts of English alphabet are Liberation Serif, Liberation Sans etc. Similarly there are various fonts in Malayalam too. Find out the different Malayalam fonts in your computer and complete the table.

Malayalam fonts	
Rachana	Raghu Malayalam
Chilanka	Aruna
Meera	

Table 3.3 Different Malayalam font

Malayalam character styles

- മറ്റുള്ള ഭാഷകൾ കേവലം ധാത്രിമാർ
മർത്യനും പെറ്റമ്മ തൻഭാഷ താൻ - രചന
- മറ്റുള്ള ഭാഷകൾ കേവലം ധാത്രിമാർ
മർത്യനും പെറ്റമ്മ തൻഭാഷ താൻ - ചിലക
- മറ്റുള്ള ഭാഷകൾ കേവലം ധാത്രിമാർ
മർത്യനും പെറ്റമ്മ തൻഭാഷ താൻ - രഘു മലയാളം
- മറ്റുള്ള ഭാഷകൾ കേവലം ധാത്രിമാർ
മർത്യനും പെറ്റമ്മ തൻഭാഷ താൻ - അരുണ
- മറ്റുള്ള ഭാഷകൾ കേവലം ധാത്രിമാർ
മർത്യനും പെറ്റമ്മ തൻഭാഷ താൻ - സുഗമ

Change the font of the text that we have typed earlier. What differences do you notice when these changes are made?

Input of other languages

Activity 3.3 Let's add Hindi language

So far we have been discussing Malayalam typing. As Malayalam found its place in Unicode technique, other Indian languages also found their place in it. Now, let's examine how we can type in Hindi.

We must make some arrangements in our computer to type Hindi in it. Refer to Pic.3.5.

The input languages available in our computer is seen on the left side. What should we do to include Hindi? Complete Table 3.3.

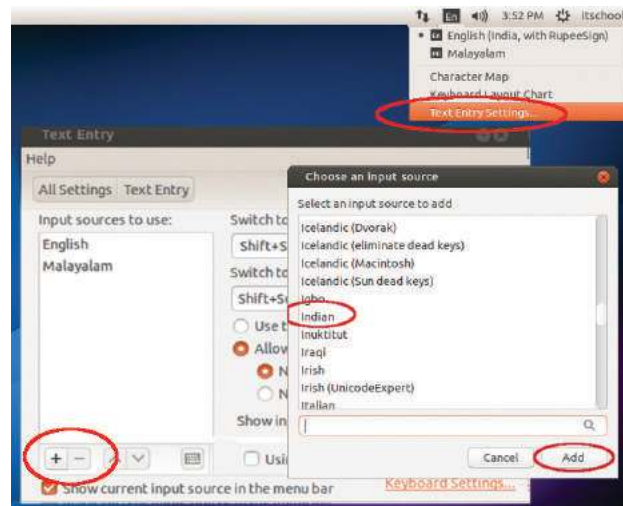

Pic. 3.5 Text entry setting window

Activity	Steps involved
Choose Text Entry settings	Click on Text Entry settings from the menu  on the right hand top of the Desktop.
Get the list of languages	
Add Hindi	Choose 'Indian' from the list.

Table 3.3 Steps to add Hindi language

Activity 3.4 Lets type Hindi letters

Change the keyboard layout to Hindi. Try to type your name on the word processor. Are the keys the same as the Malayalam letters. Prepare a similar table as Table 3.1 on the use of fingers in Hindi layout.

You need some extra symbols in Hindi than in Malayalam. Don't forget to include these in the table.

Activity 3.5 Lets type Hindi text

The text given below is a portion from your Hindi Reader. Type these lines using the font 'Gargi'.

खुशबू से और रंगों से
 एक फूल बोला - मैं इधर हूँ ।
 गानों से और लहरियों से
 चिड़िया बोली - मैं इधर हूँ ।

**Let's Evaluate**

- Which among the following keyboard layout helps us to type Indian languages including Malayalam?
 - Inscript
 - ISM
 - C-DAC
 - Rachana
- The following table was prepared by Arun. He wanted to categorise the fonts used to type Malayalam & Hindi. He made certain mistakes while preparing the table. Correct them.

Can You Type 'അമ്മ' In the Computer?

Malayalam	Hindi
Gargi	Anjali
Meera	Samanata
Kalimathi	Suruma

- We have learnt how to add a new language to our keyboard layout. Suppose we no longer need this language so added. How can we remove it? Take the system settings window and write down the steps to remove a language.



Follow-up activities

- A diary written by Appu has been saved in the sub folder 'Diary' in the folder 'School Resources' for 8th Standard in a jumbled order. Using the cut and paste tools, arrange the sentences in the correct order. Give the heading 'Appu's Diary'.

സ്കൂളിൽ ഇന്ന് ഉച്ചഭക്ഷണം വിതരണം ചെയ്യുന്ന ചുമതല ഞങ്ങളുടെ ബഞ്ചിനായിരുന്നു. രാത്രി 10.00 മണിയിായി. ഇപ്പോഴും മഴ പെയ്യുന്നുണ്ട്. ഉറങ്ങാൻ കിടക്കാം. ദിവ്യ ടീച്ചർ പറഞ്ഞ കഥ വളരെ നന്നായിരുന്നു. സൂത്രക്കാരൻ കുറുക്കനെ ഞങ്ങൾക്ക് ഇഷ്ടമായി. ഇന്നു രാവിലെ തന്നെ മഴയായിരുന്നു. ഞാൻ 6 മണിക്കു തന്നെ എഴുന്നേറ്റു. പോം വർക്കുകളെല്ലാം ചെയ്തു തീർത്തു. കണക്കുകളെല്ലാം വളരെ എളുപ്പമായിരുന്നു. 4.30 നാണ് സ്കൂളിൽ നിന്ന് തിരികെ വന്നത്. ആമിയും ഒപ്പമുണ്ടായിരുന്നു. 9.30 ന് സ്കൂളിൽ പോയി. വിന കാത്തു നിന്നിരുന്നു. പല്ലു തേപ്പും കുളിയുമെല്ലാം പെട്ടെന്നു കഴിഞ്ഞു. പിന്നെ ഞാൻ ഇന്ന് മലയാളം ടീച്ചർ ലീവായിരുന്നു. അതിനു പകരം ദിവ്യ ടീച്ചർ ക്ലാസിൽ വന്നു. അതുകഴിഞ്ഞ് ആമിയുടെ കണക്കുകൾ ചെയ്യാൻ ഞാൻ സഹായിച്ചു.

- Type the given poem and give a suitable heading.

കുനിടിച്ചു നിരത്തുന്ന യന്ത്രമേ
മണ്ണു മാന്തിയെടുക്കുന്ന കൈകളിൽ
പത്തുപോലൊന്നു കിട്ടിയാൽ നിർത്തണേ,
ഒന്ന് കൂക്കി വിളിച്ചറിയിക്കണേ,
പണ്ടു ഞങ്ങൾ കുഴിച്ചിട്ടതാണെടോ
പത്തു കായ്ക്കും മരമായ് വളർത്തുവാൻ.

Try to find out the name of the poet with the help of the internet. For this, copy the first line and paste it in the address bar of the search engine.



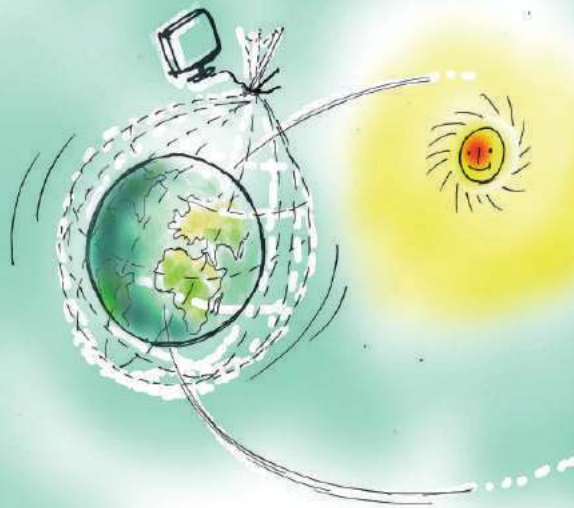

4

The Amazing World @ your Fingertips

By learning this unit, the learner will be able to:

- ◆ recognise and write that the internet is the network of networked computer.
- ◆ open and visit web pages using web address.
- ◆ make notes collecting required information from web pages.
- ◆ distinguish and write the differences between web browsers and search engines.
- ◆ collect images related to different subjects, meanings of words etc. from the internet.
- ◆ make notes by acquiring knowledge about E-commerce, Internet of Things (IoT) etc.
- ◆ make notes by acquiring knowledge about cyber crimes, misuse of mobile phones etc.

Let's know the mysteries of life in the little chamber

You have studied the lesson **Life's Mysteries in Little Chambers** in your Basic Science textbook, haven't you? Do you know that M.J. Schleiden, who discovered that the body of plants is made up of cells, was a lawyer? Robert Brown who discovered the centre of cell, was a doctor. There are cells which are known in the name of Theodor Schwann who discovered that the animal body is made up of cells. There are so many interesting facts like this in connection with the study of cells. Don't you feel it good to know more about such facts?

What will we usually do for this? We seek the help of our teachers. We read books from the library. Along with these, we can rely on computers and internet to collect information. Within seconds, the computer will help you to gather a lot of information on any subject with the help of internet. How does it work?

There are computer systems all over the world which contain information about almost all subjects. These computers work as inter-connected networks. Those computers which are connected to these networks can share the information stored in it. If we connect the computers in our school to this network, we can also access the information stored in them. But don't think that the information on the internet is fully dependable and correct.

Computer networks

- ◆ We have computer networks connecting computers at different locations around the world for various kinds of service and mega computer networks connecting different networks.
- ◆ This mega computer network spreading all over the world and the facilities given by it is generally called **Internet**.

Man gets a lot of services through the internet. Among them are:

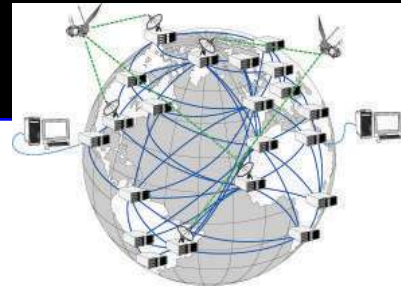

Pic.4.1 Internet diagram

History of Internet

The advanced research project agency under American Defence Department designed a computer network connecting computers at four centres named ARPANET (Advanced Research Projects Agency Network) for communication purpose on 2nd January 1969. This is the beginning of the internet. Later it is expanded as the internet that we see now by including many institutions and countries in this network. India also joined in the global network on August 15, 1995.

For more details: <https://en.wikipedia.org/wiki/Internet>



Internet cannot be switched off...!

The working of the internet which is world wide, cannot be stopped even for a day by anybody. This is because, the internet is not controlled from a single centre. Since the internet is a network of thousands of networks spread all over the world, even if one network fails all the others remain unaffected.

- ◆ Electronic learning which helps in education (E-learning).
- ◆ The World Wide Web which helps in the communication of information (WWW).
- ◆ The speedy mail service (E-mail).
- ◆ Video chat for face to face conversation.

- ◆ E-governance for getting governance and speedy access to service from government.
- ◆ E-commerce for buying goods from all over the world.
- ◆ Social networking sites help in the free cultivation of friendship and sharing of opinions between people all over the world.

Moreover, new facilities and techniques are developed on internet day by day.

Now, let's examine how information communication, one of the major facilities on internet, is helpful to us.

Activity 4.1 Searching for information...

You are instructed to find out additional information, images etc. about the cell from the internet in the first chapter **Life's Mysteries in Little Chambers** in your Basic Science textbook (Pic 4.2). How can we gather information from the internet? What are the prerequisites needed for this?

1. Our computer should be connected to the internet.
2. We should know where the information is stored in the internet.
3. We need a browser software which helps to transfer information to our computer.

You are already familiar with the cell wall, the cell membrane (plasma membrane), the cytoplasm, the nucleus etc. What are the other parts you observed in the figure? List them.



To get more information, pictures etc., regarding cell - http://en.wikipedia.org/wiki/cell_biology

Read the following information to know more about each cell organelle.

Protoplasm and cytoplasm

All substances inside the cell membrane constitute the protoplasm. Cytoplasm is the part of the protoplasm excluding the nucleus. All factors required for life activities are present in the cytoplasm. Cell organelles are the specific parts seen in the cytoplasm to perform physiological functions.

Pic.4.2 Basic Science lesson

The Amazing World @ your Fingertips

You may have noticed http://en.wikipedia.org/wiki/Cell_biology given in your textbook. What does it mean? This is the address of the web page where the information about cell is stored. It is called the website address (URL).

Find out more information about cells on internet based on the points given below:

- ◆ Open Firefox web browser in your computer.
- ◆ Type http://en.wikipedia.org/wiki/Cell_biology in the address bar of the Firefox window (where we can see 'Search' or 'Enter address') and press Enter key.
- ◆ Now, the information about cells included in Wikipedia, the online encyclopedia, will be visible on the monitor (Pic. 4.3).

Note down the required additional information from this.

- ◆ Did you see 'Languages' on the panel on the left side of Wikipedia? Go through the list of languages given there. You can get information about cells in all these languages.

Web Browsers



Information from the internet is displayed in the form of web pages. The softwares which make this available are called web browsers. Firefox developed by Mozilla project, Web (epiphany) by GNOME project, Chrome (Chromium) by Google, Internet Explorer by Microsoft, Edge etc. are examples of web browsers.

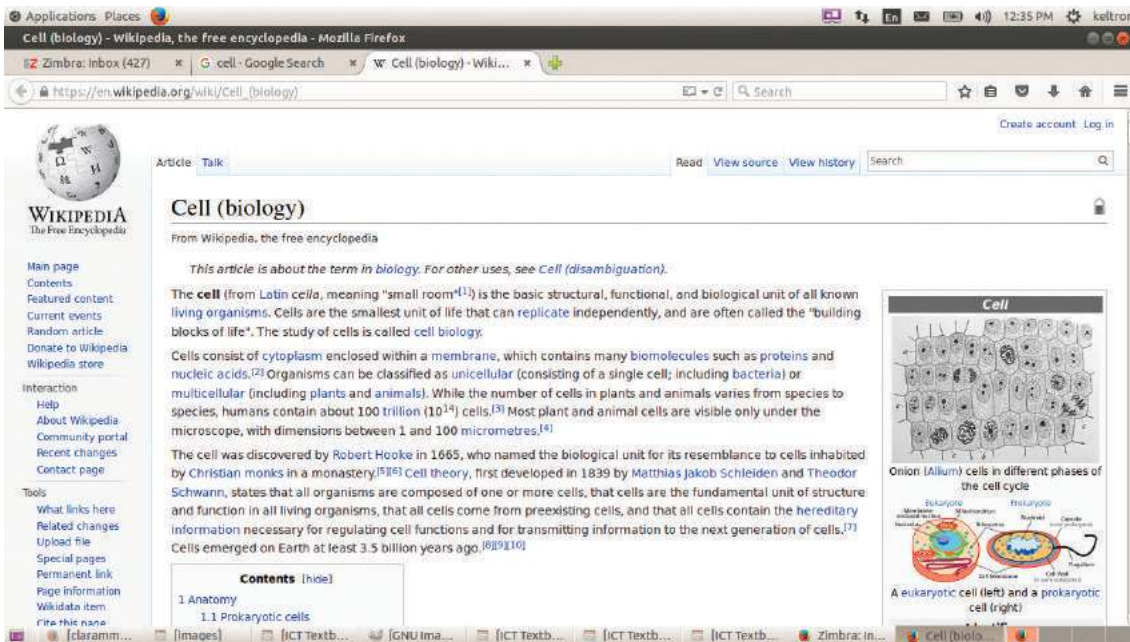

Pic.4.3 Wikipedia page about cell

Web pages and website address

We can gather the required information from the internet only if we know the name in which it is stored in the internet. The information stored in the internet has a specific address. It is called **website address**.

The collection of web pages which contains a variety of information which are mutually linked is called **websites**.

Website address is also called URL (Uniform Resource Locator).

Web portal

There are websites which act as ways to enter various websites related to a particular subject. These types of sites are called web portals. www.kerala.gov.in is a portal through which we can enter different sites of the Government of Kerala.

- ◆ Click on 'Malayalam' in the list of languages. Now information about cells will appear in Malayalam.

You are now able to visit a website if you get its web address of it.

We can see web addresses of various institutions, newspapers, eminent persons etc. if we go through periodicals, books etc. www.kerala.gov.in is the website address that contains official information about Government of Kerala.

Collect various web addresses of popular newspapers and institutions and visit their websites.

The first part of the names of the websites which you visited is www. It is the abbreviated form of World Wide Web.

World Wide Web

- ◆ World Wide Web is an important service which enables information communication through the internet.
- ◆ World Wide Web is a collection of crores of data stored in computers all around the world.
- ◆ In World Wide Web, crores of data, which are useful or not useful, are stored in web pages as documents, images, videos, sounds etc. which are mutually linked as well as not linked.
- ◆ Information from World Wide Web is available on any computer connected to the internet.



Activity 4.2 Searching for images...

As instructed in your Basic Science textbook, we have already found out some additional information. But, what should we do if we need different kinds of images of cells?

For this, we should know the addresses of websites in which the images of cells are stored, as we have discussed earlier.

The Amazing World @ your Fingertips

If the website address is not known, internet provides some other facilities to find out the information. These facilities are called Search Engines.

These search engines help us to find out without delay exclusively the required information, pictures etc. from the huge information repository in World Wide Web.

www.google.com, www.bing.com, www.duckduckgo.com, www.yahoo.com etc. are some of the search engines available on the internet.

Based on the provided stages of activity, collect different images of cells through search engines and save in your folder.

- ◆ Open the web browser and type the address of a search engine in the address bar (eg. www.google.com).
- ◆ While opening Google search engine, a window as shown in the Pic.4.4 will appear.

Some website addresses for you...

You can visit these website addresses:

- www.education.kerala.gov.in
- www.prd.kerala.gov.in
- www.itschool.gov.in
- http://india.gov.in
- www.dct.kerala.gov.in
- www.kstmuseum.com



Pic.4.4 Google search window

Some Search Engines

Accoona - China, America	Goo	- Japan
Baidu - China	rediff	- India
Biglobe - Japan	walla	- Israel



Ward Cunningham



Jimmy Wales



Larry Sanger

Wikipedia

Wikipedia is an online encyclopedia. The name Wikipedia is the mixed sound of the terms Wiki and Encyclopedia. This is a joint venture for making a free and complete encyclopedia in all languages. This project works with the support of a voluntary organisation, Wikimedia foundation. The content in the Wikipedia will always be independent and free of cost. The articles in the Wikipedia are prepared by service-minded users all over the world who are working voluntarily and collaboratively.

An American, named Ward Cunningham is the person who initiated the concept of Wiki and developed the software. Using the software Wiki Wiki Web developed by him in 1994, the website www.c2.com is established on 25th March 1995. Wiki means websites which give freedom and facility to add, delete and modify any information by any user. Since adding information in Wiki is very easy, Wiki became a fine means for collaborative writing. The word Wiki is also used to denote software which provide facility for making notes, articles and other writings through a collaborative effort.

Jimmy Wales and Larry Sanger started the project Wikipedia on 15th January 2001. According to 2015 statistics, Wikipedia has editions in more than 280 languages. The English edition was produced under their leadership. Wikipedia has editions in 20 Indian languages including Malayalam.

- ◆ Type the word 'cell' (search word) in the search box of the search engine window. (For getting information from internet, it is enough to search by giving a related search word).
- ◆ Now, the list of websites which contain the information about cells will appear (Pic.4.5). To get images of cells from this, click on Images seen just below the search box.

The Amazing World @ your Fingertips



Pic.4.5 Google search list

- ◆ You have seen that pictures are displayed on clicking on Images.
- ◆ You can see cells of different categories (Human, Plant, Animal, etc.) in the first row (Pic.4.6). You may click on the category in which the required pictures are found.

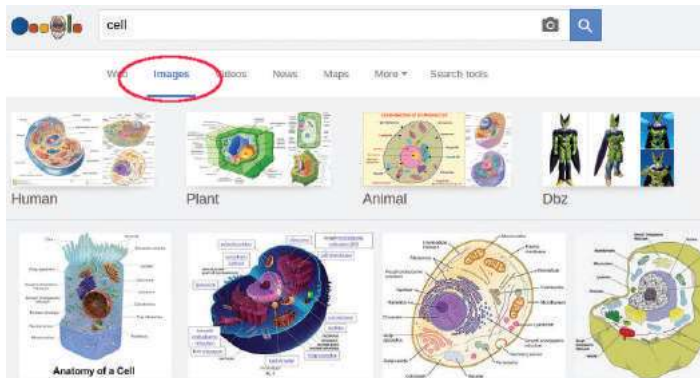

Pic.4.6 Pictures of cells in different categories

Can all the images seen on internet be copied and used?

Some websites give us the right to copy the pictures, but some others do not. Certain others give us the right on certain conditions. While we collect pictures to be used after modification, we should download only those which offer us copyright.

Google also provides the facility to search for pictures which do not have copyright.

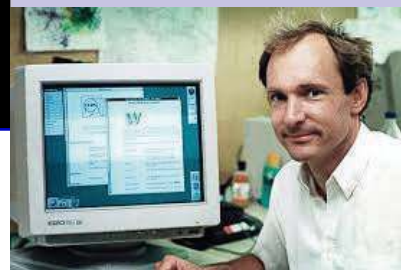

Tim Berners Lee

Sir Timothy John Tim Berners Lee is the founder of World Wide Web. Lee, who started the method of sharing information through mutually linked hypertext documents, put forward the concept of World Wide Web. He also designed a web browser that makes the web pages visible. He is the director of World Wide Web Consortium (W3C) which monitors the growth of the web. Lee is also the founder of World Wide Web Foundation.

He was born on June 8, 1955 in Britain.



Marc Andreessen

Marc Andreessen developed a graphical browser which can handle images and sound apart from characters in the internet. He developed the browser Netscape navigator. He was born in the year 1971 in Iowa State in America.

Copyright and Copyleft

The information, pictures, movies, sounds etc. available on the internet are prepared as a result of the effort of different people. There may be some restrictions to use it on our own. Some of them have an exclusive right to the person who developed it based on the copyright law. But some are free for everyone to use. So while we search and use information from internet, we must be aware whether it is free to use or not. If it is not free, we have to procure permission from the person or institution concerned to use it.

- ◆ If you click on the search tools below the search box, usage rights menu will appear as shown in the Pic. 4.7.

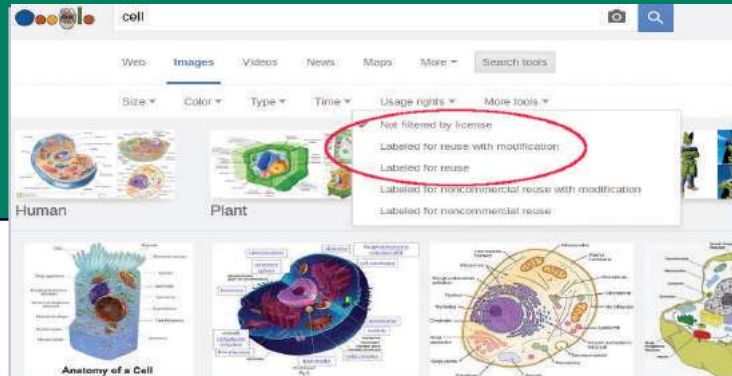

Pic.4.7 Page in which usage rights are displayed

- ◆ Select 'Labelled for reuse with modification' from the list displayed while clicking 'usage rights'. Now, we can access pictures which are free to use or modify.
- ◆ Click on the required picture and open it. Then right click on the mouse and select 'Save Image As' from the menu and save the picture for further use.

Activity 4.3 Find the meanings of words

You might have come across various situations where you had to refer to dictionaries to get the meanings of words while learning lessons in English and Hindi.

Various online dictionaries in different languages are available at our fingertips in this era of information communication technology. We shall familiarise ourselves with some of the free language dictionaries.

- ◆ Visit the websites - <http://ml.wiktionary.org>, www.olam.in. Note down the difficult words that you come across in your English Reader find their meanings and write them down. Refer to other dictionaries and check the meaning.
- ◆ These websites contain the meanings of not only English words but also Malayalam words. This is prepared using the information gathered from various Malayalam dictionaries. It expands

The Amazing World @ your Fingertips

constantly with the joint effort of a number of language loving volunteers across the state.

- ◆ Facilities for translating the meanings of words and sentences to English and Indian languages like Malayalam, Hindi, Tamil, Kannada, Telugu etc. and to foreign languages are available on the internet.

Can we use these online dictionaries without a computer or an internet connection? There are solutions to this too in this era of tablets and smart phones. Offline versions of such dictionaries are now available as mobile apps in mobile phones and tablets.

Shopping can be done sitting at home

We usually buy rice, vegetables and other things by going to shops. Do you know that these things can be bought without going to shops?

There are many commercial sites on the internet. The trade using these commercial sites is called **Online Shopping**. We can order the required goods by giving our postal address in these shopping sites. We can pay the cost of the goods by various methods. The goods will be delivered to the given address by post/courier service. Things are very easy..., aren't they? There are websites which provide such facilities. Find out those important sites with the help of your teacher.

While using the Internet...!

- ◆ While visiting websites, get the correct web address and type it in the browser without mistakes.
- ◆ Sometimes, errors may occur while typing the web address. You may be led to wrong websites or may be cheated since there are people who utilise these errors for such purposes.
- ◆ Sharing and uploading pornographic pictures and videos are offences under various cyber laws. The websites regularly visited by you can be observed and information about your interest, character etc. can be collected as part of enquiries by the authorities.



Vinton G Cerf

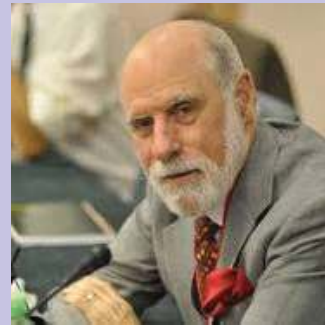

Vinton Cerf, who was the director of ARPANET project (the prototype of the internet) is known as the father of the internet. He played an important role in developing TCP/IP (Transmission Control Protocol / Internet Protocol) which is the basic standard for transferring information on the internet. He was born at New Haven in America in the year 1943.



Mobile Apps for anything and everything....

In addition to finding the meaning of words, we can use smart phones for many other day to day activities like reading the news, performing banking transactions, finding routes, reserving tickets, finding the bus and train timings etc. Mobile Applications (App) are now available to help us. Apps became popular because they are easily available in mobile phones as internet enabled services.

Android Play Store of Google, App Store of Apple, Windows Phone Store of Microsoft etc. help to install Apps easily.

While using Mobile Phones....

- ◆ Using mobile phone while driving will lead to accidents. If you see someone using it while driving, remind them of this danger.
- ◆ Taking photos and sharing them with an aim to defame persons or institutions are offences. Remember that taking photos without one's permission is also wrong.
- ◆ Messages which offer gifts, lottery etc. have chances of cyber spoofing. Don't react to such messages.
- ◆ Creating false and fake messages which cause defamation to others or stand against national interest or generate rivalry among caste/religion/class is an offence. Storing such message in mobile phones, sharing them etc. are also offences.

Cyber Crimes

Cyber world is a term that generally refers to the use of the modern information communication devices like computer, internet, mobile phone etc. All activities done using the information communication devices like mobile phones, computer, internet, camera etc. which are against the law or which causes harm or defamation to persons, institutions, technical facilities etc. are considered as cyber crimes. You will study more about this in the higher classes.



Internet of Things (IoT)

Are the electrical equipments at home switched off? Is the valve of the gas cylinder closed? Is the door closed? At times, you might be worried by such thoughts. Sometimes, you would be relieved only when you check it going back home. Now, electronic equipments at home will observe all these things. They will take care of these things which we have forgotten. Mobile apps and other facilities are available for these purposes. In short, phones/tabs will become multipurpose devices in the near future. Internet of Things (IoT) means observing and controlling equipments connected to the internet like this.



Let's Evaluate

1. The facility that controls the information repository on the internet is:
 - (a) E-Commerce
 - (b) E-Governance
 - (c) World Wide Web
 - (c) E-Mail
2. is a web browser.
 - (a) Mozilla Firefox
 - (b) Gimp
 - (c) Geogebra
 - (d) GCompris
3. The Internet is:
 - (a) Network of computers
 - (b) World Wide Web
 - (c) The mega computer network spread all over the world and the facilities provided by it.
 - (d) Information communication through computer networks.
4. The facility which helps to find out information, pictures, etc. by searching the internet is:
 - (a) World Wide Web
 - (b) Browser
 - (c) Search Engine
 - (d) Wikipedia
5. The trade using the facilities on the internet is:
 - (a) E-mail
 - (b) E-Governance
 - (c) E-Commerce
 - (d) Chat

6. The website which can be used free of cost for collecting information:
- (a) www.wikipedia.org
 - (b) www.bbc.com
 - (c) www.cnn.com
 - (d) www.rose.com



Follow-up activities

1. Prepare a note identifying the various services available through the internet.
2. Examine the Malayalam dailies and collect their website addresses and visit their internet editions.
3. Collect images of pyramids in Egypt from the internet and save them in your folder.
4. Collect the details of various types of soil from the internet, copy them to the word processor and save them.
5. Find out the Malayalam meanings of the new words in your English and Hindi textbooks by using the online dictionaries in the respective languages.



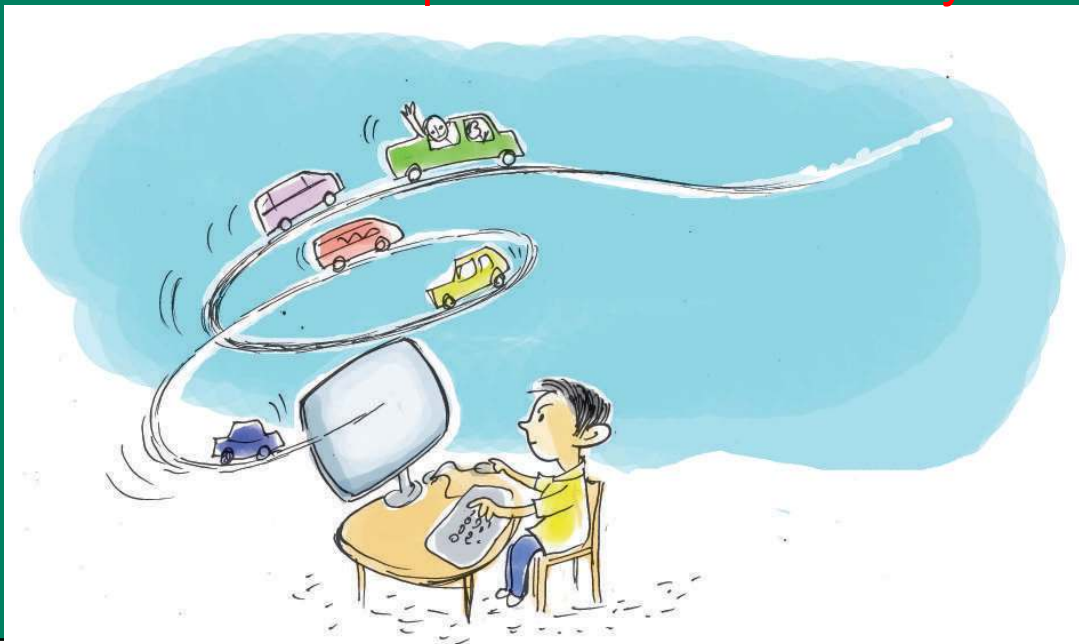

5

My Own Computer Game

By learning this unit, the learner will be able to:

- ◆ open 'Scratch' software and change the background/stage
- ◆ add characters in 'Scratch' background/stage
- ◆ animate the characters in the background/stage
- ◆ create animations and games using 'Scratch' software

Don't you like computer games? There are a number of computer games in your computer which are very helpful for learning and recreation. Are you familiar with 'Educational suite GCompris', 'Potato Guy' etc.? Do you know how these games are prepared?

Some of these games and animations are included in the 'School Resources' folder in your computer. Try to play these games with the help of your teacher. The window of an interesting game in this folder is given in Pic 5.1. This game is prepared using the software 'Scratch' which is included in your computer.

What should we do to prepare a computer game like this? You can see the following features in this game.

- ◆ A car racing track is given on the background and a car which can be moved along the track is included.
- ◆ The car can be moved using the Arrow keys on the keyboard.
- ◆ Instructions are given to stop the game when the car moves out of the track.

You can do all these using 'Scratch' software. Let's do these activities in the given order.

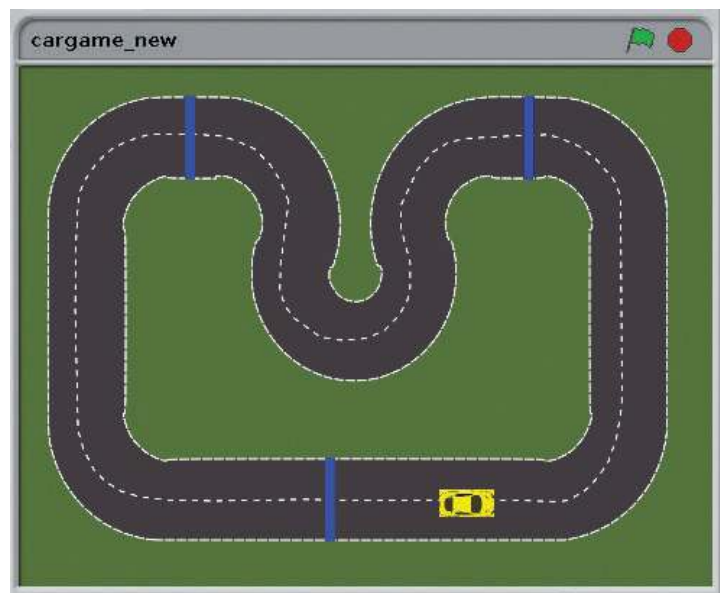
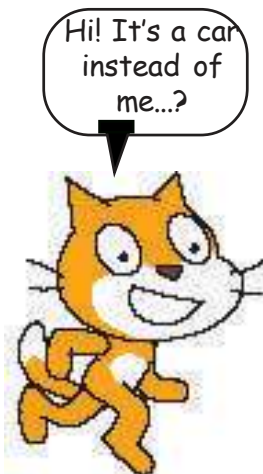

Pic. 5.1 Car game screen

Scratch: 'Scratch' is a software used to create animations, cartoons and games easily.

Stage: Stage is the background appearing when we open the scratch window. The background will most often be white. You can change the background colour as you like.

Sprite: The characters on the background of a Scratch window are known as Sprite. Usually a cat appears as a sprite when the Scratch window is opened. The software provides facilities to make alternations in sprite.

My Own Computer Game

Activity 5.1 Edit 'Stage and 'Sprite'

Open 'Scratch' software and edit the 'Sprite' adding a car in it. Include a car racing track as the background. (You can select the picture of a car racing track and a car from the 'Images' folder in the 'School Resources' of your computer. You can also add pictures drawn using Gimp Software)

I am Sprite. Let me run through this white background.

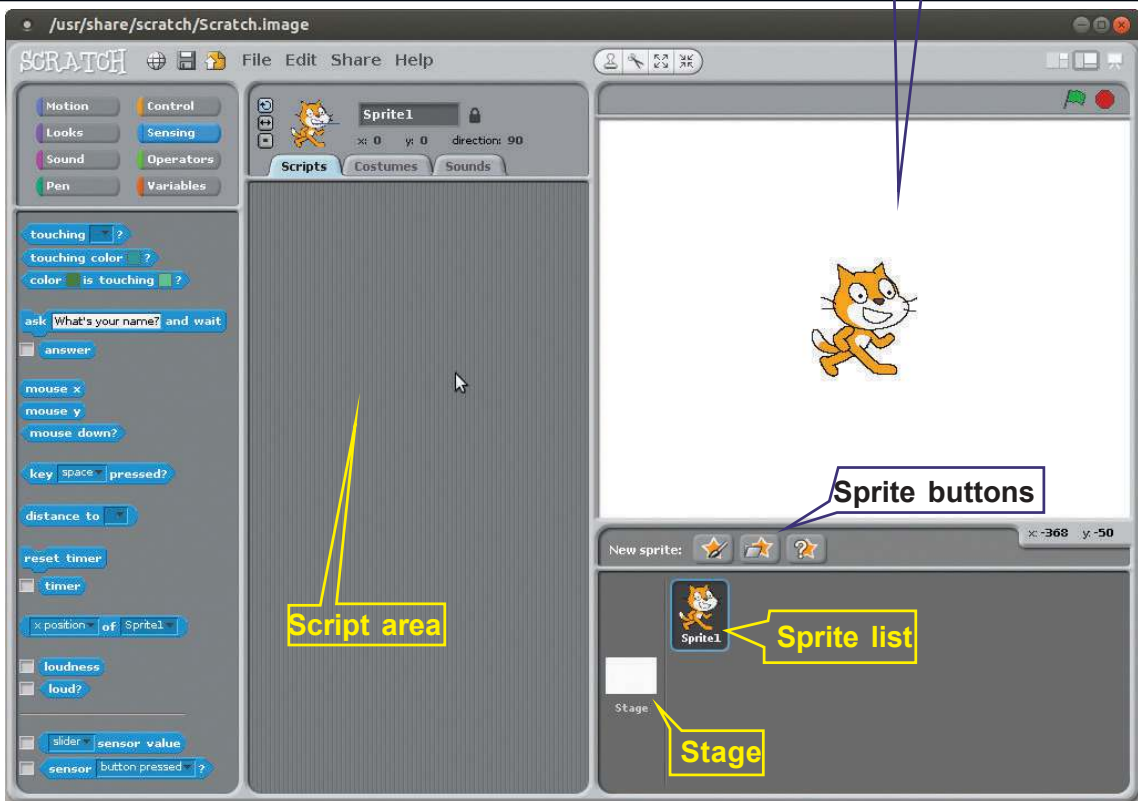

Pic. 5.2 Scratch main window

Order of activity

- ◆ Open 'Scratch' software.
- ◆ **To add new Sprite:** When we open the 'Scratch' window, usually a cat appears as the Sprite. Facilities to alter the Sprite and add new pictures are provided in the 'Scratch' window. For this, you can use the 'New Sprite' buttons given above the Sprite List. (See Picture 5.2 and Table 5.1 for help).



New Sprite	Use
 Paint new Sprite	To draw and import New Sprite
 Choose new Sprite from File	Include pictures from Costumes Gallery
 Get surprise Sprite	Use random pictures as Sprite

Table 5.1 Usage of icons



Delete Sprite : To delete a Sprite, make a right click on 'Sprite' and select delete option.

To change the background/stage : White background is usually seen when the Scratch window is opened (Pic 5.2). To change the background, click on 'Stage' in the 'Scratch' window. Now, you can see the tab 'Costumes' in the 'Script area' changing to 'Backgrounds' (Pic 5.3). 'Background1' will appear in the 'Script area' when you click on the Background tab. Click on the Edit button to change the background. 'Paint Editor' window will appear (Pic 5.3) on the screen.

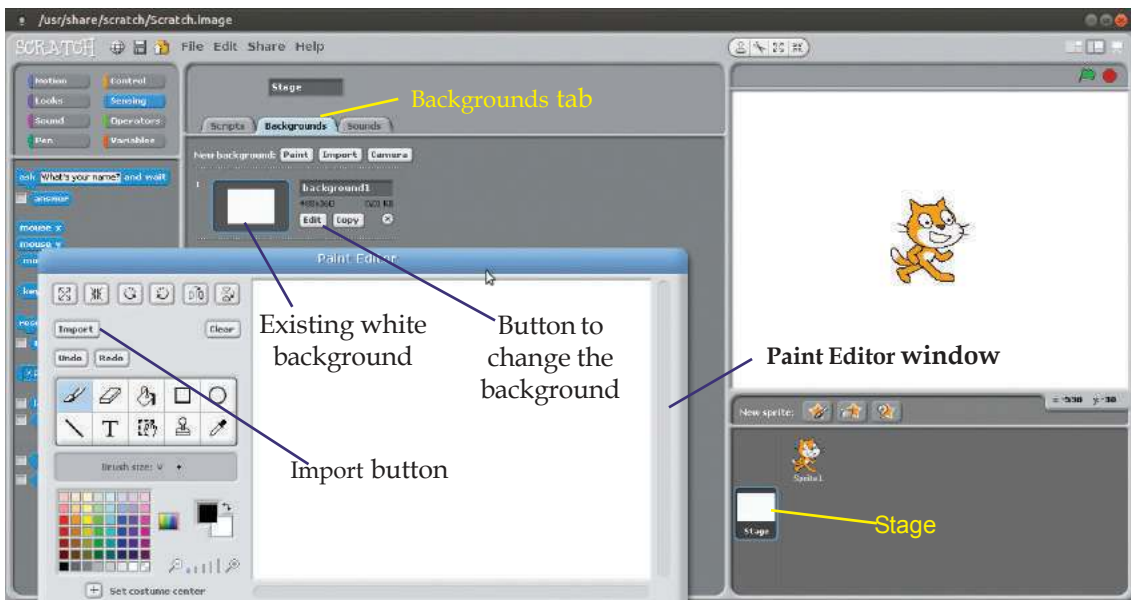

Pic. 5.3 Changes made in the Sprite window to change the background

My Own Computer Game

- ◆ New background picture can be included using the 'Import button' in the 'Paint Editor window'.

Open 'Scratch' software according to the instructions given above and include the background given in Pic. 5.1 (car racing track) and the Sprite (car). Make a sub folder named 'Program' in your folder. After completing the activity, save the file in the sub folder.

Activity 2 Animate the 'Sprite'

You have noticed a car racing track given as a **stage** and a car as a **sprite** in Pic 5.1. After the preparation of the stage and the sprite, let's make the car move using the keyboard.

You may make use of the 'Block Pallet' given in the 'Scratch' to animate and move the 'Sprite'. To make the 'Sprite' move using the keyboard, use the 'Motion', 'Control' and 'Sensing' tabs in the 'Block Pallet' and follow the instructions.

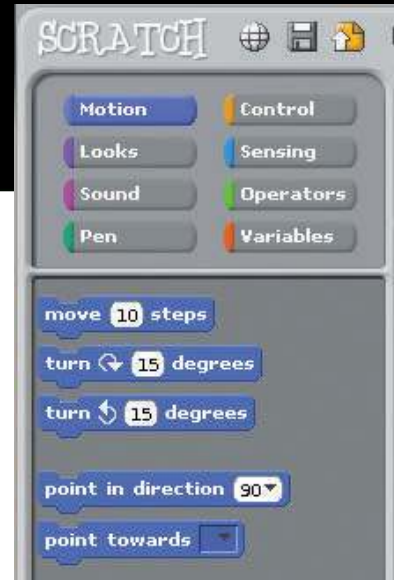

Pic. 5.4 Block pallet

Extended Activity

Open 'Scratch' Software and include an aquarium as the background/stage. Add fish as characters in the background.

Game Instructions (Block Pallet)

Programming instructions in the 'Scratch' Software are included in the 'Block Pallet'. They are given in the tabs: Motion, Control, Looks, Sensing, Sound, Operators, Pen, Variables etc. (Pic 5.4). Pic 5.4 contains instructions in the Motion tab. The common features of the instructions of each tab are given below.

Motion: To move the 'Sprites' in the 'Scratch Stage' in different ways.

Control: To control the movements of the 'Sprites'. Use the instructions in this tab to decide when and how long the Sprite should move.

Looks: The size, interaction, whether to hide or show the 'Sprites' etc. are arranged in this tab.

Sensing: To control the movements of the 'Sprites' according to the instructions given in the keyboard or the colour of the monitor.

Sound: To control the audio of the 'Sprites'.

Operators: The instructions to solve mathematical problems and to compare them are included in this tab.

Pen: To draw figures on the 'Scratch' screen.

Variables: To include variables in the project. For example, we have to include variables to decide the score of the game.

Don't forget to drag and drop each and every code segment.



The car in the 'Scratch' stage will move forward when the 'Up Arrow' key is pressed. Press 'Down Arrow' key to move the car backward, the 'Right Arrow' key to move it to right and the 'Left Arrow' key to move left. To perform these actions, arrange the instructions as given below, in the Script Area .

To move the 'Sprite' forward using the 'Up Arrow' key, arrange the necessary code segments in the Block Pallet, as shown in Pic 5.5. All these code segments are available in the various tabs in the Block Pallet. You can make use of Table 5.2 for help.

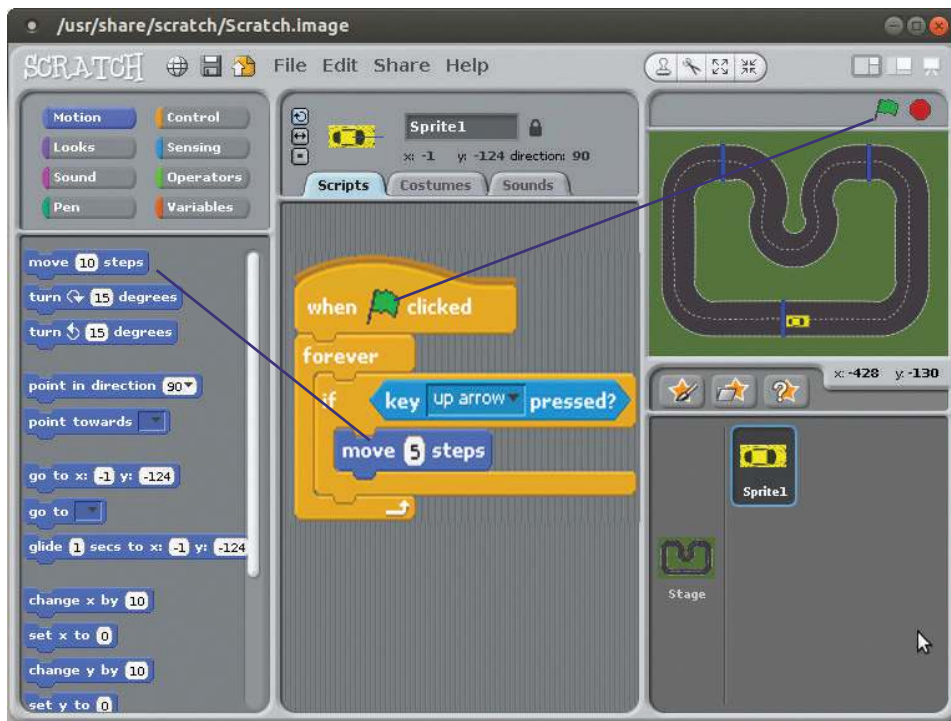

Pic. 5.5 The instructions arranged in the window which help us to make the car moving, using 'Up Arrow' key

My Own Computer Game







No.	Code segment	Group/ Type	Use
1		Sensing	To give instructions using keyboard (to sense it)
2	 A	Motion	To move the car 5 steps forward. To change the value of the rounded part using the letter 'A'.
3	 A B	Control	To activate a set of codes on certain occasions. This code segment is used to move the car forward when we use the 'Up Arrow' key. For this, include first code segment in part 'A' and the second code segment in part 'B'.
4	 A	Control	It is used to continue the activity till the game ends. In the given example, the 'Sprite' moves forward when the 'Up Arrow' key is used till the game ends. See how the third code segment is included in part 'A'.
5		Control	To start the game when we click on 'Start Button' in the 'Scratch' window.

Table 5.2 Code segments and use

You have prepared the instructions to make the 'Sprite' move forward using the 'Up Arrow' key as given in Pic. 5.5. Now, click on the 'Start'  button in the 'Scratch' window and play the game. You can also make the car move to both sides and backwards. How can the codes be prepared for these movements?

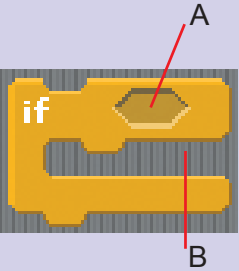

Script Segment	Use
The car moves backwards when the 'Down Arrow' key is pressed.	
The car turns left when the 'Left Arrow' key is pressed.	
The car turns right when the 'Right Arrow' key is pressed.	

Table 5.3 Script segment and use

Prepare the codes with the help of Table 5.3 and Pic 5.6. Add them to the 'Scratch' file already prepared.





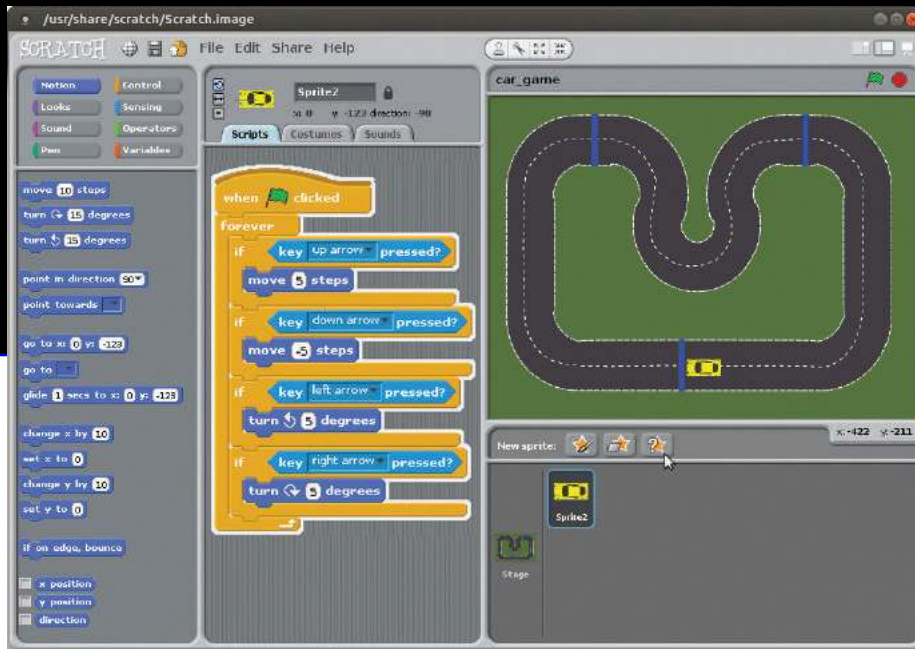



Oh! Now the car can be moved to all sides.

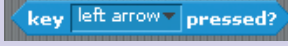

Pic. 5.6 The window having the instructions to move the car to all directions

Now, you have prepared the game as shown in Pic 5.6, haven't you? Let's start the game using  button. Then complete the Table 5.4.

Sl. No.	Code Segment	Group/Type	Use
1			To inform the program that the Down Arrow key is pressed (If we make changes in the marked part, we will get the code segments 2, 3 and 4).
2			
3		Sensing	
4			
5			To move 5 steps backwards.
6		Motion	To turn the car 5 degree left.





My Own Computer Game			
7			
8			To bring back the car to the starting point, where the game started.
9			To turn the car towards the direction where the game started.
10			To give one second pause between two actions.
11			To hide the car temporarily.
12			To make the car visible again.

Table 5.4 Different code segments and their uses

Activity 5.3 When the car moves out of the track

You have prepared the code segments for moving the car through the track with the help of the arrow keys, haven't you? Add a segment to end the game, when the car moves out of the track. Bring the car back to the starting point.

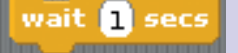
You can use the techniques like 'Colour Sensing', 'Show', 'Hide' etc. in the 'Sprite' software. See the instructions arranged in Pic 5.7. Add these instructions to the project prepared earlier and activate it. You can see that the game ends when the car runs out of the track and goes back to the starting point.

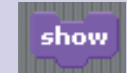
Extended activity

Open the 'Scratch' Software and include an aquarium as the stage/background. Include fish as characters on the stage and make them move using the keys on the keyboard.

Scratch Online

The animations, game and other resources prepared using the 'Scratch' software can be uploaded. You can also view the resources shared by other people. The website <https://scratch.mit.edu> and the online group scratched.gse.harvard.edu will help you to upload your files. This online group started in 2009 is known as 'ScratchEd'. You will share the animations and games you have prepared with the help of these sites, won't you?

Colour Sensing

Now, you are familiar with the instructions given to help the program to identify the pressings of the key. The instructions to identify the colours on the screen are also available in the Scratch software. These instructions are known as Colour Sensing code Segments. The code segment to recognize a colour touching another colour is shown in pic 5.7. This code can recognize when the colour of the central part of the car touches the road outside the track. It is possible in the following way

- ◆ Drag the Colour Sensing Instruction into the section needed in the game code.



- ◆ First, click on the first (A) cell. Now, the mouse pointer will become the colour picking tool. Then, click on the black central part of the car. You can see that the 'A' cell has become black. Click on the 'B' cell and then click on the colour of cell out of track. The game ends when the colour of 'A' cell touches the colour of the 'B' cell. Play the game.

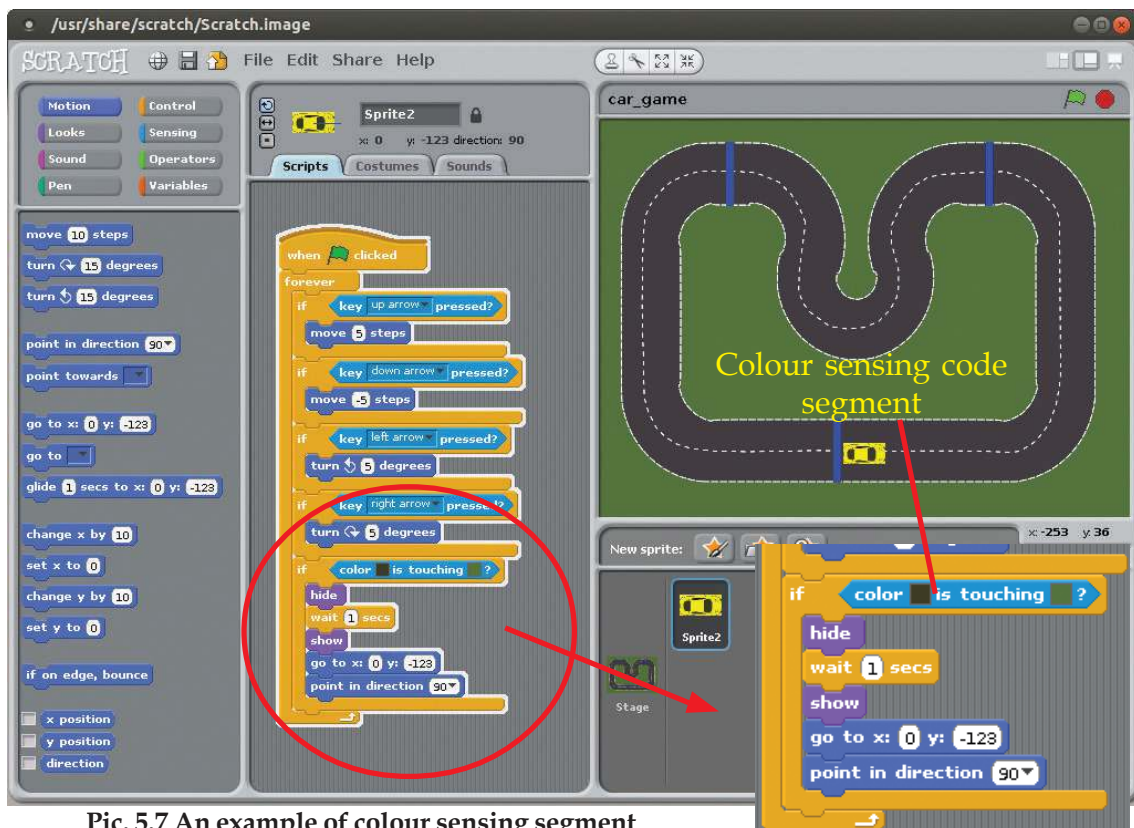

Pic. 5.7 An example of colour sensing segment

My Own Computer Game

Activity 5.4 Changing costumes

You have prepared the car game, haven't you? Did you notice that the running car and the static car are of the same shape? Can the running car be made attractive by making slight changes in its shape? For this, you have to create or include a new car using the 'Costumes' tab. The steps to create Costumes are given below.

- ◆ Select the 'Sprite' (car) and click on the 'Costume' tab. The existing car will be visible as 'Costume1' under the Costumes tab. (Pic 5.8)
- ◆ Press the Copy button below the 'Costume1'. You will get a copy of 'Costume1' with the name 'Costume2'. (The car in Pic 5.8 is created in this manner.)
- ◆ Click on 'Edit' button to make changes in 'Costume2'. Now, 'Paint Editor' window appears. You can edit the picture using the tools in the 'Editor'. (See the three grey bubbles in 'Paint Editor' in Pic. 5.8.) Then click on 'OK' button.

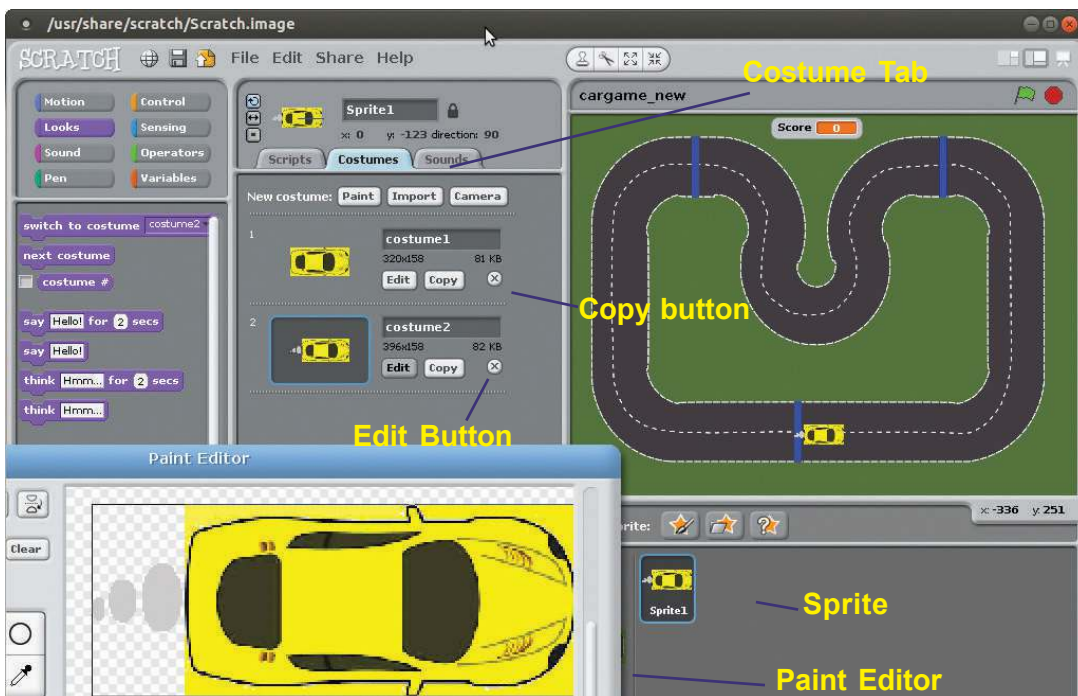

Pic 5.8 Paint Editor window

Steps to include the changed 'Sprite' into the program are given below.

Programming language

All the softwares including the 'games' in the computer are created with the help of different programming languages. Python, C++ etc. are examples of programming languages. But these languages are not easy to use, because the instructions should be learnt byheart. If we can make a program without learning the instructions, how easy it would it be! This is also possible. Visual programming language helps us to do this. 'Scratch' is one such programming language.

- The code segment used to make the car move forward is shown in the first cell in Pic 5.5. You may change this as in the second column and add it in the existing program.

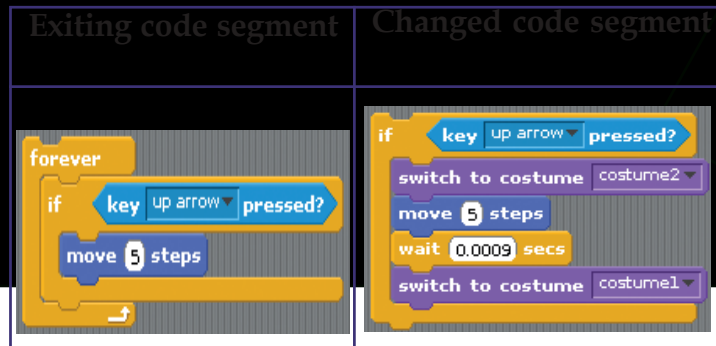

Pic. 5.5 Changing of a code segment

Now, play the game. You can see cars in different shapes when in motion and stationary.





You can make more changes in the program of this game. Scoring, using more than one car etc. are some of the possibilities. Try it.

Not only games, but all the software you use in your computer are developed with the help of different programming languages. Writer, Gimp, Calc etc. are developed using different programming languages. Don't you want to prepare games and animations like these? The car game we have prepared can be a beginning.





Let's Evaluate

- Which of the given instructions can be used to turn the car 30 degrees right?

a) 	b) 
c) 	d) 
- How can the background/ stage of 'Scratch' software be changed?
 - Select 'Sprite' and click on 'Backgrounds' tab to change the stage.
 - Select 'Stage' and click on 'Backgrounds' tab to change the stage.

- Some codes are there in the table given below. Complete the table.

Scratch instructions	Similar codes
	If (Down arrow key is pressed) Backwards (5 steps)
	
	



Follow-up activities

- Select pictures from 'Costumes Gallery' of 'Scratch' software. Using these pictures, prepare an animation in which a bat flies in front of a house.
- Prepare the animation in which an aeroplane flies in the sky.
- Prepare the animation of a person dancing. Select and use pictures from 'Sprite Gallery' of 'Scratch' software.
- Include another car in the car game that you have already prepared. The new car should function when the keys 'W, A, S, D' are used.





6

Data Analysis Made Easy

By learning this unit, the learner will be able to:

- ◆ consolidate and analyse data easily and effectively with the help of software.
- ◆ identify and note down the rows, columns, cells and cell addresses in LibreOffice Calc.
- ◆ tabulate data in LibreOffice Calc.
- ◆ add new rows and columns to a table created in LibreOffice Calc.
- ◆ find the sum of the data using 'Sum Function'.
- ◆ copy number series and formulas to an adjacent cell.
- ◆ arrange tables in ascending and descending orders.
- ◆ prepare graphic presentations of data in LibreOffice Calc.

Oh! It went wrong this time too! Collecting data from houses was easier. Let's try once more.

Yes; How can we tabulate the data from a hundred questionnaires and analyse?

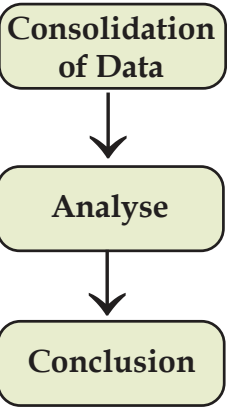

Have you understood the problem faced by Anu and Amina? They are trying to consolidate and analyse the questionnaires collected as part of a project. They have a wide range of data with them, collected after visiting a number of families. What are the activities they have to do now? Notice the given procedure.

It is indeed a difficult task to classify, tabulate and analyse the data collected from more than one hundred questionnaires and to reach conclusions. If we do it with the helps of a computer, it reduces our work load and makes the analysis easy. Spreadsheet softwares are developed with a view to perform these kinds of activities. Gnumeric, Calligra Sheets, Microsoft Excel, OpenOffice.org Calc, LibreOffice Calc, etc. are examples of spreadsheet software.

While doing academic projects...

There are a lot of academic projects assigned in our textbooks. Academic projects can be done as part of the lessons you have to study or based on a particular social issue. Scientific and well planned data collection, consolidation, analysis and making the right inferences are the features of project-based learning. Findings of the study should be published as a report, presented and the follow-up activities planned systematically. Different softwares help us to do these works easily and accurately. Here, Anu and Amina are doing an academic project given in Std VIII Basic Science textbook in the unit titled '**Let's Regain our Fields**'. You can select relevant academic projects from your Science textbook or from any other textbook.

Activity 6.1 - Let's identify the cell address

Open the LibreOffice Calc in your computer and observe it.

Don't you see a lot of small rectangular boxes in rows and columns? These boxes are called cells. Click the mouse on each cell. Do you see that the cell you clicked becomes more bright? This is called cell pointer. (Pic. 6.1). You can change the position of the cell pointer using the arrow key in the keyboard also. We can type and add information in the cell where the the cell pointer is.

A cell is identified by its cell address. Cell address is the combination of column header and row header. Now, complete the table (Table 6.1) given below.

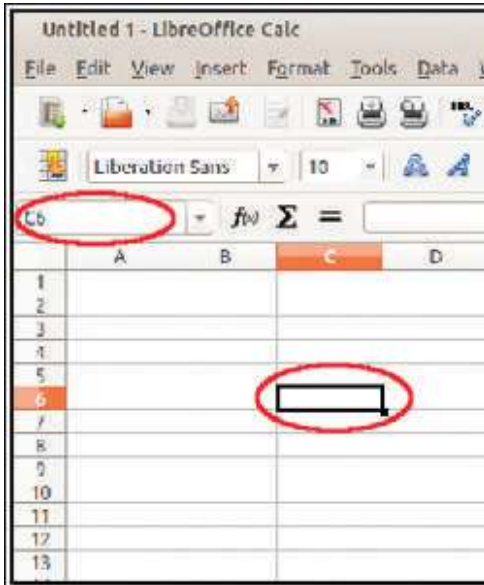

Pic.6.1 Cell Pointer, Cell Address

Name of column	Name of row	Cell address
C	6	C6
	12	H12
M	34	
AJ		AJ110
		K65

Table 6.1 Cell address formation



Pic. 6.2 Visicalc

Spreadsheet Software

VisiCalc is the first spreadsheet program prepared for personal computers. The first edition was released in 1979. VisiCalc is the acronym of 'Visible Calculator'. It was the product of a joint effort by Dan Briklin and Bob Frankenstein. Spreadsheet softwares like Multi Plan and Super Calc were in use at that time.



Pic. 6.3 Dan Briklin



Pic. 6.4 Bob Frankenstein

What do you see just above the left end of the column header? Isn't it the address of the cell you have selected? (Pic.6.1) Now, select different cells and identify their cell addresses.

Activity 6.2 - Let's add a new column and row

Not the serial number.... It is the name of the row

Everyone of us has one's own name. It helps others to identify us. Like that, each row has its own name (Row Header) by which the row can be identified. You have seen numbers (1, 2, 3...) given on the left side of the row. Don't mistake them as serial numbers. They are the names of the rows. Now, try to find out the names given for columns in the column header. Look at the letters A, B, C, D... given as the column header. Numerals are used to name the rows and English letters are used to name the columns.

Amina and Anu have categorised the data collected for their academic project. Now, they are consolidating the data using LibreOffice Calc. The model of the table they have prepared is given below (Pic. 6.5).

	A	B	C	D	E	F	G	H	I	J	K
1	Questionnaire Consolidation										
2	Sl No	House No	Total Land (In Acre)	Measure of Land Used (In A)	House Name	Quantity of Vegetables Produced (in Kg)					
3						Spinach	Cucumber	Ladies Fing	Beans	Others	Total
4	1	367	1	0.8	Shanibhavan	29	67	43	22	77	
5	2	695	0.6	0.25	Chengala	22	12	8	13	10	
6	3	276	2	1.1	Pathuthara	53	76	12	33	68	
7	4	342	0.85	0.4	Snehtheeram	10	31	0	34	12	
8	5	654	2.2	0.9	Sarang	22	45	35	54	29	
9	6	345	2	1.5	Vallikalil House	35	89	30	67	74	
10	7	134	5	2.5	Rahna Manzil	61	123	45	96	86	
11	8	876	5.6	2.9	Manukkara	78	85	98	48	75	
12	9	791	3.5	1.7	Vatakkevedu	37	56	60	25	12	
13	10	765	0.45	0.1	Saketnam	1	5	2	0	2	

Pic.6.5 Model of the table to be prepared

Open the LibreOffice Calc in your computer and prepare a table like this. Give a suitable name for the file and save it in the sub folder Docs.



How can we help Amina and Anu? They want to add house owner's name to the left of column D (House Name). What should we do for this? Do the following activities in the given order.

Data Analysis Made Easy

- ◆ Click on any one of the cells in the column 'House Name'.
- ◆ Select 'Column' from Insert menu (Pic.6.6)

Where did you add the new column? Now give the heading 'Name of the House Owner' at the top of the new column and add the names of the house owners in the columns below that. Can you guess where the new column will be added, if the cell pointer is in the column 'Measure of Land Used'? Do it in the computer and make sure that your assumption is correct. Now, write below how to make new rows.

- ◆
- ◆

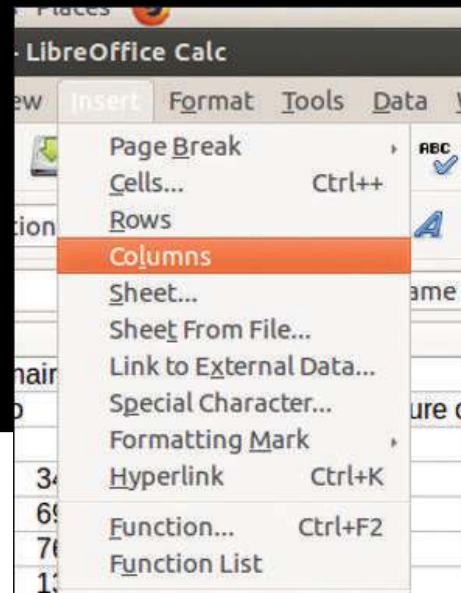

Pic. 6.6 Adding a new column

Multiple ways to add rows and columns

You can insert a new row in a spreadsheet. Right click on the row header just below where you have to insert the row. You will get a pop up menu (Pic. 6.7). You can select suitable options from it. Try to add a column in the same way. You can add a row or column by using  buttons in the tool bar (Pic 6.8). How will you delete an unwanted column or row? It can be done by a right click on the header of the row or the column, we want to delete. Try to delete a column or a row you don't need in the table. Find out the options available on the tool bar.

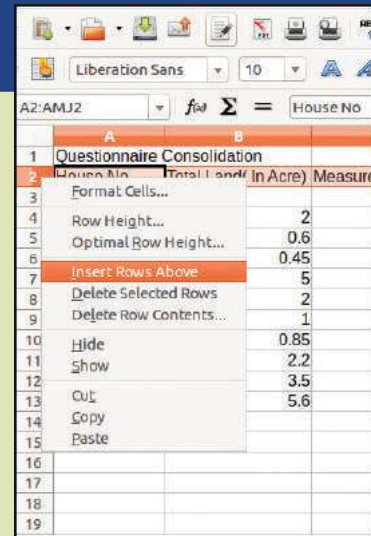

Pic.6.7 Adding new row

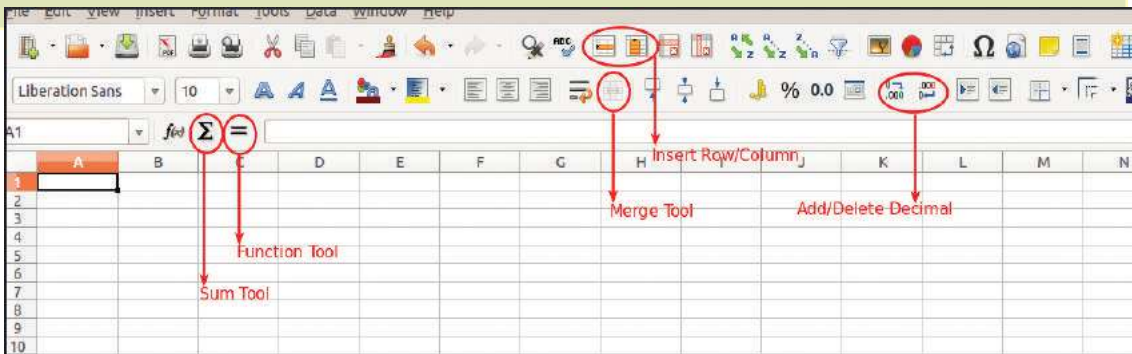

Pic.6.8 Tools in Libreoffice Calc

Add serial number

It will be better to add serial numbers in the first column of the table. How can we do this? Add a new column at the beginning of the table. Do you have to type all the serial numbers in the column? Let's follow the process given below and find out.



- ◆ Type '1' in the first cell.
- ◆ Click on the cell and select it.
- ◆ Move the mouse pointer towards the right bottom corner of the cell. What change can you observe?
- ◆ Have you noticed that the mouse pointer changed into '+' mark? This is called 'Fill Handle'. Fill handle helps you to copy data or formulae to the adjacent cells (Data Fill).
- ◆ Now drag the pointer downwards. How easy is it to add serial numbers!

Activity 6.3 - Let's find the sum

Pic. 6.9 given overleaf is a page in the project diary of Amina. How far has their work progressed? What are the facts that they have to find out as part of the analysis? Read the diary entry carefully.

Fill Handle : to make any series easy....!

'Fill Handle' in the LibreOffice Calc can be used not only to add serial number, but also to add series of months, weeks and days. Open a Calc window and type 'Sunday' in a cell and try using 'Fill Handle' tool. You can see the days from 'Sunday' to 'Saturday' in the cells below. Try month and date just like this. How can we make a number series like 2, 4, 6...? Type '2' in the first cell and use the 'Fill Handle' tool. Type '2' in the first cell and '4' in the second and select both of them and drag downwards using the 'Fill Handle' tool. What changes do you notice? Next, make a number series of the numbers below hundred which is divisible by 4.

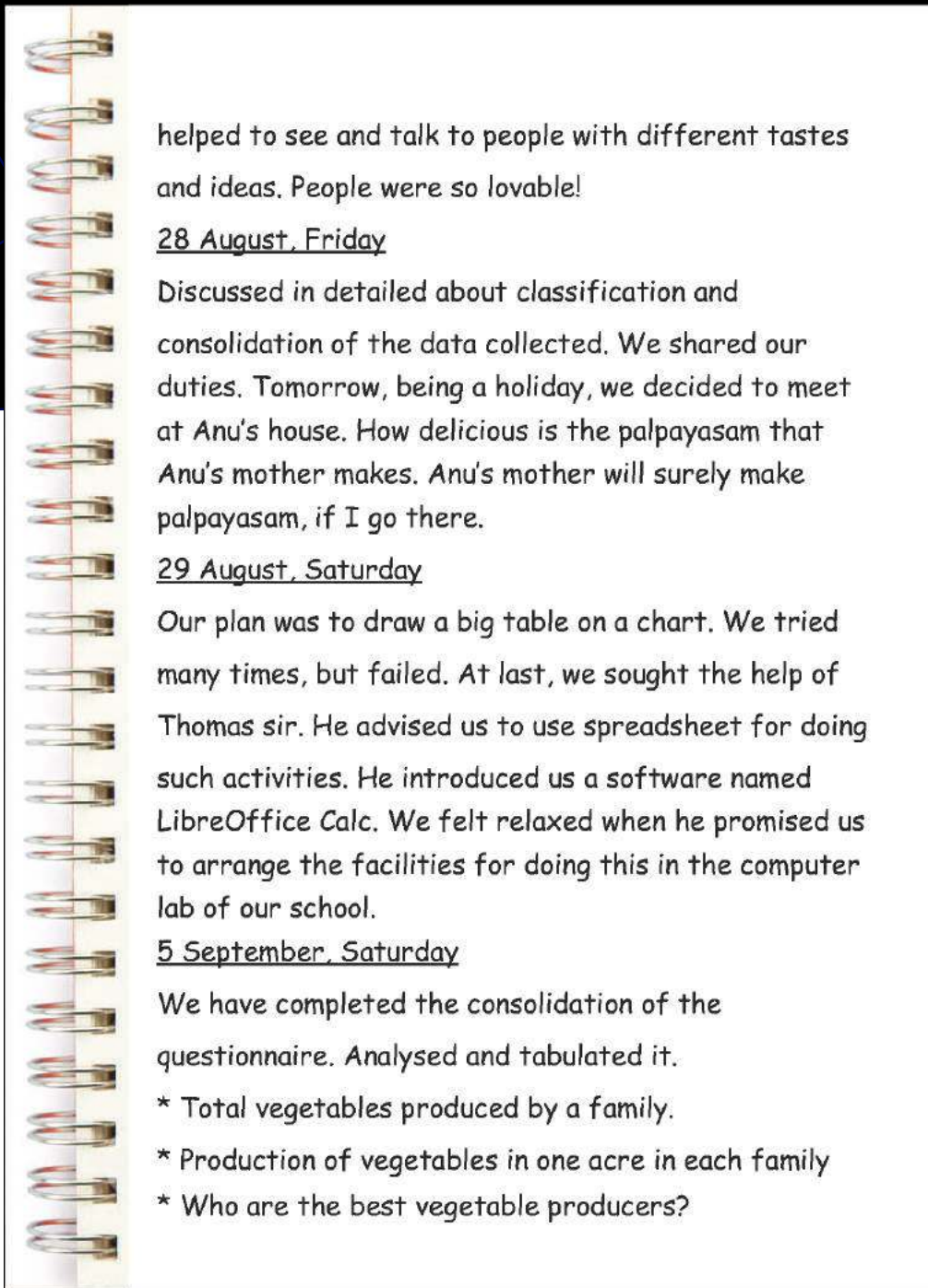

Pic.6.9 A page from the project diary

You have read the page from Amina's project diary, haven't you? Now, expand the table with the data she wants to collect.

.....

.....



Really a Spreadsheet...!

Try to reach the last row or column of the spreadsheet. Oh...! How many rows and columns? Press the 'Ctrl' Key and 'Down Arrow' Key together. Don't you see the last row? See the name of the last row. Then Press the 'Ctrl' Key and 'Right Arrow' Key together. Your mouse pointer will reach the last column. See the address of that cell. Spreadsheets contain lakhs of rows and thousands of columns. You can reach the first cell by pressing the 'Ctrl' key and 'HOME' Key together.

Functions in Calc

'Sum' is a function (program) in LibreOffice Calc. You can see a number of functions like this in LibreOffice Calc. You will familiarise more functions in the higher classes.

How can we find out the answers to the above questions from the table (Pic. 6.5) created in LibreOffice Calc? First, let's find out how much vegetables each family produced.

To find the sum,

- ◆ Select the cell in which you have to get the sum total of the quantity of vegetables produced by each family. Isn't the cell empty now?
- ◆ Click on the Σ 'Sum' tool in the toolbar (Pic.6.8).
- ◆ What do you see in the column (Pic.6.10) you selected for getting 'Sum'?

SI No	Spinach	Cucumber	Finger	Beans	Others	Total
4	29	67	43	22	77	=SUM(F4:J4)
5	22	12	8	13	10	
6	3	53	76	12	33	68

Pic. 6.10 Sum Function

"=", "SUM", and the address of the first and last cells of which you have to find the sum (parted by ":")? What do you mean by this? It means the cell should have the sum of the data in the cells from F4 to J4'.

- ◆ Now, press the Enter Key. You will get the sum of vegetables produced by one family.

How can we find out the sum of the vegetables produced by the other families?

- ◆ Select the cell in which you got the sum.
- ◆ Find the sum of all the other cells using the 'Fill Handle' on this cell.
- ◆ Double click on the "+" button instead of dragging below. What happens?

When we add serial numbers, number series is added in the nearby cells. But here, the formula for finding the sum is added instead. How can we find out itemwise sum of the vegetables produced? We have to find the sum of the data given in rows instead of that in columns. How can we find the production/acre of each family?

- ◆ We get the production/acre by dividing the total production by the measurement of land used.
- ◆ Let's write using the cell address as we have done to find the sum. Suppose the total production is entered in cell F7 and measurement of land in J7. Try to write the 'Function' including the cell addresses of them.
= /
- ◆ Enter this function in the related cell and press the Enter Key. You will get the production/acre.

You can see a lot of digits in certain cells. Select such cells and use tools like  (Pic 6.8). Identify the use of each tool and complete the table 6.2.

Do not Type the Cell Address, just Click!

Instead of typing in a function cell, you can use the following methods:

- ◆ Click on the function tool "=" (Pic.6.8) on the toolbar.
 - ◆ Click on the cell in which the total production is given. You can see the address of the cell, can't you?
 - ◆ Enter the symbol of division "/".
 - ◆ Click on the cell in which the measurement of land used is given.
 - ◆ Press the Enter Key. Don't you get the production/acre?
- Find the production/acre in all cells using 'Fill Handle' tool.

Activity 6.4 - Let's find out the Best Vegetable Producer

How can we find out the best vegetable producer from the table? The best vegetable producer will be the person who has produced the largest quantity per acre. It is difficult to find out one person from a long list of agriculturists. It will be easy, if we can arrange the list in descending order in accordance with the amount of production. Arrange the table in descending order using the steps given below. Pic. 6.11 may help you.

- ◆ Select the entire table.



Tool	Use
	
	

Table 6.2 Use of sorting tools

- ◆ Select 'Sort' from the Data menu.
- ◆ Select the column which is to be sorted in the 'Sort Key 1'. Here, it is production/acre column.
- ◆ Select from the option 'Ascending/Descending'.
- ◆ Click 'OK'.

Now, you can see the name of the best vegetable producer on the top of the table. Note down the first three best vegetable producers' names and the amount of vegetables they have produced. Don't forget to save the changes you have made in the file.

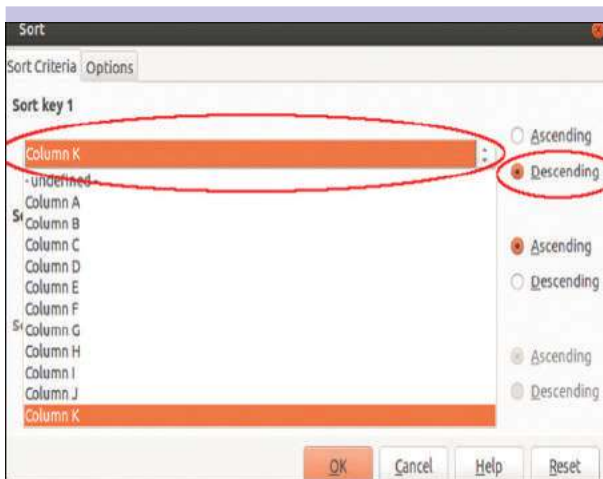

Pic. 6.11 Sorting

Activity 6.5 - Let's beautify the table

Pic. 6.12 shows the beautified tables prepared by Anu and Amina. See how the title 'Questionnaire Consolidation' is given.

What are the features of the title given here?

- ◆ This is the heading of the table.
- ◆ This is placed in the centre of the table in big letters.

Questionnaire Consolidation											
Sl No	House No	Total Land (In Acre)	Measure of Land Used (In Acre)	House Name	Quantity of Vegetables Produced (in Kg)						Production /Acre
					Spinach	Cucumber	Ladies Finger	Beans	Others	Total	
1	367	1	0.8	Shanibhavan	29	67	43	22	77	238	297.50
2	695	0.6	0.25	Chengala	22	12	8	13	10	65	260.00
3	276	2	1.1	Pathuthara	53	76	12	33	68	242	220.00
4	342	0.85	0.4	Snehtheeram	10	31	0	34	12	87	217.50
5	654	2.2	0.9	Sarang	22	45	35	54	29	185	205.56
6	345	2	1.5	Vallikalil House	35	89	30	67	74	295	196.67
7	134	5	2.5	Rahna Manzil	61	123	45	95	86	410	164.00
8	876	5.6	2.9	Manukkara	78	85	98	48	75	384	132.41
9	791	3.5	1.7	Vatakkeveedu	37	56	60	25	12	190	111.76
10	765	0.45	0.1	Saketham	1	5	2	0	2	10	100.00
Total		23.2	12.15		348	589	333	391	445	2106	173.33

Pic. 6.12 Formatted and beautified table

◆ It is coloured.

◆

In order to prepare a heading like this, we have to merge the cells in which we have to add the heading. To merge cells, first of all select the cells to be merged.



Then click Merge Tool from the Tool Bar (Pic.6.8).

Now, select the cells to be merged in the table. You have already learned to resize and colour the letters in LibreOffice Writer, haven't you? Prepare a catchy title for your table too.

Cells should be formatted for solving these problems. Do the following activities to format the cells. Pic.6.13 may help you.

- ◆ Select the cells to be formatted.
- ◆ Select 'Cells' in the 'Format Menu'.
- ◆ Select 'Alignment' from the window that opens.
- ◆ Check 'Wrap text automatically' (Pic.6.13).
- ◆ Select 'Text Orientation' and 'Text Alignment' and make necessary changes.
- ◆ Click OK.

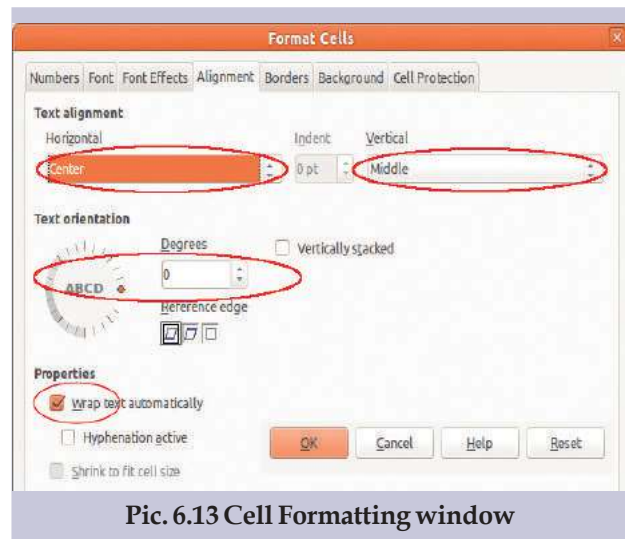

Pic. 6.13 Cell Formatting window

Heading of certain columns are not visible completely!!

If there was a border for each cell, it would have been more beautiful.

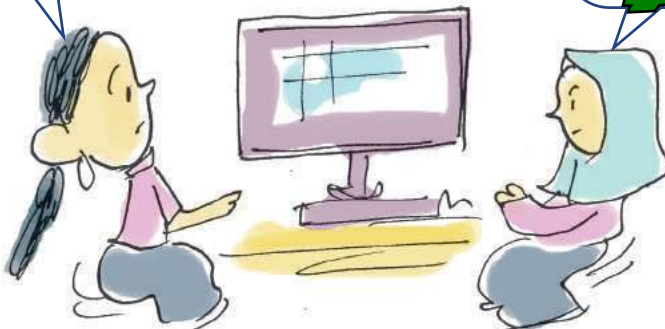

You might have noticed the border lines given to the cells in Pic. 6.12. How can we give border lines to the cells in the table we have prepared? Complete the steps in the process given below and try it in Calc. Pic. 6.14 may help you to do this activity.

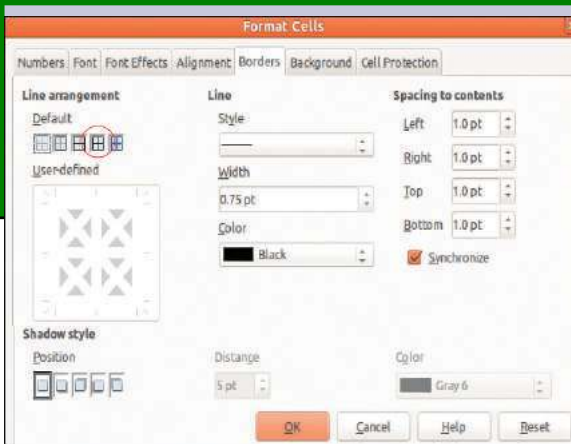

Pic. 6.14 Window to give border to cells

- ◆ Select the cells to which border is to be given.
- ◆ Select from Format menu.
- ◆ Select from the window opened.
- ◆ Click on 'Set Outer Border and All Inner Lines' from 'Line Arrangement'.
- ◆ Change Style, Width and Colour of the line, etc. if necessary.
- ◆ Click OK.

Now, you have given borders to all the selected cells. Don't forget to save the changes.

Activity 6.6 - Let's include a chart

The project work of Amina and Anu is in its last stage. They prepare to present their findings before an audience. They have to complete the project report which they are preparing in LibreOffice Writer. Then, they have to prepare a multimedia presentation using a presentation software.

Are the observations of Anu and Amina correct? Isn't it easier to communicate with the help of graphs and pictures than with big tables containing a lot of figures? There are options in LibreOffice Calc to create beautiful graphs representing the given data. You have already calculated the itemwise production of vegetables. How can we change them into a graph? Select the cells containing the data which is to be changed into the form of a graph (Pic.6.15).



Adjusting the Height of Rows and Width of Columns

We come across situations when we have to adjust the height of rows and the width of columns. Click on the column header in which the width is to be changed. Bring the mouse pointer to the nearby cell. You can see the mouse pointer changing into an arrow mark. Now, you can drag and adjust the size of the column. (Pic. 6.15). You can do this using the 'Row/Column' option in the Format Menu.

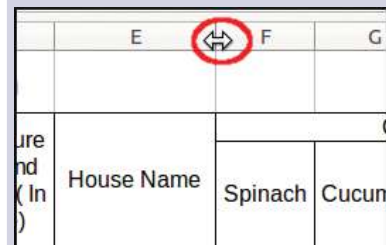

Pic.6.15 Adjusting the width of the column

How can we select two parts of a spreadsheet together, as shown in Pic.6.16? If you select the second part after selecting the first part, the part selected first will be deselected. Now, press the 'Ctrl. Key' and select the two parts. You can see that both the parts are selected together.

After selecting the cells, click on  tool in the toolbar (Pic 6.8). Do the following activities in the window that opens in the order given.

1. Select Chart Type - 'Column/Bar/Pie (Pic 6.17)
2. Click on 'Next' button in the windows, 'Data Type' and 'Data Series'.
3. Provide a heading for the graph and names for X and Y axis in Chart Elements (Pic.6.18).
4. Click on 'Finish' button.

Quantity of Vegetables Produced (in kg)					
	Spinach	Cucumber	Ladies Finger	Beans	Others
	29	67	43	22	77
	22	12	8	13	10
	53	76	12	33	68
	10	31	0	34	12
	22	45	35	54	29
	35	89	30	67	74
	61	123	45	95	86
	78	85	98	48	75
	37	56	60	25	12
	1	5	2	0	2
	348	589	333	391	445

Pic. 6.16 Two parts in Spreadsheet are selected together

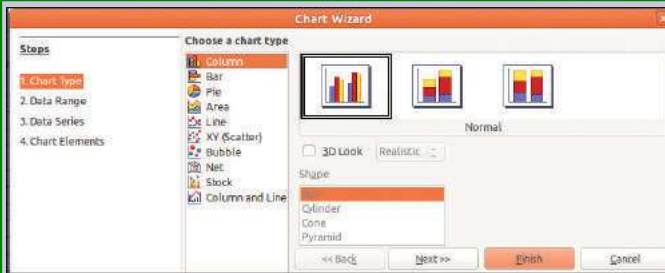

Pic.6.17 Chart Wizard - Chart Type window



Pic.6.18 Chart Wizard - Chart Element window



Let's Evaluate

1. Complete the table given below :

Name of column	Name of row	Cell address
J	19	
		AA44
B		B13
	123	P123

Data Analysis Made Easy

2. Prepare the calendar of January 2016 using the hints given below:

- ◆ Use Fill Handle Tool.
- ◆ January 1, 2016 is Friday.

3. The following table gives the population of five districts in Kerala, according to the Census 2011. Find out the total population using LibreOffice Calc.

Sl. No.	District	Male	Female	Total
1	Kasaragode	626617	675983	
2	Kannur	1184012	1341625	
3	Wayanad	401314	415244	
4	Kozhikode	1473028	1616515	
5	Malappuram	1961014	2124942	
Total				

4. The following picture shows the menu Manu got when he clicked on a tool in LibreOffice Calc. Study the picture and write down your observations.

	Spinach	Cucumber	Finger	Beans	Others	Total
1	29	67	43	22	77	=SUM(F4:J4)
2	22	12	8	13	10	

- 1)
- 2)
- 3)
- 4)

5. "Spreadsheet software makes academic projects easier." Substantiate your views.



Follow-up activities

1. Prepare a table in LibreOffice Calc of the height (in metres) and the weight (in kilograms) of the students in your class. Calculate the BMI (Body Mass Index) of all the students. Arrange the table as the student with high BMI comes first. Beautify the table.

(Hint: $BMI = \text{Weight in Kg} / \text{Height in Metre}^2$)

2. Collect the monthly expenditure on various items of ten families living near your school. Consolidate the data in LibreOffice Calc. Find out the total expenditure of each family and total expenditure on each item. Prepare a pie diagram showing the expenditure on each item. Beautify the table.



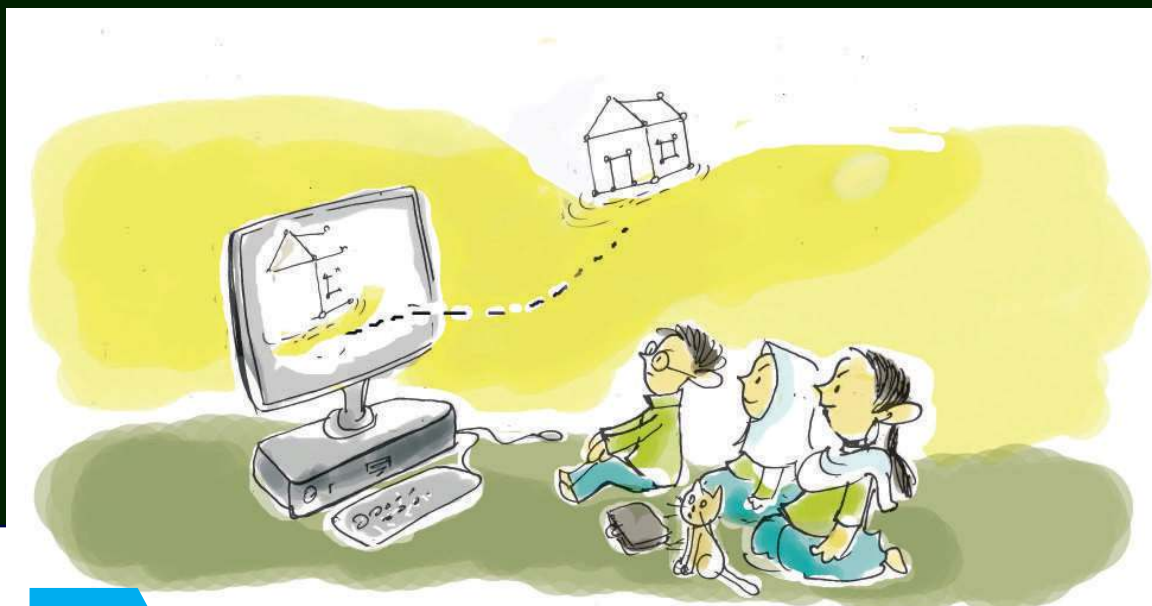

7 Laboratories in your Computer

By learning this unit, the learner will be able to:

- ◆ do experiments and record the results with the help of scientific simulations.
- ◆ find out the different states of substances with the help of PhET software.
- ◆ explore and write the possibilities of simulation in self learning.
- ◆ draw different geometrical shapes using the features of GeoGebra software.
- ◆ identify the features and draw angles between lines, using GeoGebra software.
- ◆ draw triangle and find out the measurements using GeoGebra.
- ◆ find out the facts behind the scientific names of elements and other features with the help of Kalzium software.
- ◆ compare the features of different elements and prepare write-ups using Kalzium.
- ◆ prepare models of molecules with the help of Gchemical software.
- ◆ compare the structure of different molecules and prepare notes using Gchemical.

The growth and development of science depend on experiments and observations. The basis of science is the lessons that the primitive man got from his surroundings and experiences. Each finding and realisation is the stepping stone to the next phase into the growth of science. In this digital age, we make use of computer technology to its maximum in every walk of life. Today, we have Virtual Labs which help even highly complicated experiments in the field of scientific research. Many softwares are also available today to make our science lessons interesting. Let's see some of them.

Particles of substances and temperature

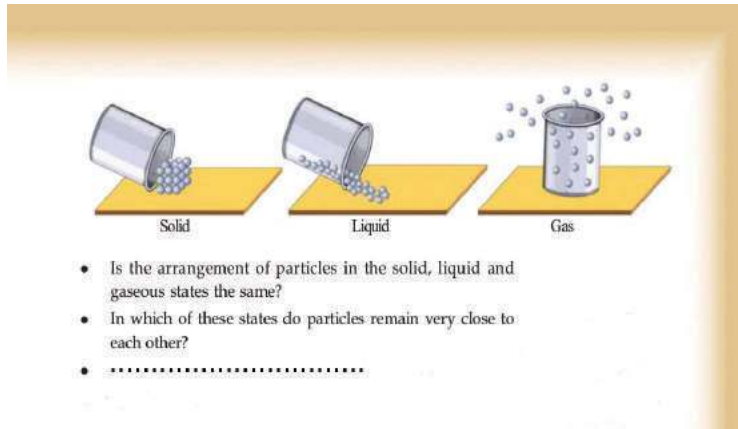

Have you ever thought of the elements with which our universe is made of? What are the different varieties of substances that we see around us? Substances have different shapes, features, colours, smell and tastes. Our universe got its wonderful shape and beauty from these substances.

The air we breathe, the water we drink, the materials we use to construct houses, etc. have different features. All these substances are made up of atoms. You have learned in your science classes about the arrangement of atoms in these substances. It is difficult to see and understand the features of atoms even with the help of a microscope. But nowadays there are Simulation softwares which help us to understand the atomic features of substances. PhET in Gnu/Linux is such

Laboratories in your Computer

a software. Let's do some activities using this software.

Activity 7.1 Let's change the temperature of a substance

Do you think that a change in the temperature of a substance causes a change in the nature of atoms in it? Let's observe this phenomena through PhET simulation.

PhET Simulation - Certain Hints

- ◆ Open 'PhET simulation' from 'School Resources' in your computer.
- ◆ Click on 'Play with Sims' to find out the activity in Physics to find out the nature of atom (States of Matter).
- ◆ Click on 'Simulation'.
- ◆ Find out the facilities in the main window of States of Matter simulations with the help of Pic.7.2 and do the experiments.
- ◆ Click on number '3' to select a substance.
- ◆ Choose a suitable unit of temperature ($^{\circ}\text{C}$ or 'K') from the place where number '4' is marked (Pic.7.2).

Let's change the temperature of a substance. The simulation shows us how this substance changes when the temperature is changed. For this, click on the button where '1' is marked in Pic.7.2. Then, the temperature can be increased or decreased using the arrow keys. When you reach the temperature needed for the experiment, we can fix it permanently by clicking the Esc button.

What did you understand from this simple



Pic. 7.1 PhET window

PhET is a collection of interactive simulations which helps us to teach and learn Science and Mathematics. It is prepared by the 'Open Educative Resources', a project of the University of Colorado Boulder in America. The project was started by the Nobel Prize Winner Carl Wieman in 2002. PhET is the abbreviation of Physics Education Technology. Though it started with simulations for Physics, it was later spread to other branches of science too.

PhET simulations are available online. PhET Online Simulation is available in the website 'phet.colorado.edu'.

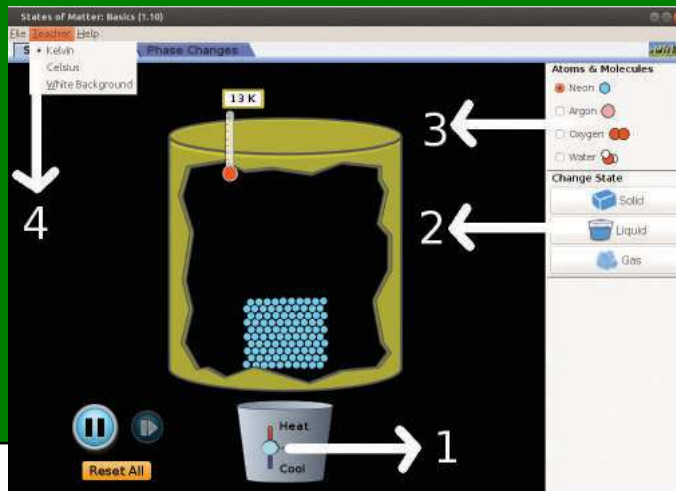

Pic. 7.2 PhET - States of matter window

1. To change the temperature
2. To change the state of substances
3. To select different substances
4. To change the unit of temperature ($^{\circ}\text{C} \rightarrow \text{K}$)

activity? In which state are the particles closely packed - solid, liquid or gas? What difference does it make in the nature of atoms, as the temperature changes? Observe and make a note about it.

Activity 7.2 Let's complete the table

Table (7.1) from your Science textbook is given below. Complete the table with the help of PhET software.



Simulation software

Experiments which cannot be carried out even in your school science lab can be done using software. Science simulations are imitations of scientific operations in the real world created in computers using software. Using this, we can closely watch and study about complicated and dangerous scientific phenomena, or those which happen in places we cannot reach. Most often these simulations are created just for the purpose of observation study rather than to get a copy of scientific facts. To observe how the same scientific phenomena happen in different situations, we can change the value of the elements which control that particular scientific phenomena. Such simulations are known as interactive simulations. Stellerium (study of the sky and the stars and K stars) is an example of a simulation software.

How does the nature of atoms change when they absorb heat?

- ◆ Energy of particles :
- ◆ Distance between the particles :
- ◆ Attraction between the particles :
- ◆ Movement of particles :

Table 7.1 Fill up with using PhET software

Activity 7.3 Let's complete the table using PhET software

Table 7.2 from your Science textbook is given below. Complete it with the help of PhET Software.

	When solid changes to liquid	When liquid changes to gas	When gas changes to liquid	When solid changes to gas
Movements of particles				
The distance between particles				
The attraction between particles				
Energy of particles				

Table 7.2 Complete the table using PhET software



Let's Evaluate

1. Find out the state of the particles of water molecule at 120°C with the help of PhET software and save a screenshot of it.
2. Display the solid state of Oxygen with the help of PhET and save a screenshot of it.
3. Display the state of water and Argon at 350K and save a screenshot of it. Compare the three states.
4. Observe the movements of particles in solid, liquid and gaseous states and prepare a note.



Follow up Activities

1. Take PhET Online Simulation Lab from the internet (phet.colorado.edu) and find out more activities from it.
2. Find out and activate other simulatins in PhET software related to the lessons in your Science textbook.

Geometrical constructions



Marks Hoven

GeoGebra is a software which helps the study of Mathematics. This software is available in different operating systems. We use GeoGebra 4 which works in GNU/Linux for doing different classroom activities. Marks Hoven, who was a teacher in the University of Salsburg, Austria developed GeoGebra in 2001 and it is still being modified. This is purely a Free Software. Michael Borchers, a school teacher is another person who played an important role in developing this software.

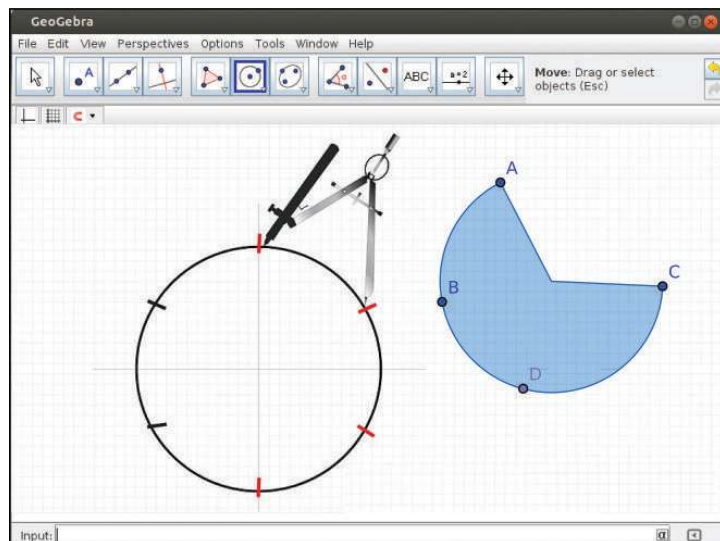

You have drawn many shapes and observed their features as part of learning geometrical constructions, haven't you? How many angles are there between two lines? There will be four angles between two intersecting lines. To examine whether there is any relation between these two angles, you have to make more geometrical constructions in your notebook and calculate their measurements to reach a conclusion. We can do these activities with the help of software in our computer.

Softwares like GeoGebra, Drawing Geometry, etc. help us to draw geometrical constructions and to see the changes in their measurements. It is included in the education package in IT@ school GNU/Linux.

Laboratories in your Computer

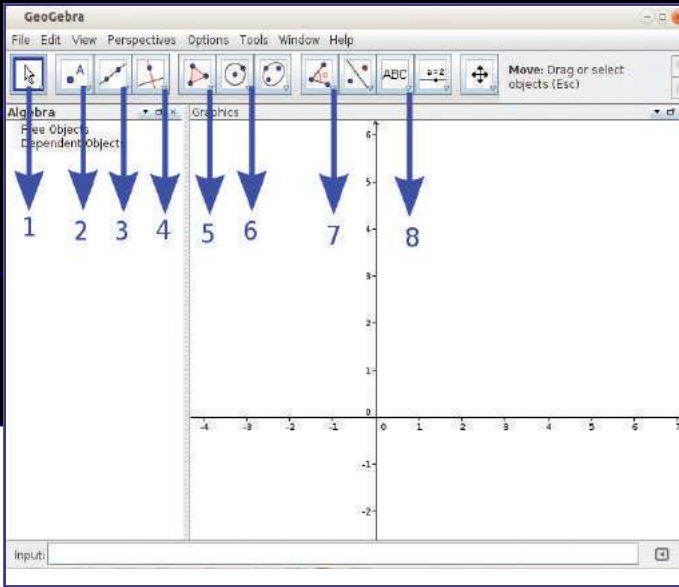

Pic. 7.3 The main window of GeoGebra

Open the main window of GeoGebra and observe various facilities available in it. (Pic 7.3)

There are many tools in GeoGebra which help to construct geometrical shapes. These tools are arranged in groups. For example, tools for drawing points are included in group '2'.

1. Tool to move
2. Tools related to points
3. Tools related to lines
4. Tools to draw verticals and parallels
5. Tools to draw polygons
6. Tools to draw circles
7. Tools related to angles and measurements
8. Tools to type texts

Table 7.3 Use of different tools in GeoGebra

Activity 7.4 Let's draw and measure angles between lines

Let's see how we can draw and measure an angle between two lines, with the help of GeoGebra software. Select the tool 'Segment Between Two Lines' from the third group of tools and click on two points of the surface to draw the line AB. Like this draw the line CD. (Pic 7.4)

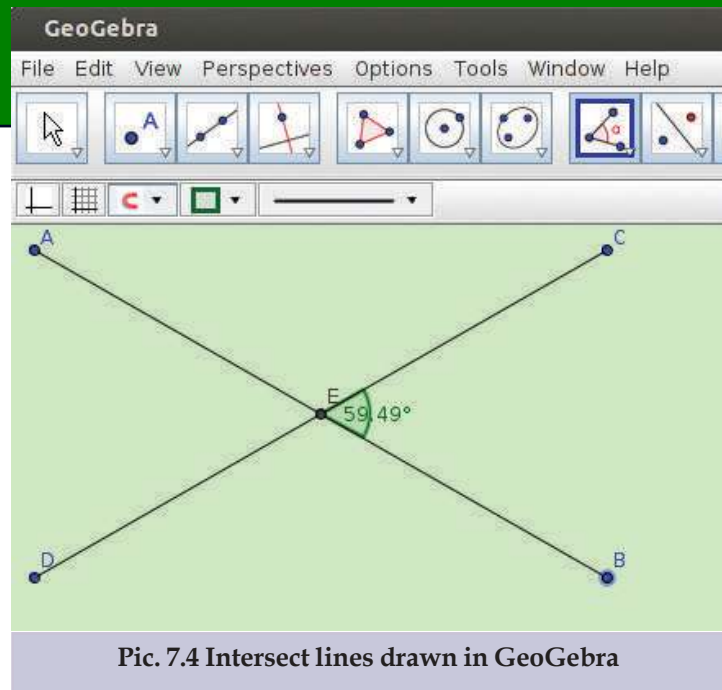

We have to draw the joining point to mark the angles between two lines. Now, select 'Intersect Two Objects' tool and click on the two lines.

Select 'Angle' tool. Click on and rotate clockwise on the points which decide the angle. Click on and rotate anticlockwise and find out which angle measurement is received.

We can change the position of Vertex in the picture using the 'Move' tool. Click on the 'End points' of the lines and drag it, and observe how the measurements of angles change.

Activity 7.5 Let's draw a triangle

How do you draw triangles in your notebook? Usually we draw triangles by joining three lines which are not in

Laboratories in your Computer

the same line, with the help of a ruler and a pencil. In the same way, you can draw triangles using GeoGebra. Besides this, you can also draw triangles and polygons easily, using the polygon tools (Group 5 in Pic. 7.3).

Open GeoGebra window and choose 'Polygon' tool. Click on three points which are not in the same direction and finish clicking on the point you started with. What are the measurements of the triangle you have drawn? Choose 'Distance or Length' tool (Group 7 in Pic. 7.3) from the angles and measurements tools and click on each side of the triangle. See the measurement you get when you click inside the triangle. Observe what happens when you click inside the triangle using the 'Angle tool' and the 'Area Tool' and complete table 7.4.

Activity 7.6 Let's prepare a heading

How can we give a heading to the picture drawn in GeoGebra? Select 'Insert Text' (group 8 in Pic 7.3) to type text and then click on the canvas. Type the text above the 'Edit' menu in the window opened and click on the 'OK' button. To make the heading attractive you can use the facilities available in Properties window.

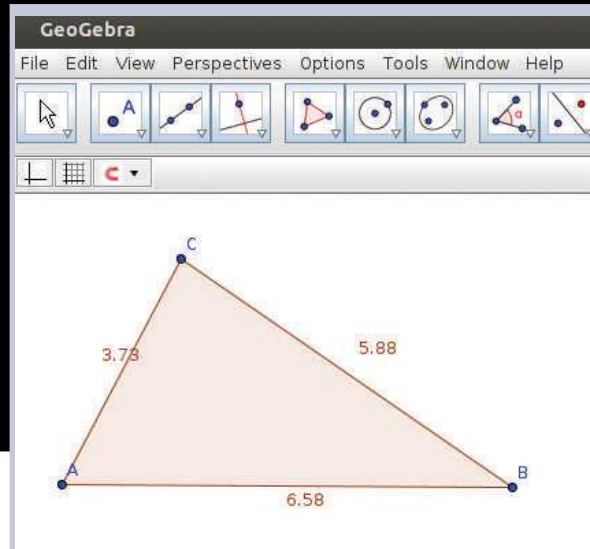

Pic. 7.5 Triangle drawn in GeoGebra

Let's change the colour and shape of the picture

Place the mouse at one point of the picture drawn and click the right button. Select 'Object Properties' from the menu opened. You will get a window. There are facilities in this window to change the colour and shape of lines.

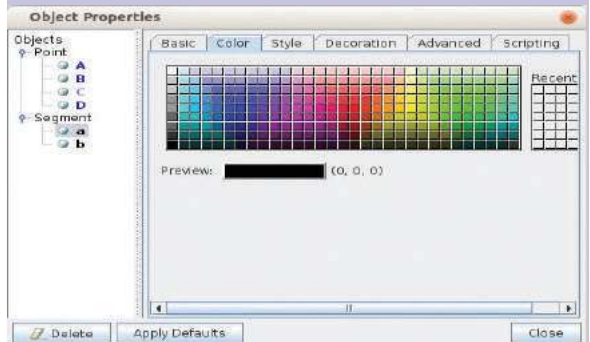

Pic. 7.6 Object properties window

Tools for measurement

Method of using tools	Result
Click on the lines using 'Distance or Length' tool	Got the length of lines
Click inside the triangle using 'Distance or Length' tool	
Click and drag clockwise in the vertex of the cones using 'Angle' tool	
Click inside the triangle using 'Angle' tool	
Click inside the triangle using 'Area' tool	

Table 7.4 Tools for measurement

Let's save

To save your constructions prepared in GeoGebra use 'save' in File menu. Give the extension 'ggb' while saving it.

You can also use 'Regular Polygon' tools to draw triangles and polygons. When you mark any two points in the canvas using this tool, there appears a window demanding the numbers of sides of the polygon. When you give the numbers of the polygon in this window and click 'OK', a polygon will appear. Observe the features of the given polygon and save it in your folder.

Activity 7.7 Let's draw circles

In GeoGebra, there are many tools used to draw circles. (Group 6 in Pic.7.3)

Let's see them.

1. A circle having one point as its centre and passes through another point.
2. A circle passing through three points.
3. A circle with one point as its centre and another as the radius.

To draw a circle with one point as its centre and passing through another point, select 'Circle with Center through Point' tool and click on two different points. Like this, use the other available tools and practise drawing circles.

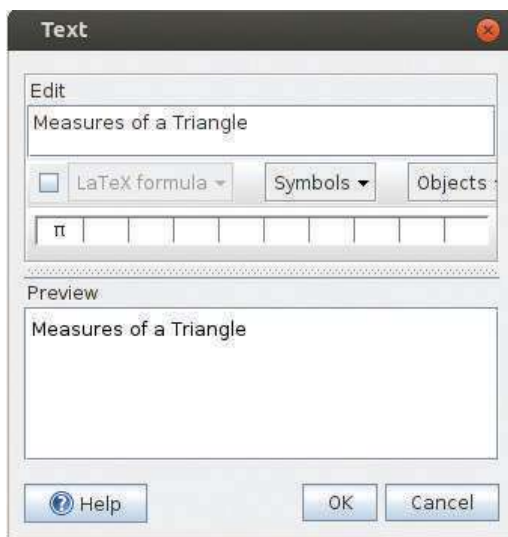

Pic. 7.7 Text Edit Window

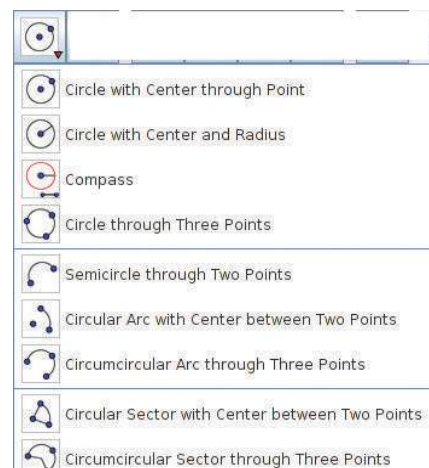

Pic. 7.8 Sixth group tools in GeoGebra



Let's Evaluate

1. Draw two horizontal lines. Draw a vertical line across them and measure all the angles formed.
2. Draw a Regular Polygon with five sides in GeoGebra and give blue colour to it. Name it as 'PENTAGON'.
3. Mark three points 'A, B, C' and draw a circle passing through these points. Join A, B, C and draw a triangle. Give different colours to the circle and triangle.
4. Mark a point 'P' and draw a circle with 3 cm radius and 'P' as its centre. Measure the length of the radius using 'Distance' tool.



Follow-up activities

1. Draw a pattern as shown in Pic. 7.9 with the help of Regular Polygon Tool. (Hints: Midpoint tool helps us to find out the midpoint of each side of a polygon).
2. Draw a triangle using Polygon tool and find out the circumference and surface area of the triangle.
3. Draw the picture on Page 58 of your Mathematics textbook in GeoGebra (Pic. 7.10)

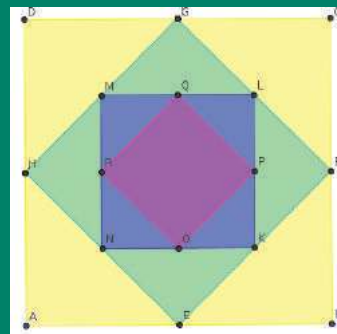

Pic. 7.9

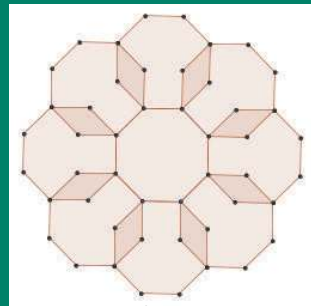

Pic. 7.10

Hints: Draw a polygon with 8 sides using 'Regular Polygon' tool. Click on each sides in anticlockwise and draw another polygon with eight sides on each side.

4. Draw Pic. 7.11 using the small line tool. Measure the outer angles, table them and find out their sum. Repeat your observation with different number of sides.

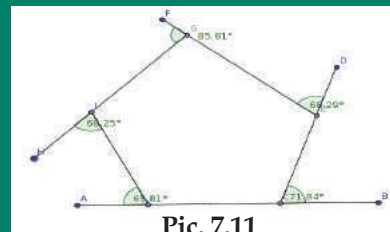

Pic. 7.11

Digital Periodic Table



You have already identified the features of particles in different states of substances, with the help of PhEt software. All substances on the earth are made of different elements. Elements can be classified based on their features. Periodic Table is a table in which elements are classified in this way. See the periodic table given in your Science Textbook. How many features of elements can you trace out from this table?

- ◆ Atomic Number
- ◆ Symbol
- ◆ Scientific Name

What will you do if you want to know more about elements? More information can be gathered from the internet or from books. There are many softwares which can provide us with the information scattered in many places. Most of them are interactive softwares which help us to do many experiments and arrange the elements in different ways.

Kalzium available in IT@SCHOOL GNU/ Linux is an interactive periodic table which provides facilities to study and compare elements. (Pic. 7.12)

Let's open the Kalzium software and see the facilities available in it. In order to learn more about elements, they are arranged in different ways in periodic tables. Select these tables from the menu marked in red Pic.7.12. Among these tables, which one is given in your textbook?

Activity 7.8 Let's find out the features of elements

Open Kalzium software and click on each element. Facilities are available to know the different features of

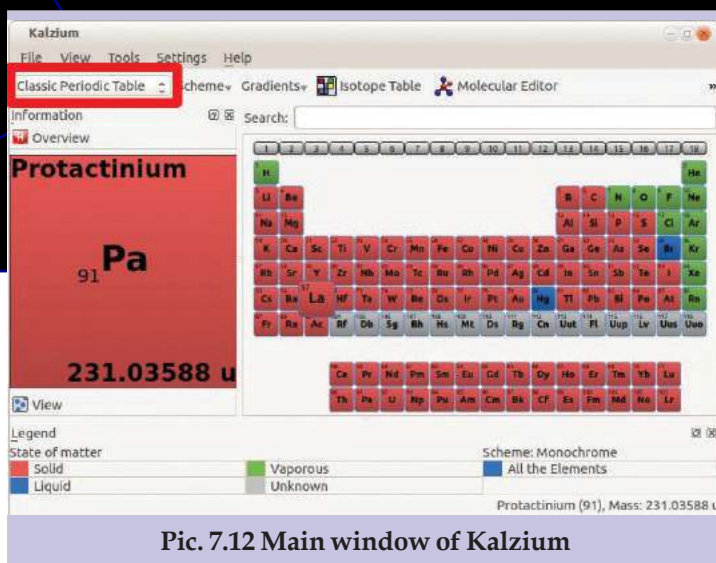

Pic. 7.12 Main window of Kalzium

the element you have selected. For example, let's click on Aluminium (Al) in the periodic table. What are the details that appear? Observe the details of Aluminium by clicking the tabs on the left side one by one. See the details of Gold (Au), Iron (Fe), and Zinc (Zn) with the help of Kalzium software and prepare a table as shown in Pic. 7.6.

Activity 7.9 How elements got their names

In earlier times, the elements were named after places, countries, names of scientists and planets.

The details about elements are given in Kalzium software. Select an element and click on the Miscellaneous tab on the left side of the window. You can see the name of the person who discovered the element, the year in which it was discovered and why it is named so. The details of Zinc (Zn) are given in Pic. 7.14.

Complete Table 7.7 with the help of Kalzium software.

Periodic Table

Periodic, Periodic Table of Elements etc. are other softwares, like Kalzium that provide details of periodic tables. These softwares include a lot of information about each element.





Who discovered Gold?



Pic. 7.13 Kalzium - Data Over View Window

Element	Aluminium
Symbol	Al
Melting Point	1808 K
Boiling Point	3023 K
Atomic Mass	55.845 u

Table 7.6 Features of the element - Aluminium

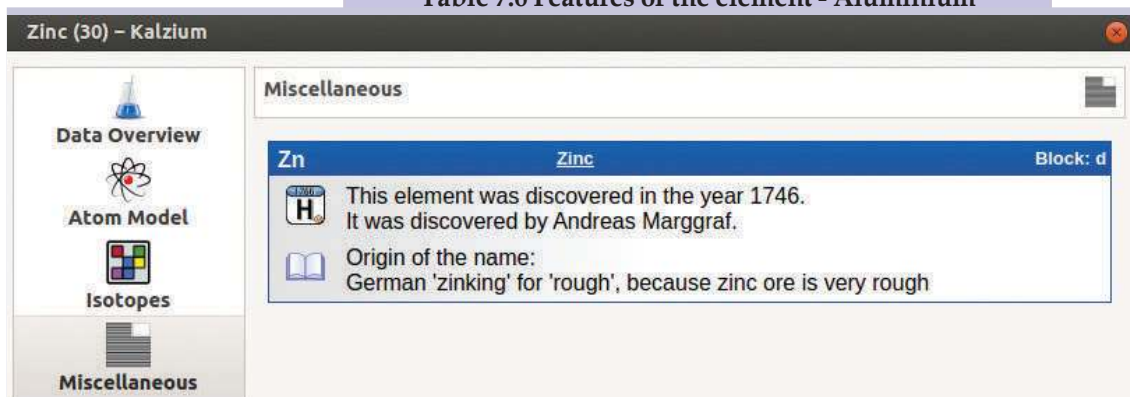

Pic.7.14 Kalzium - Miscellaneous Window

Element	Symbols	Basis of name	Person who discovered	Year of discovery
Americium	Am			
Francium	Fr			
Rubidium	Rb			
Copper	Cu			
Titanium	Ti			
Chlorine	Cl			

Table 7.7 Details of elements



Let's Evaluate

1. Prepare the model of Chlorine atom using Kalzium software. Take a screenshot and save it.
2. Symbols are used to represent elements. English letters are used as symbols. Complete Table 7.8 with the help of Kalzium software.

Element	Scientific name	Symbol
Silver		
Hydrogen		
Tin		
Antimony		

Table 7.8



Follow-up activities

1. Find out the other softwares in IT@School GNU/Linux related to periodic table of elements. Use them to identify their uses.
2. Find out the elements with the help of Kalzium software and tabulate them chronologically.

Models of atoms

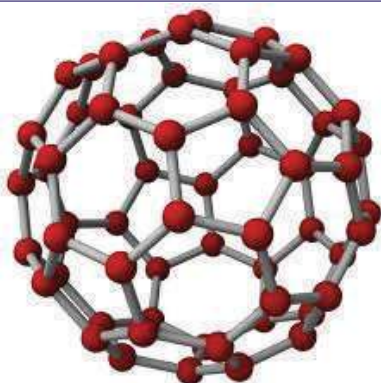

Water (H_2O) is a compound familiar to us. Water is a combination of Hydrogen and Oxygen atoms. Molecules are made of minute atoms. Molecules cannot be seen

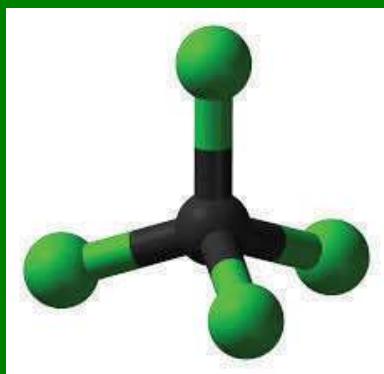

Pic. 7.15 Model of Methane molecule

with our naked eyes. Have you ever thought about them? Pic. 7.15 shows the model of a molecule of Methane (CH_4) which is contained in bio-gas.

As part of your classroom activities in Basic Science, you might have made models of molecules using the stick of coconut leaves and pearls. But with the help of certain softwares, we can make models of molecules easily. Chemical, the software available in IT@ School GNU/Linux helps us to make models of molecules and observe them in different ways. Open 'Gchemical' and observe the tools in it.

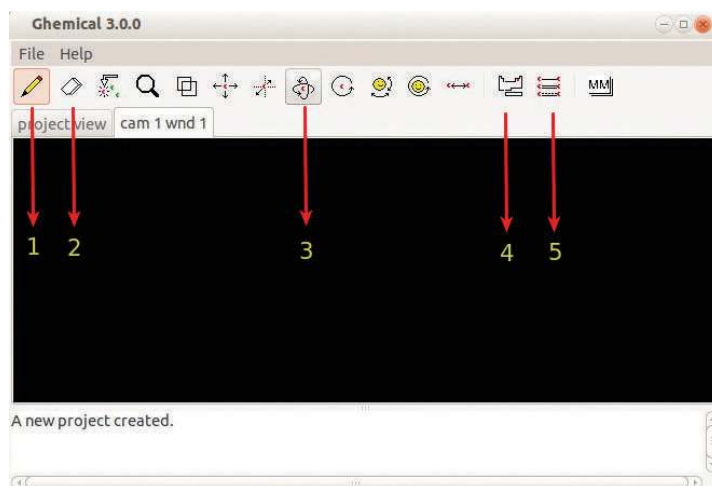

Pic. 7.16 Gchemical Window





Tool No. (Pic. 7.16)	Tool Icon	Use
1	 Draw	To draw
2	 Erase	To erase something
3	 Orbit XY	To turn the models three dimensionally
4	 Set the current element	To include atoms of elements
5	 Set the current bond	To select the chemical bond

Table 7.9 Tool icons and their uses

Activity 7.10 Let's make a model of molecule of water

Let's make a model of the molecule of water using Chemical software. You know that a molecule of water contains two Hydrogen atoms and one Oxygen atom.

Laboratories in your Computer

Let's see how we can make a model of a water molecule using Chemical software.

- ◆ Open the Chemical software.
- ◆ Click on the tool which is used to include atoms and select Hydrogen atom.
- ◆ Click on the canvas using Draw tool and include two Hydrogen atoms. Include Oxygen atom in the same way.

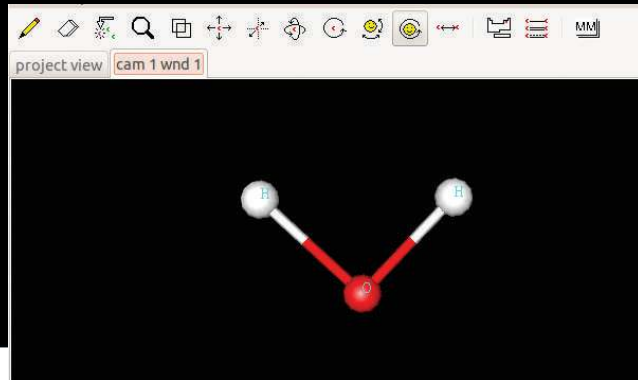

Pic. 7.17

Model of an molecule created using Chemical

- ◆ Click on the right button of the mouse on the canvas. Click on Render, Label Mode and Element correspondingly and show the name of the element.
- ◆ Select 'Chemical bond' to combine atoms.
- ◆ Drag from one atom to another using Draw tool.
- ◆ Click on the right button of the mouse on the canvas and click on Compute, Geometry Optimization correspondingly to arrange the molecules.
- ◆ Select 'Orbit XY' tool to rotate the model of molecule.
- ◆ Rotate the molecule to various directions using the mouse and observe it.



Let's Evaluate

1. Prepare a model of Ammonia (NH_3) molecule and present it.
2. Make a model of Carbon dioxide (CO_2) molecule and save a screenshot of it.



Follow-up activities

1. Which are the software available in IT@ School GNU/Linux to make the models of molecules? Work using these softwares.
2. Collect models of different molecules from the internet.

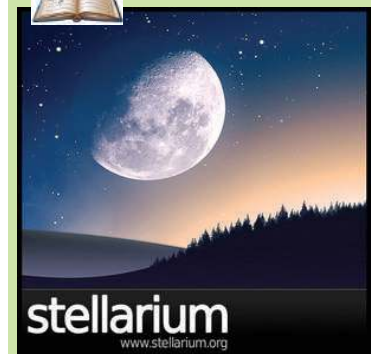

Stellarium is a simulation software providing simulate different sights of the sky. We can the sky as on any day or any time in our computer with the help of this software. This is a very useful software for sky watchers. We can find out the constellations, shapes, their names and the distance between them. There are details of more than 6,00,000 stars in this software.



8

Attractive Presentation

By learning this unit, the learner will be able to:

- ◆ recognise and write about the scope of multimedia presentation software.
- ◆ prepare a presentation storyboard.
- ◆ type content in a presentation software.
- ◆ save the presentation file in the folder after improving the presentation using various formatting techniques.
- ◆ insert a picture in the presentation and adjust its dimension as required.
- ◆ move characters and slides using animation techniques.
- ◆ present findings effectively with the help of a presentation software.

Attractive Presentation



"Do you know me? I'm an overhead projector. In earlier days, images and texts were presented before an audience using me. But after the arrival of computers, my position is in the attic of the school building. I'm not worried about it. Because I was replaced by a better one".

Have you read the monologue of an overhead projector? Overhead projector was an important equipment we used earlier for presentation. Using this projector, we could present images and texts prepared in transparent sheets. We used to project the images and texts on screens or walls using light rays. Haven't you seen the slot for keeping the sheet and the mirror for reflection in the above picture? It was major limitation of the overhead projector that motion pictures and certain colours could not be projected. The development of technology eliminated the need of overhead projector. Today, we can effectively present our ideas before others using pictures and motion pictures with the help of the computer.

Did you understand what Anu and Amina were discussing? They were discussing how they can effectively present the findings of their project. You already know that they were doing a project based on the lesson **Retrive Fields** in their Basic Science textbook.

Can we help Anu and Amina? What details are to be presented before the audience?

- ◆ Information related to project such as methodology, limitations and scope of the study etc.
- ◆ Findings and conclusions.
- ◆ Pictures and other data collected as part of the project.



- ◆ Audio and video clips of project activities, interviews, discussions etc.
- ◆ Tables, charts, graphs.
- ◆ Relevant areas in the project report.
- ◆
- ◆
- ◆

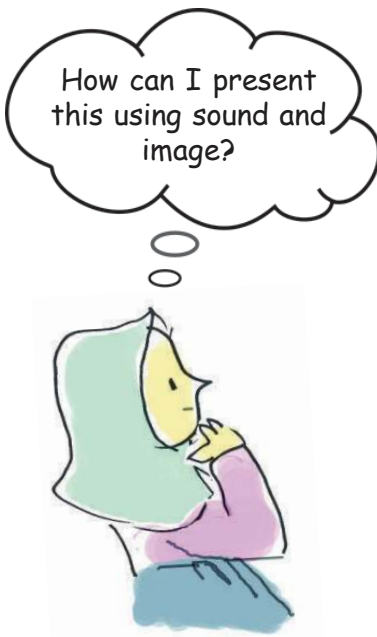

These details are now stored in computer and CD, aren't they? These are to be presented before the audience at the right time with clarity. Imagine that we are using an overhead projector for this. How many sheets will be required for preparing these pictures and texts? But now, these can be done easily using computers. The presentation with sound effect and images is possible using the multimedia presentation facility available in computers. There are so many software to help this. These are known as presentation softwares. The following are some popular presentation softwares. (Table 8.1)

Software	Developed by
LibreOffice Impress	The document foundation
Apache Open office Impress	Apache Software foundation
Kaligra Stage	KDE
Key note	Apple Inc.
Microsoft Power Point	Microsoft

Table 8.1 Different presentation softwares and developers.

Multimedia presentation is a slide show. What is slide? It is similar to the transparent sheet used in overhead projector. Presentation slide is a slide prepared in one page that contains information which appears at a time. Instead of slides prepared on sheets by drawing and writing, we use the computer technology for preparing slides. That's all.

What details are to be included in the presentation prepared by Anu and Amina? Based on the hints and points, prepare a note after discussion.

Attractive Presentation

- ◆ Texts, pictures, sounds etc. that are to be included in each slide.
- ◆ The background colour of each slide.
- ◆ The order and manner in which the slides are displayed.
- ◆

Complete your storyboard by observing the model of presentation storyboard given overleaf. You can improve your storyboard while preparing the presentation. Now, let's try to prepare a presentation on the basis the completed storyboard. For this we have to use the LibreOffice Impress software.

Presentation Storyboard

Storyboard is a term we hear in connection with filmmaking, animation etc. Before the shooting of a film so many preparations are needed. First, a story for the film is to be identified. Then, a script will be formulated from the story. Details such as camera position, dialogue of characters, movements, how and where each scene is to be displayed etc. are to be decided well in advance before the shooting begins. The next stage is preparing notes which include minute details that are not there in the script. These notes are known as storyboard. Storyboard can be prepared by writing or drawing. The details of each and every scene are available in the storyboard. In the same way, before a multimedia presentation is prepared, the details about how and where the text, table, picture, sound, video etc. are to be displayed should be decided in advance. The outline prepared in this way before making a presentation is called presentation storyboard. While a film storyboard contains the details which are to appear in each scene, a presentation storyboard contains the details to be included in each slide. It should be a note which contains all in details about the colour, type, form, size of the font, background colour, movement of letters, how and where pictures are to appear etc. It should also include all the changes to be made in a multimedia presentation.



LibreOffice

LibreOffice is a package which includes softwares like Word processor which is used to prepare letters, notices etc.; Spreadsheet which is used to analyse information; Presentation software used for presentation; Base used to handle data; Draw used to handle pictures etc. LibreOffice editions are now available for all important operating systems. This is developed by The Document Foundation. The main aim of LibreOffice is to create a non commercial office package supported by ODF (Open Document Format). The name LibreOffice is created by joining the word *libre* which means freedom and the word *office*.

Model Storyboard	
Slide: 1 Subject- Land utilisation and Vegetable cultivation <div style="border: 1px solid black; border-radius: 15px; padding: 5px; text-align: center;"> <i>Collage of various vegetables</i> </div>	Font size : 44 Colour : Pink Background : Sky blue Animation : Fade in Slide transition :
Slide : 2 Objectives of the Study 1. To find out the area of available land. 2.To find out the area of land used for agriculture. 3. 4.	Font size : (Study objectives : 44) Others : 32 Colour : Red Background colour : Light Yellow Animation : Fade in Slide Transition:
Slide : 3 Methodology 1. 2. <div style="border: 1px solid black; border-radius: 15px; padding: 5px; text-align: center;"> <i>Cartoon by a student</i> </div>	Font size (Method of Study : 44) Others : 32 Colour : Red Background colour : Light Yellow Animation : Fade Slide Transition :

Activity 8.1 - Typing Content

To type content, open LibreOffice window. Then try to do the activities given below.

1. In the window opened, type the required content by clicking the textboxes (Pic.8.1) named Click to add Title, Click to add Text, etc.
2. Insert next slide. As seen in Pic.8.2, by clicking 'Slide' in insert menu a new slide can be included. Don't forget to select the required layout while inserting the new

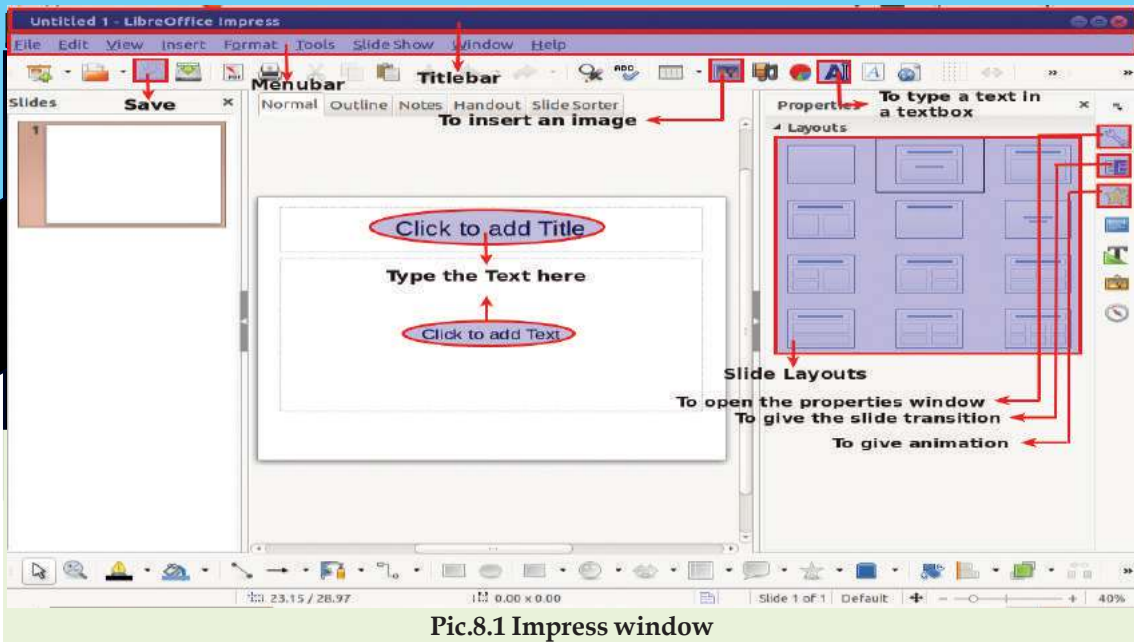

Pic.8.1 Impress window

slide. Textbox can be created by clicking the **A** icon seen at the top of the window.

3. Select the appropriate layout from the slide layout (Pic.8.1) region.

The first stage of making a presentation is typing the prepared content in the storyboard as different slides. Then, save the presentation in the Docs sub folder in your folder.

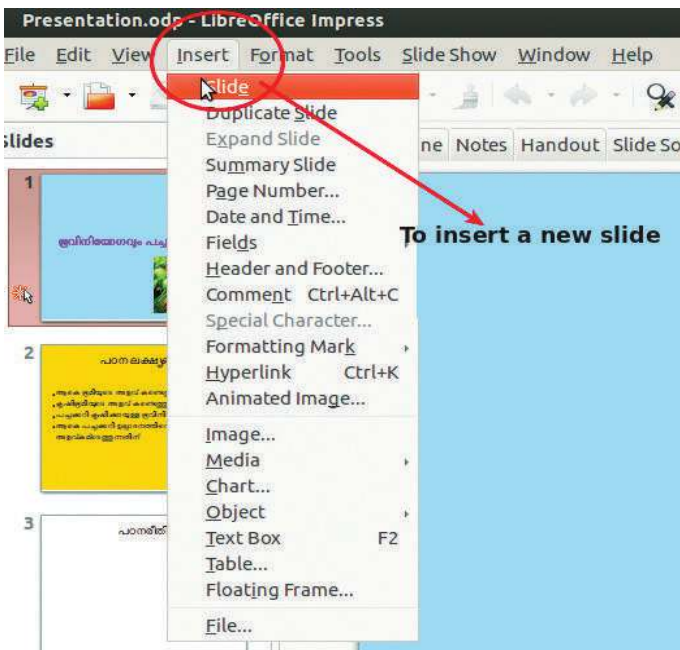

Pic.8.2 Inserting new slide



Slide layout is the model of pre-designed slides in a presentation software.

Activity 8.2 - Beautifying the Presentation

The next stage is to beautify the presentation. This process of beautification of the presentation can be named formatting. You have studied the techniques for beautifying characters and paragraphs in the first unit, **When Letters Reaches the Computer**. In a presentation, the characters in each box should be selected and beautified in contrast to Word processor.

Giving Background Colour

For giving background colour to a slide, try to follow the steps given below:

- ◆ Click on 'Page' in Format menu.
- ◆ Select the Heading from Background in the Page Setup window (Pic.8.3).
- ◆ Click on Colour at the Fill region in the window that appears.
- ◆ Select appropriate colour and click OK button.
- ◆ We can give background colour to the slide as we wish by clicking required location in the dialogue box that appears.

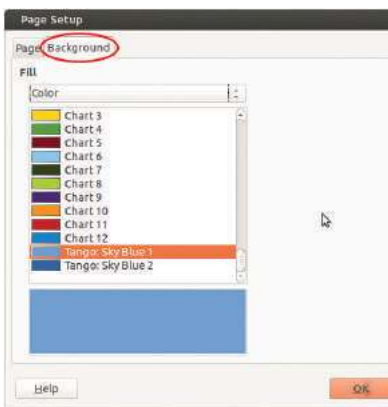

Pic.8.3 Page Setup window

Activity 8.3 - Inserting a Picture

We know that it is very helpful for communication if we present ideas along with pictures. To insert a picture in the presentation, try to do the activities given below.

A picture that we intend to be included can be inserted either by clicking on  icon in the presentation window (Pic.8.1) or by clicking **Insert → Image**.



Pic.8.4 Page Setting window

The inserted picture can be modified in a suitable manner for the presentation. For this, click on the picture. Drag by holding the mouse on the small squares that appear at the vertex of the picture. If the size does not change as intended, drag the mouse by pressing the Shift key.

Attractive Presentation

Activity 8.4 - Watching the presentation

Now the presentation is prepared and is saved in the folder. Let's present it before an audience. Try to start the slide show by clicking 'Start from First Slide' in the Slide Show menu (Pic 8.5). Don't the slides appear one after the other? Is the computer monitor visible to all the viewers? Don't you require a projector to enlarge the presentation? Connect the computer to a projector with the help of your teacher.

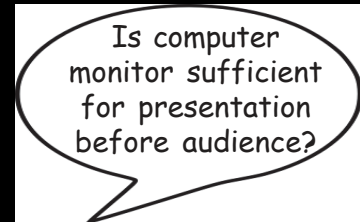

Slide show can be activated by pressing the F5 key on the top row of the keyboard.

Didn't you watch the slide show? How was it? Did you feel that it has to be improved? What is to be done to make the presentation more effective? Note down.



- ◆ The texts, images etc. should appear in each slide as desired by the presenter.
- ◆ The slides should appear in an attractive manner.
- ◆
- ◆



Projectors



Projector is the equipment which projects images on a surface or screen with the help of light rays. Normally, projectors reflect images with the help of light that passes through a lens in it. But now projectors are available which directly projects pictures with the help of laser.

Multimedia projectors are in use more nowadays. Slide projector as well as the overhead projector specified earlier were its predecessors. The slide projector which was in use from 1950 to around 2000 became completely obsolete after the introduction of digital projector. They are known as LCD projector and DLP projector based on the technology used such as LCD (Liquid Crystal Display) and DLP (Digital Light Processing) respectively. Among these, LED projectors use LED (Light Emitting Diode) technology for the source of light. Movie projectors are used in cinema theatres.

For this, let's get familiar with more techniques in the presentation software.

Activity 8.5 - Animating characters

The technique of animation can be used to give motion to the characters in a presentation. For this, follow the given instructions.

- ◆ Select the sentence/picture to be animated.
- ◆ Open the Custom Animation window by clicking on  icon in the side bar (Pic. 8.6).
- ◆ Give appropriate animation by clicking on  button in the window that appears.

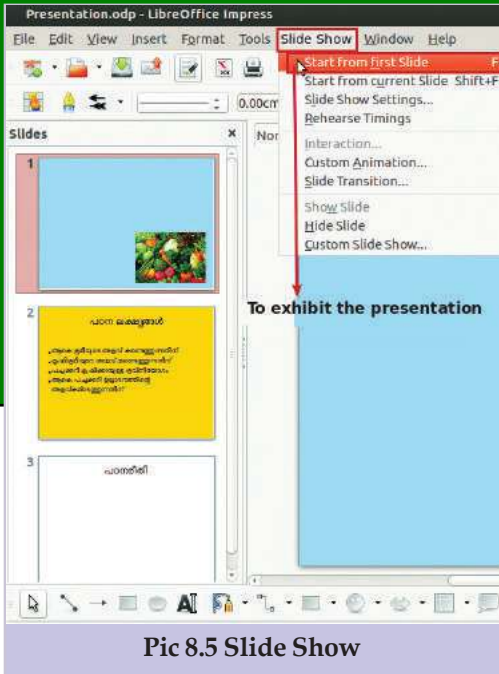

Pic 8.5 Slide Show

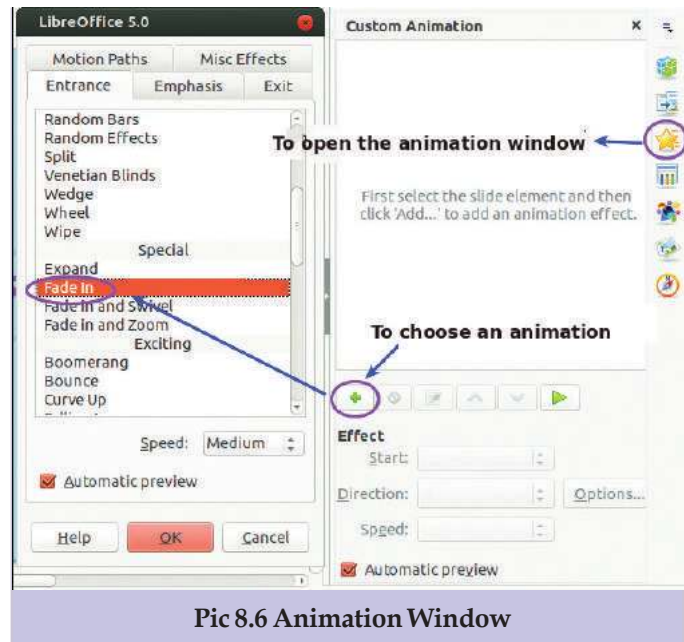

Pic 8.6 Animation Window

Activity 8.6 - Animating slides

The manner in which slides appear during the slide show makes the presentation attractive and catchy. We can arrange the manner in which slides should appear during the presentation. For this follow the instructions given below.

- ◆ Click on Slide Transition in the Slide Show menu.

Attractive Presentation

- ◆ Select the appropriate slide transition from the window that appears on the sidebar (Pic.8.7).

This window also helps you to determine whether the slide should appear on mouse click or automatically, during the presentation. Hope you will make necessary changes in the presentation after viewing it using slide show.



Let's Evaluate

- As different from a Word processor, which of the following characteristic did you find in a Presentation software?
 - Characters can be given colour.
 - Page can be given colour.
 - Picture can be inserted.
 - Animation can be given.
- Storyboard is prepared while making a multimedia presentation _____
 - To decide the content of a slide in advance.
 - To save the presentation.
 - To create textbox.
 - To make the projector working.
- Animation is given to a presentation _____
 - To show the slides in an attractive manner.
 - To give motion to characters and images.
 - To type the content.
 - To give colour to characters.
- Slide Transition in a presentation is
 - To show the inserted picture in a slide as the presenter likes.

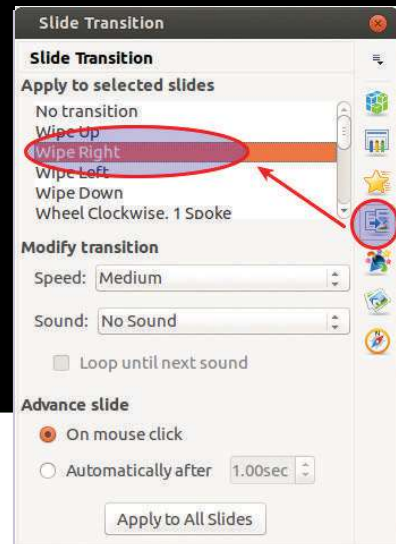

Pic 8.7
Slide Transition window

- b) To give a background colour.
- c) To decide the order of appearance of slides.
- d) To type the content.



Follow-up activities

1. Prepare a presentation in connection with the project **Soil and Human Intervention** in your Social Science textbook.
2. Prepare a presentation for an awareness class in connection with the World AIDS Day.
3. Prepare a multimedia presentation to describe the milestones in the history of Cell Biology.
4. “ Journey gives not merely the experience of sight but a plenty of other things to us.” - Prepare a presentation based on the activities given in the lesson ‘**Vazhiyathra**’ in the Kerala Malayalam Reader including the pictures of a journey you have made.





9

Hello.. Mic Testing...!!!

By learning this unit, the learner will be able to:

- ◆ play audio files using various audio and media players.
- ◆ connect microphone to computers and do necessary configurations for recording an audio.
- ◆ do audio recording using computers.
- ◆ edit audio files to make it perfect.
- ◆ recognize the features and play different audio formats.
- ◆ export various audio project files to different audio formats using audio editing software.
- ◆ import more audio files to new tracks and mix audio files with the help of audio editing software.



“അമ്മ പറഞ്ഞതിനപ്പുറം മറ്റൊന്നു-
മില്ലാതിരുന്നെരാപ്പോയ കാലം
മാവേലി നാടുവാണീടും കാലം, പാടി-
പ്പുനുള്ളിപ്പോയ പൊന്നോണക്കാലം...”



You have learned the poem **Puthuvarsham** written by Smt. Vijayalakshmi given in Kerala Malayalam Reader. Your teacher might have recited the poem melodiously in the classroom. Have you been fortunate to listen to any one else reciting it melodiously in different tunes? Did you try to recite the poem in a different manner?

In the era of computers and mobile phones, if we record and save poems and songs in these devices, we can enjoy them over and over again whenever needed.

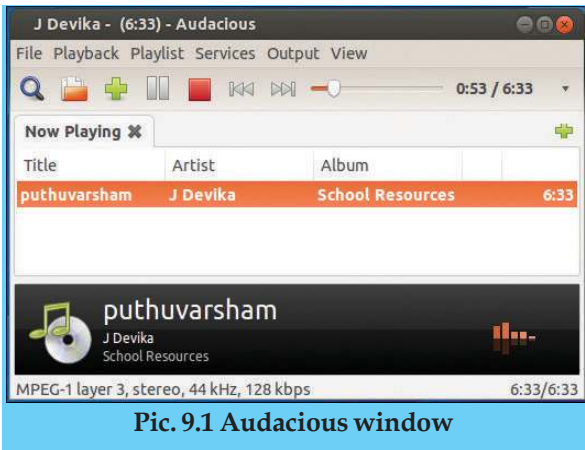

Pic. 9.1 Audacious window

Activity 9.1 Listening and enjoying a poem

Let us listen to the poem puthuvarsham.mp3 included in the folder audio_files in the menu School Resources for 8th Standard in the IT@School GNU Linux.

Double click on this audio file. In which software is it opened? (Pic 9.1). Connect a speaker or head phones, if you are using a desktop computer.

Audio player of IT@School GNU Linux



Pic. 9.2
Audacious Logo, Rhythm box Logo

GNOME Mplayer, SMPlayer, VLC media player and Xine are the medeia players in IT@School GNU/Linux compatible for playing audio files.

Find out whether there are any audio players in your computer other than Audacious, which you have used just now. Check for any other audio player software in which you can play these audio files.

Arrangements of mic and sound

If we want to recite and record the poem **Puthuvarsham** and then play it for others, what steps do you follow?

Hello.... Mic Testing...!!!

At first, we have to input our voice into the computer. Which input device has to be used for this?

Yes. We should connect to a microphone and make necessary arrangements.

Connect the microphone to the audio input port of the computer. (Pic. 9.3). Click on Audio Applet icon  on the top panel of the Desktop Screen and select Sound Settings option to open Sound Setting window. Now, drag the sliders in the Input and Output tabs and make suitable settings to these. (Pic. 9.4).



Pic.9.3 Microphone and its connecting port

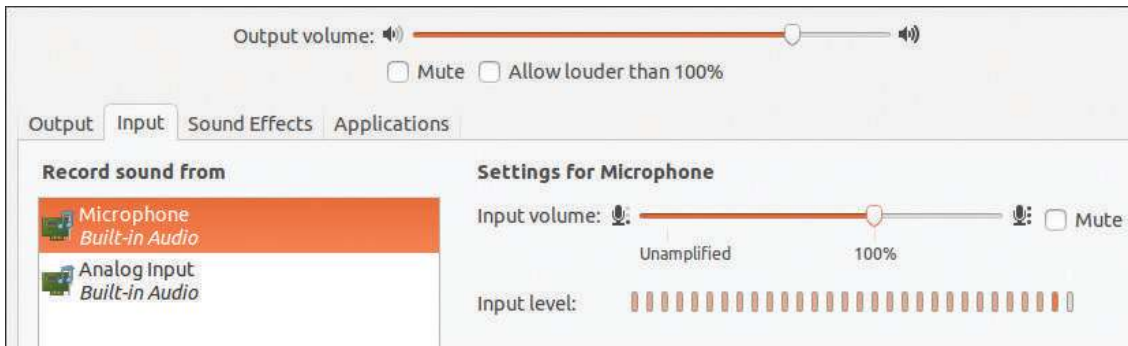

Pic. 9.4 Sound Settings window

If we are using Laptops, do we need to connect Microphone for voice recording?



Phonograph and Gramophone

Fifty to hundred years back, pre-recorded music disks called Gramophone records were used for listening to music. Music was recorded creating small grooves of different depths engraved on a disc. In order to play the music, a stylus was run through the grooves. This was the technology used in its. Phonograph is considered the first device used for recording and playing sound. Gradually, Phonograph was developed into Phonograph Cylinder and later refined to the Gramophone.



Pic. 9.5 Gramophone (Phonograph)

Audacity, an open source audio editor



Pic. 9.6
Audacity logo

Dominic Massoni and Roger Dannenberg developed an open source audio editor software in the year 1999 as part of their research project. Even though it was a venture of two persons, now almost a hundred volunteer developers including twelve main developers are working behind this wonderful audio editing software. Since Audacity is distributed under GNU GPL (GNU General Public License), anyone can use and modify it freely. Audacity versions are available in all leading operating systems like Microsoft Windows, Mac OS, GNU/Linux and you can freely download its versions.

Visit www.audacityteam.org for more details.

Audio recording

We learned that to play a sound file, we should have Audio Player or Media Player in the Operating System. Similarly specific softwares are needed to record a poem in the computer.



Audacity, Adobe Audition, Gold Wave, ACID Pro are some of the audio mixing software widely used nowadays. Of these, we use Audacity, a free software. The provisions for audio recording and audio editing are invariably found in all these audio editing softwares. Sound recording, Sound editing and File exporting can be done using Audacity.

Poem, in our voice!

Hope the microphone is connected to your computer and the audio settings are done. Now, you are ready to recite the poem.

Follow the given instructions to record the poem using Audacity software.





Activity 9.2 - Recording a poem

- ◆ Open Audacity software.
- ◆ Activate Record button  in the Transport Toolbar (Pic.9.7). (A wave form indicating the sound recording is seen).
- ◆ After reciting the poem fully, press stop button  to stop recording.
- ◆ Now let's save the file using File → Save Project to the folder Sounds under the folder of your class in the /Home/Student_Works_8. (Create your class folder and Sounds folder, if not created before, while saving). Note that audio projects are saved with the extension .aup.



Pic. 9.7 Transport Tool Bar of Audacity

Hello... Mic Testing...!!!

Use PLAY button  to play the recorded poem, use STOP button  to stop playing. We use PAUSE button  to pause playing and to resume playing press the PAUSE button once more. You can use the SKIP TO START button  to reach the beginning of the recorded poem and SKIP TO END button  to reach the end of the recorded poem.

You can also use Space Bar of your keyboard to PLAY and STOP audio files alternatively.

Activity 9.3 Editing the poem

Suppose after pressing the Record button, a delay of a few seconds occurred before the actual recitation of the poem.

Oh! I cough in between. Should I recite once again?

That non-recorded portion in the beginning and corrupted area in between the recorded portions can be removed. Don't bother about the non-recorded portion or the corrupted area of the recording or the unwanted noise that has crept in. All these can be edited and corrected using the editing provisions in the Audacity software.



Open the audio project of the poem that we recorded earlier using Audacity.

- ◆ The unwanted portion in the beginning and or at the end should be removed. For this select the portion and press Delete button of your keyboard.

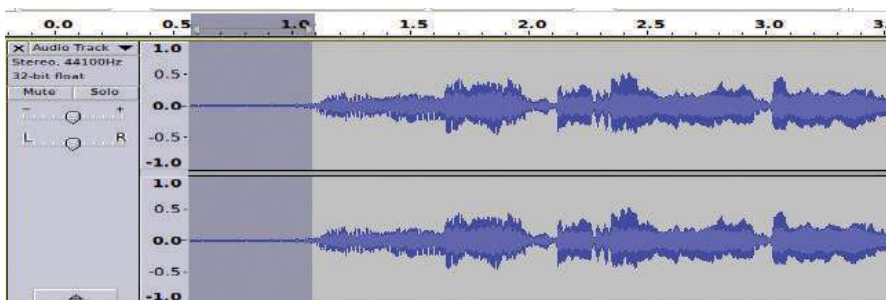

Pic. 9.8 Editing window

- ◆ The corrupted part, non recorded part or unwanted noise crept part, etc. found in between the recording can be removed similarly.
- ◆ You can use Cut, Copy, Paste activities to rearrange the position of the selected part of the recording. For

Caution

If you do not select a region for editing, then the editing will be effected to the whole audio file in the Audacity window.

- ◆ example, suppose the first four lines of the poem are repeated many times in the later portion. In that case, copy the first four lines and paste it to the desired place in the audio track.
- ◆ If we think certain parts of the audio track are not up to the mark, then rerecord those parts and copy-paste them to the corresponding positions.

A certain part of the recording has low volume. Can we amplify the sound of that part alone?

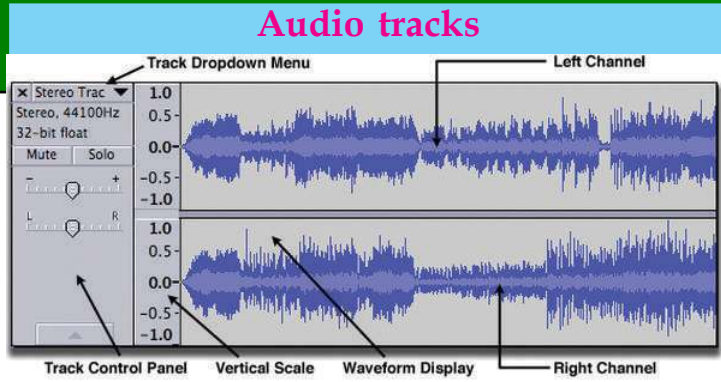

Pic. 9.9 Stereo audio track

When we record a voice using Audacity, Audio Track is the area where the Wave Form, Vertical Scale and Control Panel are shown. You can see the stereo track in Pic.9.9. If you record or import an audio without selecting the track, such audio files will be recorded or imported to a new track. You can add any number of tracks and use them one by one. Normally the upper portion of the stereo track denotes left channel and lower portion denotes right channel. In a mono audio track, Wave Form and Vertical Scale will be only a single track for both.

More effects

Hope you have removed all the corrupted portions in your audio that is recorded.

What else is to be done next to make the audio perfect? Do you feel the intensity of the audio is the same everywhere? We can rectify any difference in intensity in your recording.

Hello... Mic Testing...!!!

Activity 9.4 - Giving more effects

- ◆ Select the portion to be amplified.
- ◆ Choose Amplify option in Effect Menu.
- ◆ Adjust the New Peak Amplitude (dB) slider to increase and decrease the volume intensity and set it at the desired level (Pic. 9.10).
- ◆ Click OK to apply the settings.



Pic. 9.10 Amplify window

Is OK button not active? (The changes you have made in the New Peak Amplitude might have resulted in high amplitude which is not desirable. Hence, the OK button will not be active. In that case, to avoid distortion of sound, a clipping has to be effected). Activate clipping by putting a tick mark on Allow Clipping. Now the OK button will be active, and click to apply settings.



Don't stun your ears !!!

The unit of sound is decibel. Absolute silence is considered as zero decibel. Murmuring is of 30 decibel and normal talk amounts to 60 decibel. Hearing the sound greater than 80 decibels may damage your hearing.

Likewise we can activate more effects on the audio files using Audacity. Do you wish to include more effects on your audio file?

Try different effects that you wish to include. If any effect becomes uncomfortable or undesirable, you can cancel the action using Undo option. Audacity permits any number of Undo/Redo options.

If you have the habit of watching TV and playing audio system with high volume for long hours, please avoid those undesirable practices for the safety of your ears.

Activity 9.5 Completing the table

After experimenting with different effects in the Effect Menu, fill up the table given below.

Effect	Usage
Fade in	To increase the intensity of the selected audio part from silence to the original intensity.
Fade out
Change Pitch	To increase or decrease the pitch of the selected part.
Change Speed
.....

Table 9.1 Effects and their uses

Playing the poem in audio player

The poem saved with .aup extension can be opened for editing in any computer in which Audacity software is installed. But to play it using Audio/Media players or to use it in webpages and presentations, we have to convert the recorded audio from Project Format to Audio File Format.

Now, we shall learn how to convert the Project format to different Audio File format using Export Audio option in Audacity

Audio File Formats

Uncompressed audio formats

This is the best file format for saving original audio files. Though such files have bigger file size, its quality of sound would be high. Eg: .wav, .aiff

Lossless compressed audio formats

In this file format, the files are stored in a compressed manner without losing any information. Original Compressed Format can be regenerated from this format. Eg: .flac, .alac (Apple)

Lossy compressed audio format

In this file format, data is saved by omitting certain information and that leads to the decrease of the file size. At the same time the quality of the sound is compromised. Eg: .mp3, .ogg, .amr

Activity 9.6 Playing the poem

Exporting Audacity Project Format to other Audio File Format.

- ◆ Select Export Audio in the File menu.
- ◆ An Export Audio window opens up. Type the file name, select the folder where the file is to be saved and the format in which the file is to be exported (here let us select .mp3). Press save button. (Pic.9.11)



Pic 9.11 Export Audio window

In the window that appears, give more details about the file if needed.

Hello... Mic Testing...!!!

Sing or not?

Now, you are familiar with different audio formats.

All the media players may not be able to handle all the audio formats.

In such cases, one audio file format has to be converted to another audio file format. We will study the conversion in higher classes.

Activity 9.7 Identifying audio files

You can see different audio files in School Resources in your computer. Identify the audio formats seen there.

Play all these audio files in different audio/media players and fill up the table given here.

Extensions	Compatible Players
.wav	
.ogg	
.mp3	
.amr	
.....	
.....	
.....	

Table 9.2 Compatible players for different audio file formats

Combining introduction and background music

Play your exported poem in any one of the audio players. How is it?

Don't you feel that an introduction to your poem and also a background music will make the poem more appealing?

Let's do the audio mixing using Audacity.

For this, an introduction and a suitable background music should be kept ready. This can be done as you have exported your poem in mp3 format.

For the time being, you can use the introduction and background music in the audio_files folder in School Resources for 8th Standard.

Activity 9.8 Mixing audio files

- ◆ Open the poem in Audacity software.
- ◆ Import two files Narration .mp3 and bgm.mp3 from the folder School resources for 8th standard -- Audio Files using the option File -- Import Audio.



More opportunities !

Resul Pookutty from Kerala won the Oscar Award for the best audio mixing. The audio mixing done in the film 'Slumdog Millionaire' won him this award. More and more opportunities are waiting for sound engineers in the field of cinema, TV channels, radio stations, advertising, firms, animation studios etc. Dedication, hardwork, patience, keen interest in music are all essential for one to become a successful sound engineer.

After importing, you can see these files in two separate tracks (Pic. 9.12).

Now shall we play the poem?
The poem, introduction and background music are played together. Is it not?

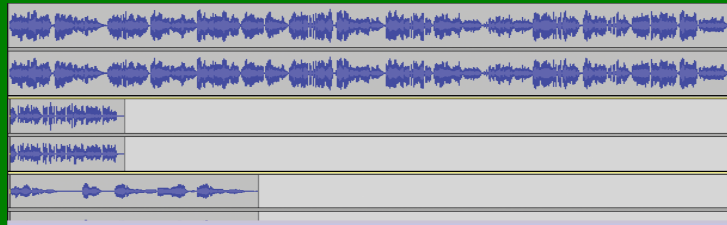

Pic. 9.12 Window consisting of Three tracks after importing

First we should hear the introduction. For this, move the poem track to the right till the introduction track ends.

You can use Time Shift Tool  to drag the audio track. Here, drag the Time Shift Tool rightwards so that the poem starts after the introduction track ends.

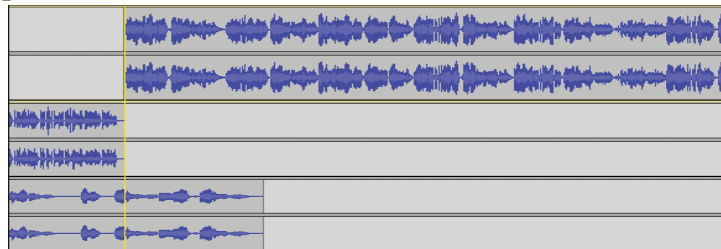

Pic.9.13 Track window after dragging the first track rightwards

Now, play the tracks again. You can hear the introduction first and then the poem. But what about background music? Some alterations are still to be made.

- ◆ We have to split the background music and place it at different positions. For this, first place the cursor to the position where the track has to be cut. Then select Edit - Clip Boundaries - Split. Now the track is cut into two pieces.

After splitting, move the track to the desired position using the Time Shift Tool.

While using these tools, it is preferable to use the Stop button than using Play-Pause button.



Pic.9.14 Tools Toolbar



Selection: This tool is used for placing the cursor anywhere in the track and also for selecting certain portion of the track by click and drag.



Envelope: Using this tool, we can increase the intensity of the sound track area where you feel the intensity is low.

Hello... Mic Testing...!!!



Draw: To edit the nodes of the wave form.



Zoom: Left click on the wave form to zoom in, and right click on the wave form to zoom out.



Time Shift: To move wave form leftwards and rightwards.



Multitool: For handling all the five tools.

Now, split and join the poem track and background music track appropriately.

See how the bits of background music is copy-pasted to the areas wherever necessary.

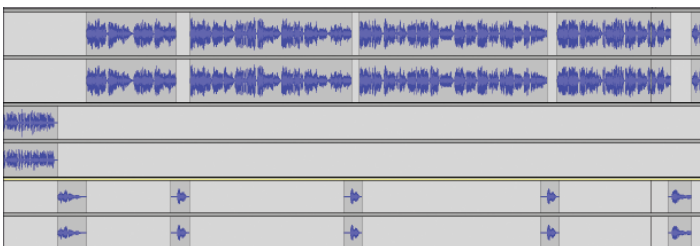

Pic. 9.15 Window before exporting

Come on everybody. Listen to my recitation.

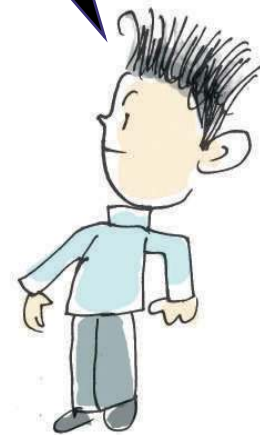

- ◆ Play the tracks. If you find it pleasing and satisfactory, save and export it.

The poem which is recorded, edited and mixed by yourself is now ready. Play it to your friends proudly.







Let's Evaluate

1. The file 'Puthuvarsham.aup' created in Audacity cannot be played in audio players and media players. Why?
2. Match the effects and their usages given in the table

Amplify	Starting with silence and to original intensity in an ascending order.
Change pitch	To increase or decrease the existing level of intensity.
Fade out	To ascend or descend the intensity of waveform.

3. Two formats of the same song are Song.wav and Song.mp3. Identify the two correct statements from the four statements given below with respect to the format Song.wav.
 1. It is a Lossy Compressed Audio Format.
 2. The file size is low compared to Song.mp3.
 3. It is a Compressed Audio Format.
 4. The file size is high compared to Song.mp3.
4. Match the tools and their usages in the table below:

	Left click to Zoom In and Right Click to Zoom Out.
	To alter the intensity of the sound at a particular point.
	To move wave form right or left in a time line.
	To edit a wave form independently.



Follow-up activities

1. Open Audacity software and import any audio file from the folder audio_files under the IT@School GNU Linux School Resources for 8th Standard. Cut any four lines from that audio files and export to .mp3 format.
2. Open Audacity Software and import Narration.mp3 and puthuvarsham.mp3 from the folder audio_files under the IT@School GNU Linux/School Resources for 8th Standard. Place the the audio Narration.mp3 before the audio puthuvarsham.mp3 and do the necessary sound mixing. Then export the file in .wav format.
3. Narrate and record the story **Ammamma** written by P. Surendran in your Malayalam Reader with expression and feelings. Add an introduction audio text also. After completing the editing and mixing, export it to .mp3 format.

Hello... Mic Testing...!!!

4. Recite and record the poem **We are the World** from your English Reader. Include an introduction audio text also. After necessary editing and mixing, export it to .wav format.
5. Recite and record the poem 'सुख-दुख' in your Hindi Reader, Unit II. Append an introduction audio text to the poem . After necessary editing and mixing, export it to .ogg format.
6. Write and record a small drama of the radio_drama type with your friends collaboratively. Do the editing and mixing . Save and Export as .mp3 format.
7. You have studied the travelogue of a journalist describing his experience in the minefield in your Social Science textbook. Assume that you are preparing the article. Write the narration and record the article with the help of Audacity Software. Export it as an audio file.



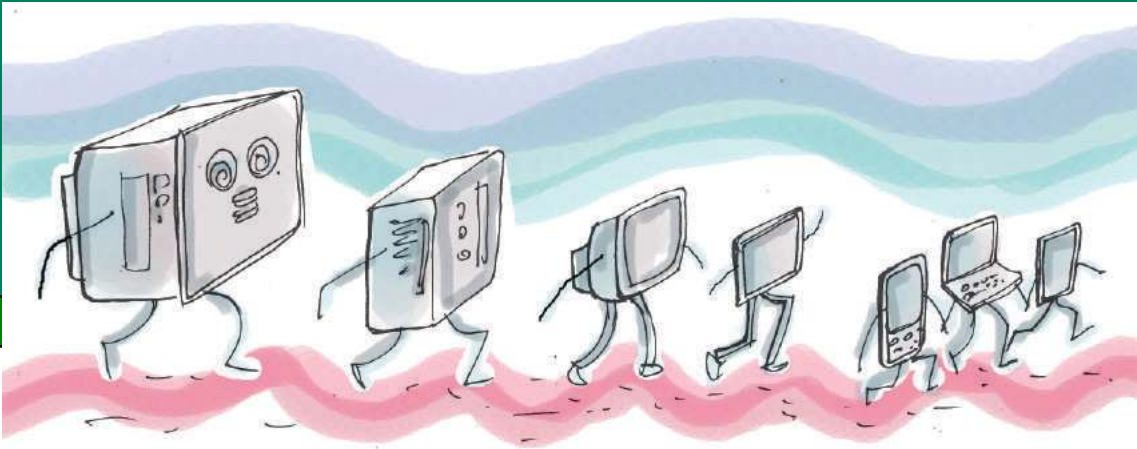

10

My Computer

By learning this unit the learner will be able to:

- ◆ understand the changes in computers and technology and prepare short notes.
- ◆ collect information about the major inventions related to computers.
- ◆ categorise data as text, image, sound etc.
- ◆ identify input devices compatible for processing different types of data.
- ◆ acquire an understanding of various application softwares and prepare short notes.
- ◆ change the desktop interface settings.
- ◆ configure the system settings.

3D printing : Build a house in 3 hours!

How many days are required to construct a two storeyed building? Most probably not less than six months. But in Shanxi Province in China, a two storeyed house was constructed in just 3 hours. Do you think it is possible? But it is a fact. With the help of 3D printing technology, each part of the house like doors, windows, walls, etc. were printed in heavy 3D printers and later joined using cranes. The raw materials used for the construction of the house were recycled factory wastes!



The above news indicates how man makes use of the giant leaps in technology. Computer technology has grown to great heights. What were the inventions that led man to this modern era of technology. Let's examine each stage of technological growth in the world.

The history of computers

Examine Pic. 10.2 and discuss in detail the evolution of the computer in each stage. Make short notes about these stages.

Charles Babbage

Charles Babbage was a mechanical engineer who lived in England. During the first quarter of the 19th century, he designed a machine for mathematical calculations. *The Difference Engine*, was a machine to perform mathematical calculations only. It was his first product. Soon after, he designed another machine called Analytical Engine which was operated by instructions and was capable of doing general computations. This was the first computer in the world. Therefore the world honoured him by calling him the Father of Computers.

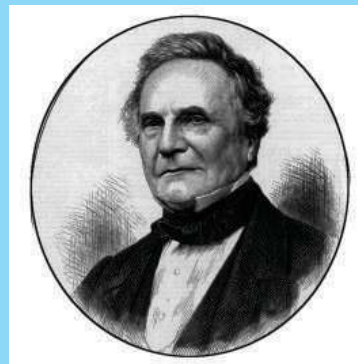

Pic. 10.1
Charles Babbage

Collect more details by visiting the wikipedia. (en.wikipedia.org/wiki/Charles_Babbage)

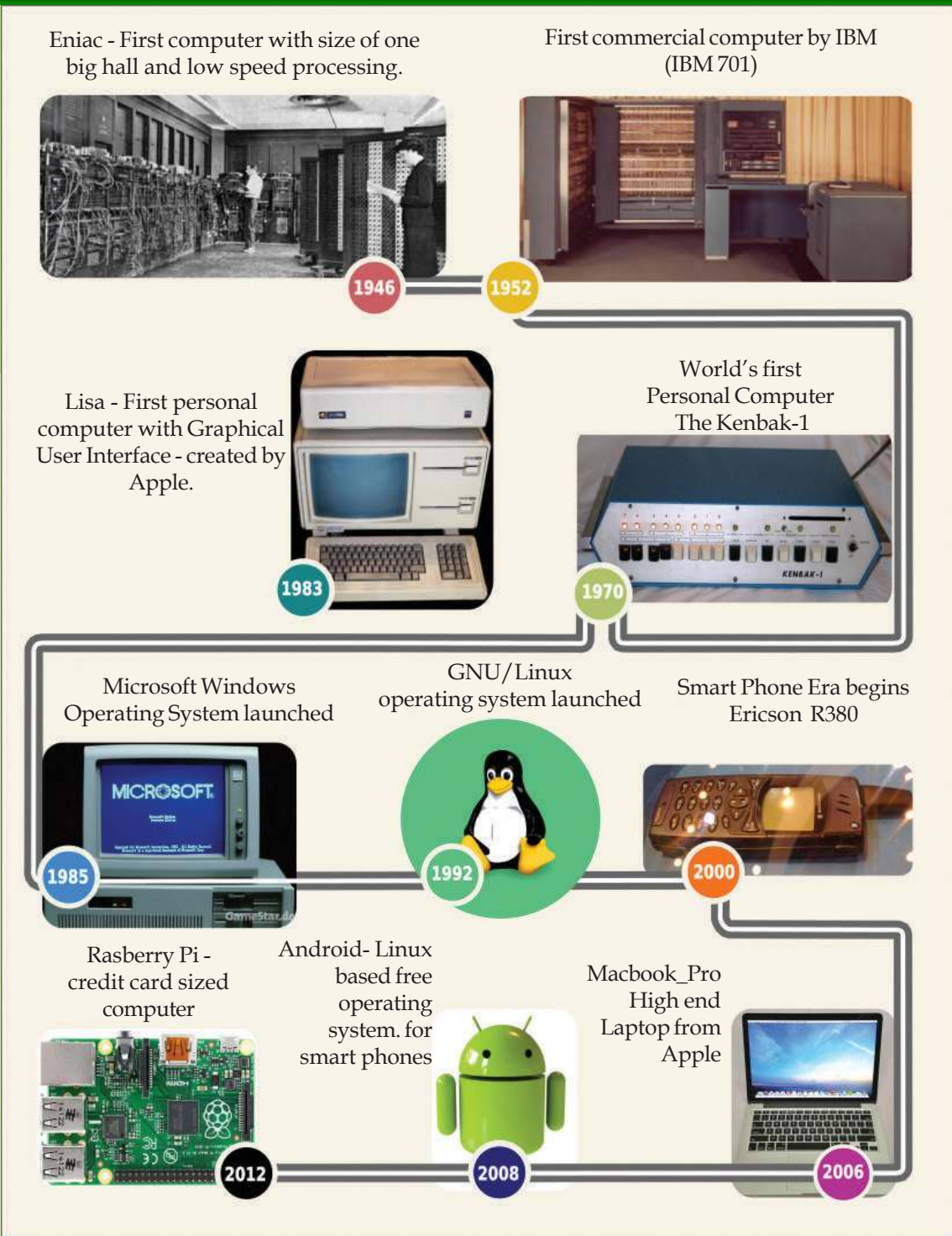

Pic.10.2 Timeline of computers

Computer is a machine that can perform many tasks like receiving, storing and processing information. What are the innovative changes in its later development?

Activity 10.1 Identifying evolution of computers

The table shown below depicts the evolution in the shape of personal computers (Table.10.1). Collect more information and try to fill up the left out columns.



System	Characteristics
	<ul style="list-style-type: none"> ◆ Has the structure suitable to be placed on a table. ◆ System unit is the main component. ◆ Mouse and keyboard as input devices. ◆ Monitor as an output device.
	
	

Table 10.1 Characteristics of computers

Data - Oh ! How many types?

In the early days, computers handled only text data. But do you know how many types of data are handled by modern computers? We have already learned about it in previous units. Can you recall some of them?

- ◆ Text
- ◆ Sound
- ◆



We have learned how these data are entered into a computer. We know that to input a data, a compatible input device is to be connected to the computer. What about retrieving data? Do you know how data is retrieved? Here also, to retrieve the processed data we should connect appropriate devices. These devices are called output devices.

Activity 10.2 Identifying and usage of various input/output devices

Complete Table 10.2 by adding more information to the blank spaces.

Device	Input/Output	Usage
Keyboard	Input	To enter text data
Mouse		To select what is seen in the screen
Microphone		
Camera		
Scanner		
Bar code reader		
Joy stick		
Monitor		
Printer		
Speaker		

Table 10.2 Usage of various devices

Activity 10.3 Preparing shortnotes on input/output devices

What are the main input and output devices used in computers nowadays? Prepare a short note on each of them. Some of these devices in the list are:

- ◆ My Computer
- ◆ Keyboard
- ◆ Mouse
- ◆ Monior
- ◆

Mouse

Right Button
Context Menu
(Shortcut Menu)



Left Button
Select, Drag,
Double click

Scroll Wheel
Move and zoom
pages, etc.

The prototype of the mouse that we use today was developed in the year 1960. Douglas Engelbart, an American Computer Engineer invented it. The mouse helped the computers a lot in making them so popular among the common people. First generation of the mouse worked with the help of a freely moving small metal sphere kept at the bottom of the mouse. Later, the working of the mouse with the help of light rays called optical mouse came into existence.

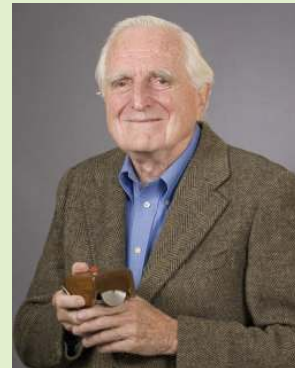

Pic. 10.3
Douglas Engelbart

Activity 10.4 Identifying the type of data for different input devices

See Table 10.3 and the images. Find out the data matching each of the device and complete the table.



Device	data
	
	Image, Movies
	

Table 10.3 Devices and types of data

Input or output?

Touch screen is used as an input device as well as an output device simultaneously. Now, touch screen technology is widely used in smart phones, tablets, ATMs (Automated Teller Machines), Laptops etc. Bent Stumpe, a Danish Electronic Engineer, designed and developed touch screen in the year 1972 and thereby started the era of touch screen. Earlier, touch screens were controlled by touching with a specially designed pen called Stylus. Later, touch screens controlled by our finger touch was developed and it monopolised the technology market. Touch screens substitute keyboard, mouse and monitor facilities.



Pic. 10.4 Touch screens

For more details, visit en.wikipedia.org/wiki/input/output, en.wikipedia.org/wiki/touchscreen

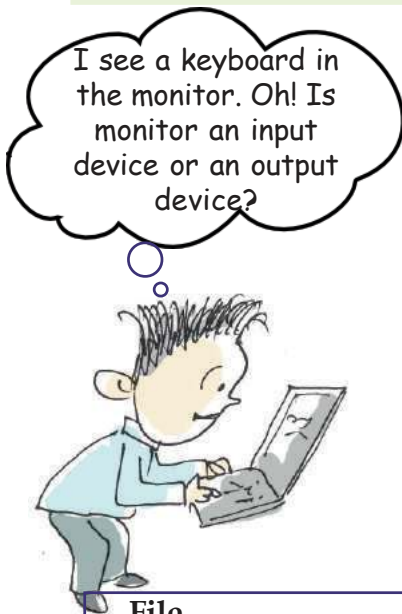

Computers and its peripherals operate with the help of a pre-installed set of instructions. These instructions are commonly called softwares.

Softwares - Let's know more about them

Activity 10.5 Identifying the file type and required software for different applications.

We know that a computer can do a lot of activities with the help of specific softwares. The table given below contains files, file types and their respective softwares. Fill up the left out items and complete the table.

File	File Type	Application Software
Leave application	Text	LibreOffice Writer
Marklist		
Slide presentation		
Drawing picture		
Record voice		

Table 10.4 File type and software for different applications

My Computer

Softwares and their functions are listed in the previous table. Softwares are commonly known as Application software.

To run these application softwares, the computer should have some additional facilities. What are they?

Operating system

Operating System is the main software that acts as an interface to accomplish a user's activity on computer. GNU/Linux, Mac-OS, Microsoft Windows, B.S.D, Unix are some of the prominent operating systems.

For more details visit:
en.wikipedia.org/wiki/Operating_system



Pic. 10.5 Computer Operating System



Pic. 10.6 Mobile Operating System

Mobiles also have Operating System

Mobile phones that we use also work with the help of an operating system.

Andriod, Apple iOS, Symbian, Blackberry OS are the some of the mobile operating systems. Moreover, now we have mobile versions of Windows and Ubuntu as mobile operating systems.

Andriod from Google is a Linux-based free mobile operating system. Linux based mobile operating system was a turning point in the multipurpose mobile phone scenario and also caused depreciation in the price of mobile phones. Today, e-Commerce as well as m-Commerce (online commerce using mobile phone technology) has been flourished since the advent of low cost multipurpose mobile phones.

For more details visit:
en.wikipedia.org/wiki/Linux_for_mobile_devices

en.wikipedia.org/wiki/Mobile_operating_system

- ◆ arrange the application softwares and be able to use them conveniently when required.
- ◆ manage all input, output and storage devices.
- ◆ store the files created using the application software in a schematic manner.
- ◆ communicate with the user computer and provide him a conducive atmosphere to work on it.

At last, I am free too!



Softwares giving such provisions are called Operating systems.

Let's learn and copy

Operating systems and Application softwares are available under two categories: Free Software and Proprietary Software.

The proprietary software from commercial interested companies are meant for a single user. Users

Free Operating System

Even though computers were developed earlier, the operating systems were designed later. When personal computers became popular, the computer world started thinking of an operating system which can be easily managed by a user. In 1980, Apple Corporation came with world's first Graphical User Interface Operating system called Mac OS. Later Microsoft launched Windows operating system.



Pic.10.7 Linus Torvalds & Richard Stallman

These operating systems can be used only with the permission of the concerned companies and also restricted the freedom of the user in many ways. This led to the idea of a free operating system. In 1992, Richard Matthew Stallman of America collaborated with Linus Benedict Torvalds of Finland developed and launched a free operating system called GNU/Linux. Now, various versions of GNU/Linux are available for us. Department of Education, Kerala State recognised the importance of the free software and declared GNU/Linux as the official operating system. Many Government departments in the state are now switching over to the free software.

My Computer

are restricted from copying or manipulating the software. But free software gives us the freedom to use the software for any purpose, to edit the source code and incorporate changes and to copy it.

We know that operating systems provide a conducive platform for the application programs to work on it. Do you know which operating system is used in your school? What are the facilities provided in it? Let's see one by one.

Beautification of the desktop

The computers in our school work with GNU/Linux operating system.

The desktop of this operating is seen in Pic.10.8.

Do you wish to change the desktop background?



Pic.10.8 IT@School GNU/Linux Desktop

The steps given below will help you to change the desktop.

- ◆ Place the mouse pointer on the empty space of the desktop and click the right button of the mouse. Select Change Desktop Background option (Pic. 10.9)
- ◆ Select the picture you like from Images displayed under the wallpaper section of the window that appears (Pic. 10.10).



Android watches



Wearable computers are also popular now. Latest Android versions are used in these devices. The operating systems of these devices are designed to run collaboratively with Android versions after the Android 4.3 (Jelly Bean). Therefore the operating system of such devices is known as Android wear.

Android watches, Android spectacles, etc. are now available in the market.

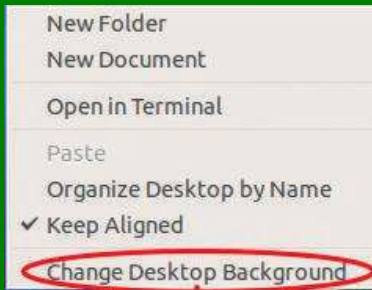

Pic. 10.9
Window for activating
Desktop settings

- ◆ Click on Add (+) sign (marked as 1 in the Pic. 10.10), you can set more pictures as background.
- ◆ Click on the combo box button (marked as 2 in the Pic. 10.10), you can change the theme.

Find out more options for the beautification of the desktop? We will learn about more advanced options in higher classes.

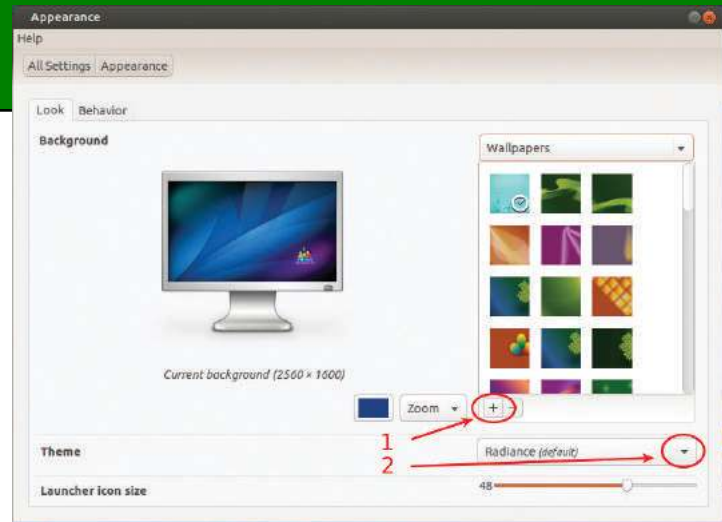

Pic. 10.10 Window for changing desktop settings



Folders to store files

You are familiar with the desktop of your operating system. Did you notice an important folder in the desktop?

The folder named Home is the main folder where the user's files are stored. You have saved all the activities done in the previous chapters in this folder. Do you know where you saved your activity files?

Find the path of a file

- ◆ Open your folder and right click on any of the saved files.
- ◆ Select Properties and carefully read the text shown against Location in the window that appears.

You see the text as /Home/..... What does it indicate? It indicates that your file is stored in the folder named Home or in the sub folders created inside the

My Computer

home folder of your computer. You will learn more about file path in higher classes.

Be careful while saving a file

A file will be generated as a result of a work done in the computer. Do not save this file carelessly with an unintended name and also in an unintended location. Always create a specific folder meant for it and save the file in that folder. Do not forget to give an appropriate file name while saving. This habit will help you to remember and retrieve the file later when required. Do

you know where the files are stored if they are saved without assigning proper name or exact location? Normally, according to the type of file, the computer will store such files in Home folder or in folders like Documents, Pictures, etc. seen inside the Home folder.

Rename a folder

How do you change the existing name of a folder? Place the mouse pointer over the folder and click on the right button of the mouse. Hope you got the option for renaming the folder from the window that appears. Now, change the folder's name.

System settings

Did you type Malayalam in computer? In the previous unit you have learned how to type Malayalam or any other language in your computer.

If we want to type a new language, don't we have to set the specific keyboard layout? What are the settings to be done?

Let's verify.

Click on the Settings button in the top panel.

Select System Settings from the window that appears (Pic.10.11).

Select Text Entry in the appeared window (Pic.10.12).



Drones



An era of Unmanned Aerial Vehicle (UAV) commonly known as Drones is forthcoming. The things you need will fly to your doorstep, is not a distant dream. The drone's technology and its usage are far developed beyond our imagination. Days have come where Unmanned Aerial Vehicles are used in war as well as in peace. Drones are used legally for wedding photo session, Television and film shooting, Aerial surveillance etc.

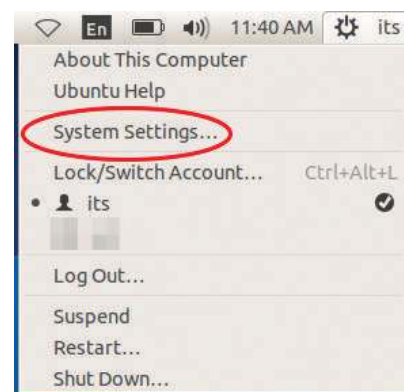

Pic.10.11 Window that leads to system settings

From the coming window Click + button and select the desired language and click Add button (Pic.10.13, 10.14).

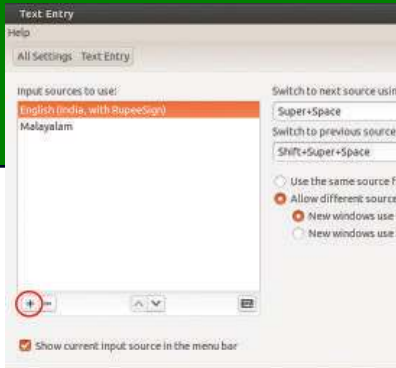

Pic.10.13 Text Entry Setting window

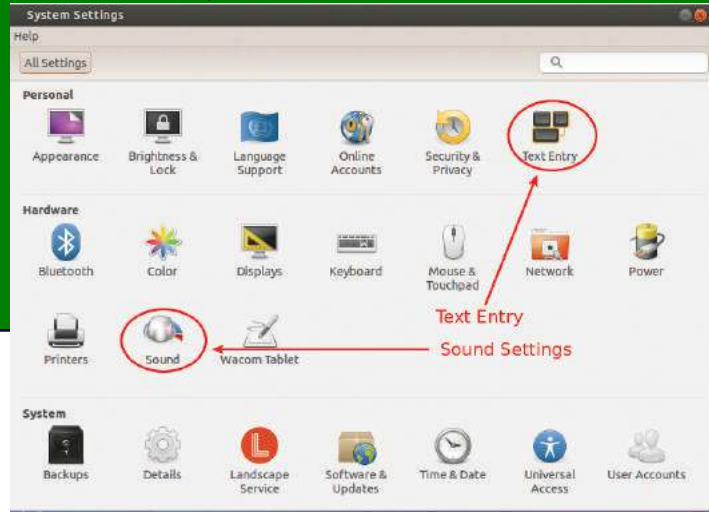

Pic.10.12 System Settings window

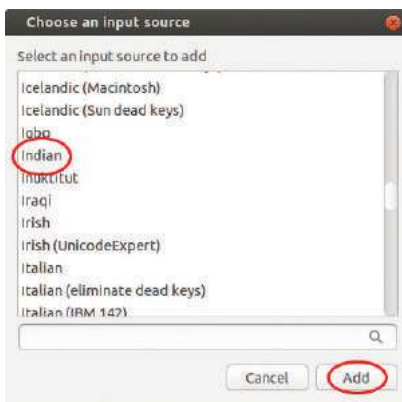

Pic.10.14 Window for selecting language

Let's Evaluate

1. What are the milestones in the evolution of computers from Eniac to Smart phones?
2. What are the common data handled in computers?
3. Prepare a table correlating data like Text, Image, Sound, etc., its compatible input/output devices and the appropriate Application Software.
4. Examine the table and fill up left outs.

Activity	Software Segment
To turn on a computer	Operating system
To draw a picture in a computer	Application software
To create a folder	
To type a poem	
To consolidate information	
To change desktop background	



Follow-up activities

1. Prepare a presentation for a seminar using LibreOffice Impress on the topic 'Computer Evolution from Eniac to Smart Phones'.
2. Collect pictures and information about main Input and Output devices of a computer. Then, prepare a presentation using LibreOffice Impress with the data collected.
3. Conduct a debate on the topic 'The Decreasing Difference between Computer and Mobile phone'.
4. Create a folder named ICT at home and also create three sub folders named Office, Gimp, Program inside ICT folder.
5. Change your desktop background to a background depicting flowers.
6. Open LibreOffice Writer and insert a table which should contain the following information in Malayalam. Various data types, its compatible Input/Output devices and its appropriate software.

