

BASIC SCIENCE

Part - 1

Standard V



Government of Kerala
Department of Education

State Council of Educational Research and Training (SCERT), Kerala
2016

The National Anthem

Jana-gana-mana adhinayaka, jaya he
Bharatha-bhagya-vidhata.
Punjab-Sindh-Gujarat-Maratha
Dravida-Utkala-Banga
Vindhya-Himachala-Yamuna-Ganga
Uchchala-Jaladhi-taranga
Tava subha name jage,
Tava subha asisa mage,
Gahe tava jaya gatha.
Jana-gana-mangala-dayaka jaya he
Bharatha-bhagya-vidhata.
Jaya he, jaya he, jaya he,
Jaya jaya jaya, jaya he!

PLEDGE

India is my country. All Indians are my brothers and sisters.

I love my country, and I am proud of its rich and varied heritage. I shall always strive to be worthy of it.

I shall give respect to my parents, teachers and all elders and treat everyone with courtesy.

I pledge my devotion to my country and my people. In their well-being and prosperity alone lies my happiness.

State Council of Educational Research and Training (SCERT)

Poojappura, Thiruvananthapuram 695012, Kerala

Website : www.scertkerala.gov.in

e-mail : scertkerala@gmail.com

Phone : 0471 - 2341883, Fax : 0471 - 2341869

Typesetting and Layout : SCERT

First Edition : 2014, Reprint : 2016

Printed at : KBPS, Kakkanad, Kochi - 30

© Department of Education, Government of Kerala

Dear children,

This book is your friend;
a friend who
asks you questions,
enlightens you with knowledge,
persuades you to keenly observe, know and search;
always a friend at your service.

Let us discover the science within the wonders seen around.
You will be able to soar into the sky of knowledge,
evoking nature's grace into your minds.

This book will accompany you
helping you to learn what you ought to,
persuading you to search for more, and
showing you what you imagined.

March ahead holding your teachers' hand
and discovering along with friends.

Regards

Dr. P. A. Fathima

Director,

SCERT

Textbook Development Team

Abdul Gafoor K V M
MUAUPS, Panakkad

Manoj Kottakkal
GRHSS, Kottakkal

Illyas Perimbalam
GVHSS, Nellikuthu

Sunandan T P
Akkara UPS, Kavasseri

Adatt Vasudevan
AUPS, Nellisseri

Ajith Prasad
Hindu UPS, Mullasserri

Varghese Mathew
GHSS Mancode

Mohandas P P
NNNMUPS Karalmanna

Robin K
GHS Kunnathukal

Rajeena S
GUPS Randathani

Jayanbabu K L
Vinobha Nikethan UPS,
Thiruvananthapuram

Experts

Dr Alaudeen M
Principal (Rtd.), Govt. College, Elerithattu

Dr S Mohanan
Reader & Head (Rtd.), Department of Physics, University College, Thiruvananthapuram

Paul P I
Associate Professor, Department of Zoology, Mar Ivanios College, Thiruvananthapuram

English Version

Dr Sushil Kumar R, Associate Professor of English, D B College, Sasthamcotta
Dr Vijayalekshmi V R, Reader (Rtd.), Department of Zoology, NSS College, Pandalam
Prof. Sebastian Lukose, Professor (Rtd.), University College, Thiruvananthapuram
Padma Chandran, Asst. Professor of English, Mar Ivanios College, Thiruvananthapuram

Sangeeth, HSST, GHSS, Ernakulam

Famila E R, HSST, GHSS, Karunagappally

Geetha Nair, HSST, GHSS, Chirakkara, Thalassery

K Suresh Kumar, HSA, AMHSS, Thirumala

Artists

Musthajib E C, MMETHS, Melmuri

Noushad Vellalasseri, Ganapath AUPS, Keezhisseri

Muhammed Shameem, VAUPS, Kavanoor

Lohithakshan K, Assisi School for the Deaf, Malapparambu

Vijayakumar, GUPS, Nemom

Academic Co-ordinator

Dr. Ancey Varughese
Research Officer, SCERT

Content

1. Know the Plant World Closely 07
2. Life-Giving Water 21
3. Celestial Shadow Sights 37
4. Life within the Seed 47
5. Energy Sources 59

**Certain icons are used in this
textbook for convenience**



**For further reading
(Evaluation not required)**



ICT possibilities for making concepts clear



Significant learning outcomes



Let us assess



Extended activities

1

Know the Plant World Closely

The vacation is over. How exciting it is to go to school with an umbrella, playing in the rain! When did you wake up today? Did you take enough food before coming to school? What did you eat today? Try to write it down.

Which among these food items did you get from plants?



The picture shows diverse food materials.

From where do we get them?

All are parts of plants, aren't they? Are you able to identify these plants?

Tabulate them down in your science diary.

- Root
-
-
-

Do we use only the leaf of amaranthus (*cheera*) for our food?

Haven't you seen cauliflower? Which part of it do we eat?

Expand the table by adding the names of plants whose stems and flowers we use as food.

We use different parts of plants for food. The edible part in each plant is different.

Do all plants have edible parts?

Observe the pictures. What do we use these plants for?



Pepper



Cloves



Turmeric



Ginger



Cardamom

We make use of plants as spices, medicines, and for many other purposes. Look at the picture. Common plants like adathoda, curry leaf plant, hibiscus, *kurumthotti* (common cida), *panikoorka* (Spanish thyme), neem and touch-me-not are shown in the picture. Spot out these plants from your surroundings and tabulate their uses in your science diary.



Can we imagine a world without plants?

All animals depend on plants for food.

Plants provide food for us. But where do they get their food from?



Photosynthesis

Plants absorb water through their roots. This water contains various minerals. Plants also absorb carbon dioxide from the atmosphere through minute pores present in their leaves. All these are done for preparing food. Preparation of food takes place in the leaves. This process is called photosynthesis. Sunlight and the pigment present in leaves called chlorophyll, are essential for photosynthesis. The product of photosynthesis is glucose. Oxygen is also formed along with this, and it is released during daytime. The glucose formed through photosynthesis is later converted into starch. Plants prepare their own food and are hence known as autotrophs.

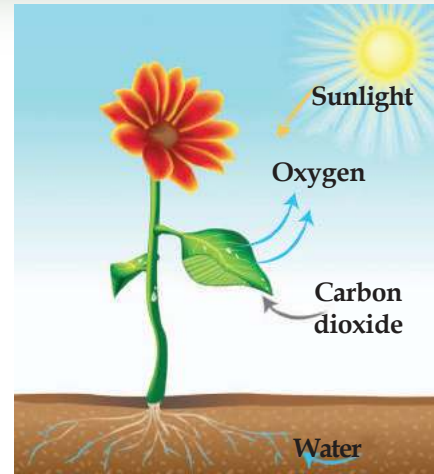

Complete the boxes given below.

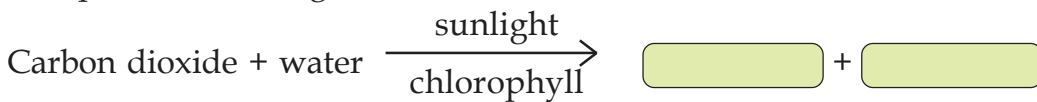

How do plants get carbon dioxide?

Try this activity.

Peel off a little of the outer layer from the lower side of a betel leaf or taro (colocasia) leaf. Dip the layer in dilute stain. Place this layer on a glass slide using a point brush. Observe this through a microscope. Don't you see pores in the leaves?

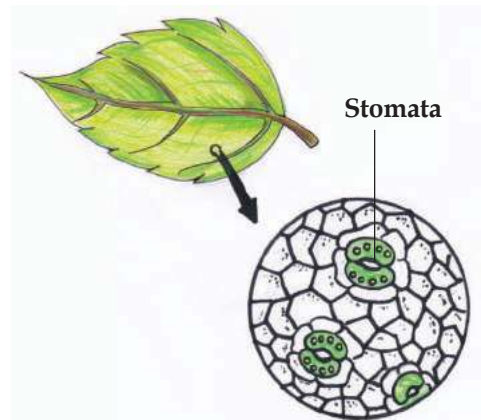

Stomata

Plants absorb carbon dioxide and release oxygen during photosynthesis. This gaseous exchange takes place through small pores in the leaves. These pores are called stomata. They also release water from plants to the atmosphere.

Draw the picture of the stomata you have observed through the microscope and write a note about this activity in your science diary.



See the video *Vathakavinimayam Sasyangalil* (Edubuntu - School Resource)

Observe the plants around you. On which part of the plant does the sunlight fall more?

Are leaves of plants arranged so as to get maximum sunlight? Write the result of your observation in the science diary.



Chlorophyll

The green-coloured pigment seen in plants is chlorophyll. Chlorophyll absorbs the sunlight needed for photosynthesis. It is present more in the leaves.

Are all leaves green in colour?

Haven't you seen the red amaranthus? Does photosynthesis take place in them?

Try this experiment.

Materials required : Leaf of red amaranthus; blotting paper.

Rub the leaf of red amaranthus on a blotting paper. Observe the colour change in the paper. Analyse the observations.

Write down the notes of the experiment in your science diary.

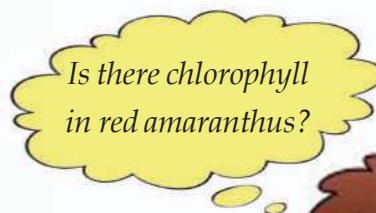

Didn't you realise that red amaranthus has chlorophyll?

If so, what could be the reason for its red colour?

Different colours

Observe the picture. Besides chlorophyll, other pigments are also present in plants. Hence leaves with the pigment xanthophyll appear yellow in colour, those with carotene appear yellowish orange and those with anthocyanin appear red in colour.

Are pigments present only in leaves?

In your science diary, explain the reason for the red colour of hibiscus and the yellow colour of sunflower.

Pigments give colour to leaves, stems, flowers and fruits.

Listen to what Baiju said to his teacher.

“Teacher, I have grown some plants in my bedroom. Won't there be enough oxygen released by the plants inside the house?”

Requisites of an experiment note?

- Objective
- Materials
- Procedure
- Observation
- Inference

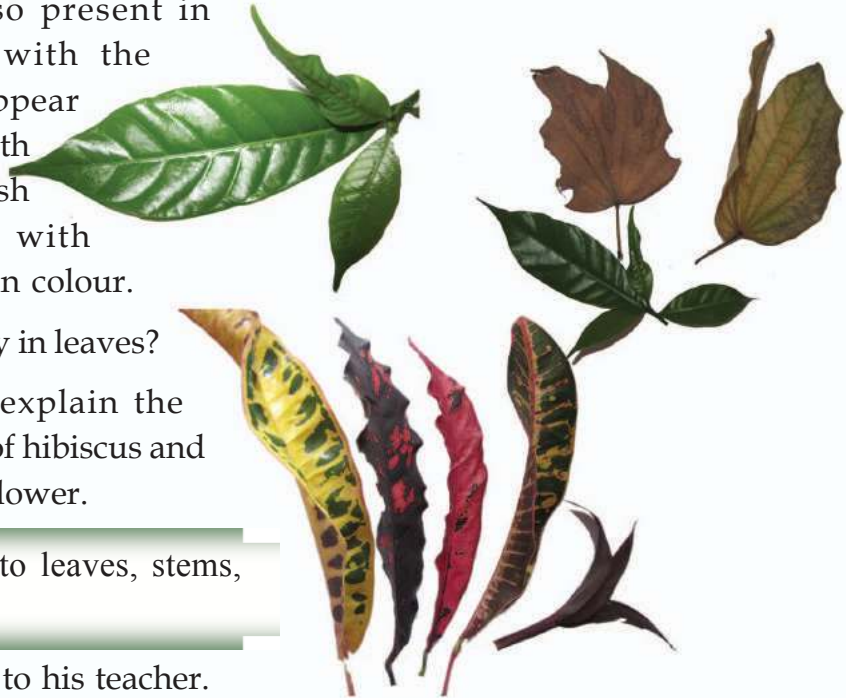

What is your response to what Baiju said?

Is there any benefit in growing plants inside the house? Will such an arrangement be helpful to get oxygen during the night?

Record your opinion in the science diary.

Photosynthesis and Respiration

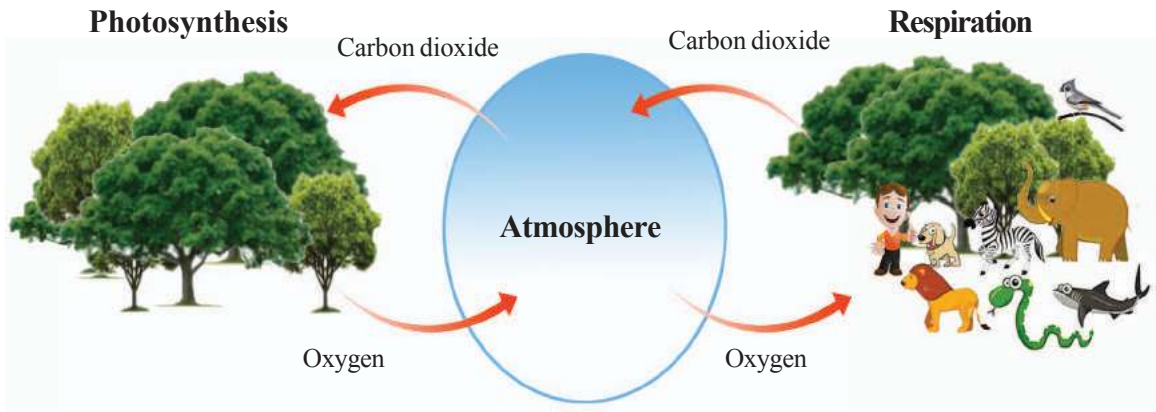

Observe the picture

- Do plants release only oxygen at all times?
- Is photosynthesis possible at night? Why?
- What is the process that takes place during the day and the night in all organisms, including plants?

Does a person, who sleeps under a tree during the night, receive more oxygen?

Write down your explanation in the science diary.

- When green plants carry out photosynthesis during daytime, carbon dioxide is absorbed and oxygen is released.
- Since photosynthesis does not take place at night oxygen is not released.
- All organisms including plants respire day and night. Oxygen is taken in and carbon dioxide is given out at that time.

A place to live

This is the diary note of Safiya who went on a study tour from school:

Today, we went on a study tour from school. The orchidarium attracted me the most. Orchidarium is a garden where orchid varieties are grown. How beautiful are the orchid flowers! What surprised me was the way these plants are being nurtured. They are grown on hanging wooden planks tied with materials like coconut fibre. Some others grow on branches of trees. They don't require soil to grow....



Different varieties of orchids



Vanda

Vanda is a common type of orchid seen in our locality. Look at the picture. Observe its thick roots. These roots have certain peculiarities. They can absorb moisture from the atmosphere. This is why these plants can grow even without soil. These plants depend on other plants only for shelter. Such plants are called epiphytes.

Have you now understood which category of plants do orchids belong to?

Will the presence of epiphytes affect host plants adversely?

Discuss and note down your findings in the science diary.

Parasitic plants

Haven't you seen the loranthus that grows on the mango tree?

Is the growth of loranthus on the mango tree beneficial? Why?

Even though loranthus has leaves and roots, it prepares food absorbing water and minerals from the host plant. Cuscuta is a light yellowish green climber which spreads over a plant. Does this climber bring any harm to the host plant? Discuss.



Loranthus



Cuscuta



Rafflesia

Some plants absorb food from the plants on which they live. They do not prepare food for themselves.

Rafflesia, the largest flower in the world, also belongs to this category.

- Plants that absorb water and minerals from the host plant and prepare their own food with the help of their leaves are known as semi parasites. Eg. Loranthus.
- Plants that absorb food directly from the host plants are total parasites. Eg. Cuscuta.
- Both semi parasites and total parasites harm the host plants.

Observe parasitic plants and write down their peculiarities and their harmful effects on the host plant, in your science diary.

From decomposed remains

Look at the plants in the picture. These plants grow absorbing nutrients from decomposed matter. Such plants are known as saprophytes.

Are you not familiar with fungi?
Where do fungi grow?



Neottia



Monotropa

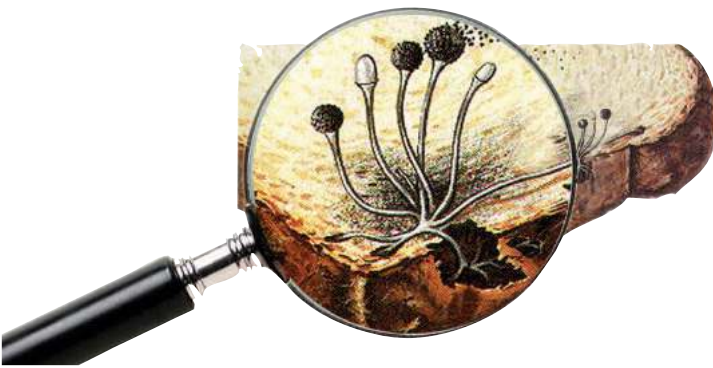

Bread mould

Try this activity .

Soak a piece of bread in water and keep it aside. Observe it through a hand lens after two days. In your science diary, draw what you have observed. Fungi growing on bread, pickle etc. are saprophytes. Fungi do not belong to the group of plants.

Mushrooms popping up like umbrellas are a familiar sight. They also belong to the group of fungi.

- Where are mushrooms found?
- Do they differ in colour, size etc?

Add more details about mushrooms in your science diary.



Mushroom

We have been discussing some of the plants that depend on other plants for food and shelter.

What about the pepper vine that grows on other plants? Why does it do so?

Lend support, make pandals...



Different kinds of vegetables

Visit a vegetable garden. What are the different kinds of plants found there?

Which are the plants that are provided with support to climb up?

Which are the plants that spread and grow on the ground?

Write down your observations in the science diary.

Observe the picture. You can see spring-like parts in the ash gourd vine. What are they for?



Tendrils



Pepper vine



Snake gourd



Bitter gourd



Gloriosa

Search for similar plants in your surroundings. Record their peculiarities.

Climbers

Climbers are weak-stemmed plants. They climb on other plants with the support of spring-like parts called tendrils. Some plants have clinging roots for this purpose. Plants like pepper, bitter gourd and snake gourd are examples.

You might have seen the sweet potato.

It is a weak-stemmed plant.

How does it grow?

Does it have tendrils?

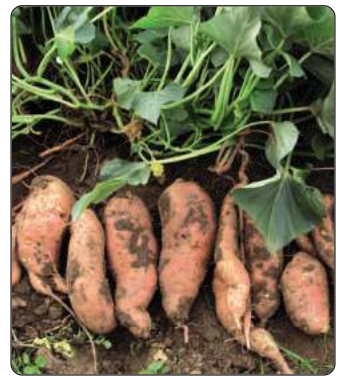

Sweet potato

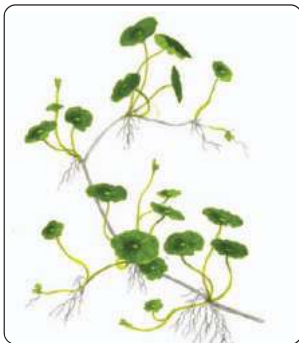

Hydrocotyle



Strawberry

Creepers

Weak-stemmed plants that grow creeping on the ground are called creepers. Sweet potato, hydrocotyle, strawberry etc. are examples. These plants do not possess tendrils or clinging roots.

Observe the creepers and climbers seen around us and classify them. Write them down in your science diary.

Diversity in roots



Banyan Tree



Screw pine

Look at the pictures. Do you notice roots growing downwards from the branches and the stem? How are these roots useful to the plants? Are there such plants in your locality? Observe.

Prop roots and stilt roots

Roots are used not only to absorb water and minerals but also to provide support to plants. Prop roots and stilt roots are roots seen above the soil to support the plants.

Roots seen in the banyan tree are prop roots. These roots grow downwards from aerial branches. But look at the roots in screw pine. It is from the stem that the roots grow downwards. These roots are called stilt roots.

There are more diversities among roots. Read the following note on mangroves.

Mangroves

Mangroves are special kinds of plants growing in marshy areas. The tip of their roots grow towards the atmosphere. These roots that help in gaseous exchange are called pneumatophores.

Collect more details and pictures of mangroves and prepare a wall journal.



Pneumatophores in mangroves

For storing food...

Observe the picture.

Aren't both edible tubers? Which of them sprouts when kept for some time? Why?

Write down your guess in the science diary.



Potato



Tapioca

Tapioca stores food in roots. Roots that store food in this way are called storage roots.

All tubers are not storage roots. Potato is a modified stem. Such stems seen below the soil are underground stems.

Classify the items given below into storage roots and underground stem.

- | | |
|-------------------|----------------|
| Carrot | Chinese potato |
| Beetroot | Arrowroot |
| Elephant foot yam | Tapioca |
| Colocasia | Sweet potato |
| Ginger | Turmeric |

Storage roots	Underground stem

Diversity in the world of plants



The world of plants is full of diversities.

Have you ever enquired about the plant diversity in your locality?

Examine the Biodiversity Register in your Panchayat office and

prepare a table of plants. Observe these plants and write down their peculiarities. Find out their significance as well.

Prepare a report of your findings and present it in the science club meeting. Prepare a Biodiversity Register after observing the plants in your school premises.

What trees provide

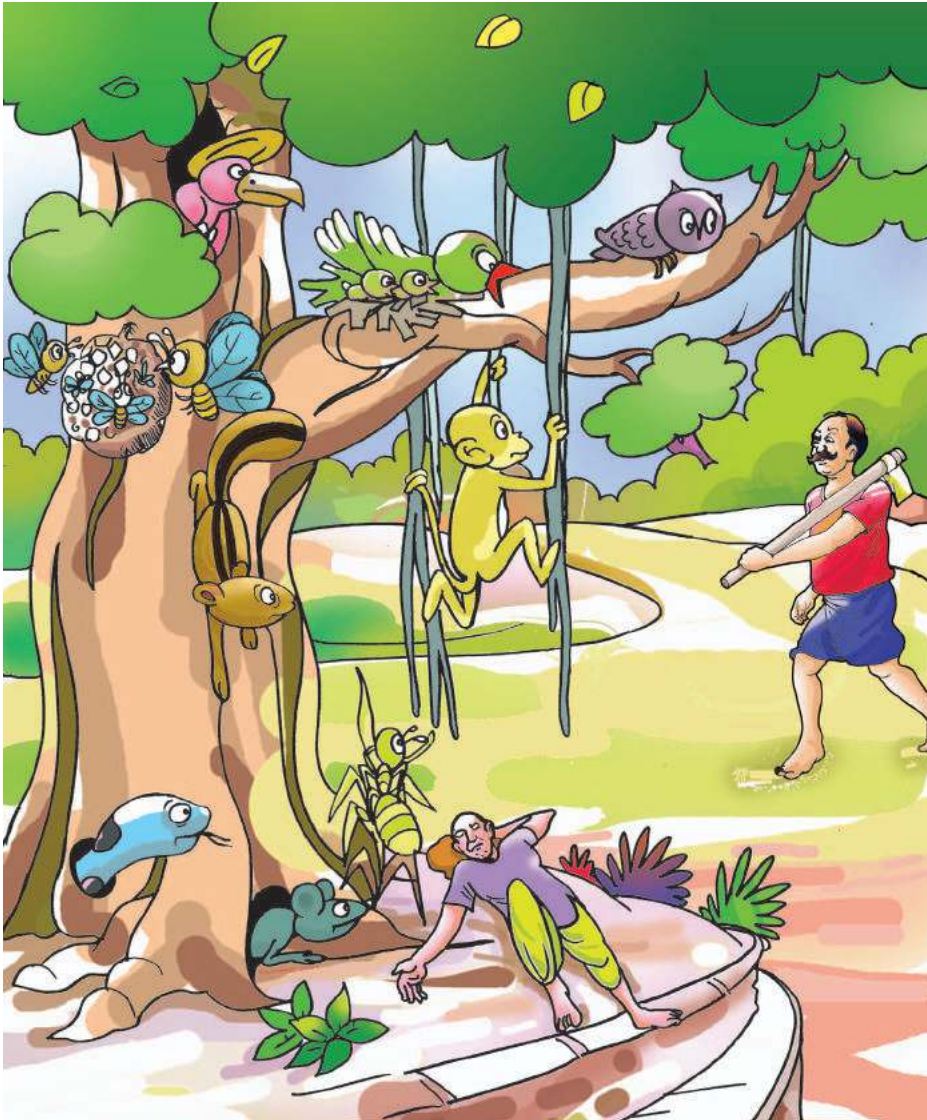

Which are the organisms that depend on trees?

In what ways do trees help them?

Observe the picture and record them.

Organism	How trees help
<ul style="list-style-type: none"> Bird 	Shelter, food

In the picture, do you see a woodcutter walking towards the tree? Just imagine what would happen to the organisms in the tree if it is cut down.

Isn't it our responsibility to protect plants? What can we do in this regard? Organize events to create awareness in your locality about the significance of protecting trees. Take up such activities and implement them.



Significant learning outcomes

The learner can

- identify and explain that plants with chlorophyll prepare their own food.
- classify plants into parasites and saprophytes and give examples.
- identify plants belonging to the category of epiphytes and explain their peculiarities.
- classify weak-stemmed plants based on their peculiarities.
- recognize the modifications of various parts of plants and their functions.
- realize the significance of plant diversity and suggest protective measures.



Let us assess

1. Classify the plants given below on the basis of suitable criteria.
Mango tree, Loranthus, Mushroom, Cuscuta, Paddy, Monotropa, Sandal wood tree, Rafflesia, Neottia, Vanda.
2. Loranthus, Vanda and Cuscuta, growing on nearby trees, started talking about their shelter and food habit. What would each one have to say? Try to write yourself.
3. According to Raju, the functions of the root are only to fix the plants in the soil and absorb water and minerals. How will you respond to his opinion?
4. While conducting an experiment on photosynthesis, Sajeesh pasted a black paper on a leaf of a plant in his courtyard as seen in the picture. What would have prompted him to do so?



Extended activities

1. Organize a field trip to a place abundant in mangroves. Prepare a report explaining the peculiarities and significance of the mangroves.
2. Observe and understand how leaves are arranged so as to receive sunlight.
3. Observe the various adaptations in weak-stemmed plants seen in your locality.



2

Life - Giving Water



These are some of the headlines in newspapers.

Isn't it due to the great importance of water in daily life that newspapers are always flooded with news related to it?

What do we use water for? Record them in the science diary.

- For drinking
- For cooking food
- For agriculture
- For washing vessels
-

Can we use anything other than water for these purposes? Pure water is colourless, odourless and tasteless. What are the other properties of water?

Making use of the pictures and table given below, discuss the properties of water and record them in the science diary.



Properties of water	Situations in which used
Dissolves substances	<ul style="list-style-type: none"> • For sweetening drinks • For washing clothes •
Flows	<ul style="list-style-type: none"> • Carried through pipes •
Carries heat	<ul style="list-style-type: none"> • For cooking •
Has no definite shape, takes the shape of the container	<ul style="list-style-type: none"> • Can be collected in vessels of different shapes. •
Exists in solid, liquid and gaseous states.	<ul style="list-style-type: none"> • Can make <i>puttu</i> using steam. •

Do all substances dissolve in water?

Soluble and insoluble substances

Examine the conversation between Haseeb and Anand after stirring sugar and sand in water taken in separate glass tumblers.

Haseeb : The sugar that I put into the tumbler has disappeared.

Anand : The sand that I put into the tumbler remains as such.

Let us try the experiment done by Haseeb and Anand. Take salt, sand, sugar, kerosene, coriander powder, potassium permanganate, sugar candy, chilli powder, coconut oil, blue vitriol (hydrated copper sulphate), stone and glycerine in separate glass tumblers. Add water and stir each of them. Tabulate your observations.

Water soluble	Water insoluble

Solute, Solvent, Solution

A substance which dissolves is called solute and that in which the solute dissolves is called solvent. Solution is that which is formed when solute dissolves in a solvent. In sugar solution, sugar is the solute and water is the solvent.

You have observed the dissolution of certain solids and liquids in water. Gases also dissolve in water to give solutions. Let us open a soda bottle. Don't you see gas bubbles rising up while opening a soda bottle? It is the carbon dioxide dissolved in water that comes up in the form of bubbles. If so, what is the solute in soda water?

The oxygen dissolved in water is what fish and various other creatures living in water breathe.

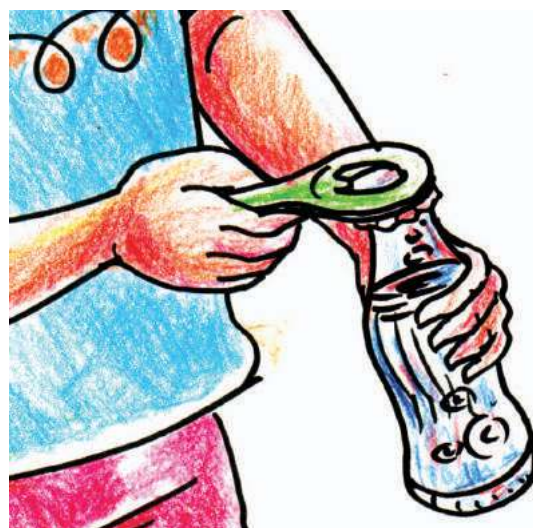

Complete the table writing separately the solute and solvent in each solution.

Solution	Solute	Solvent
Sugar solution	Water
Salt solution	Salt
Soda water
Potassium permanganate solution
Copper sulphate solution



Expand the table adding other solutions.

Universal solvent

Is it in water that more substances dissolve?

Complete the table after doing the experiment:

Solvent	Solute					
	Sugar	Salt	Blue vitriol	Jaggery	Sugar candy	Potassium permanganate
Water						
Coconut oil						
Kerosene						

Which is the liquid in which most substances dissolve? Do all water soluble substances dissolve in other liquids?

Water is a solvent which dissolves a large number of substances. Hence water is called the universal solvent.

What are the benefits of water being a universal solvent?

Let us discuss some other properties of water.

Water level

Make an arrangement as shown in the figure. Cut two plastic bottles into equal size. Put a hole at the base of each of the bottles. Insert the ends

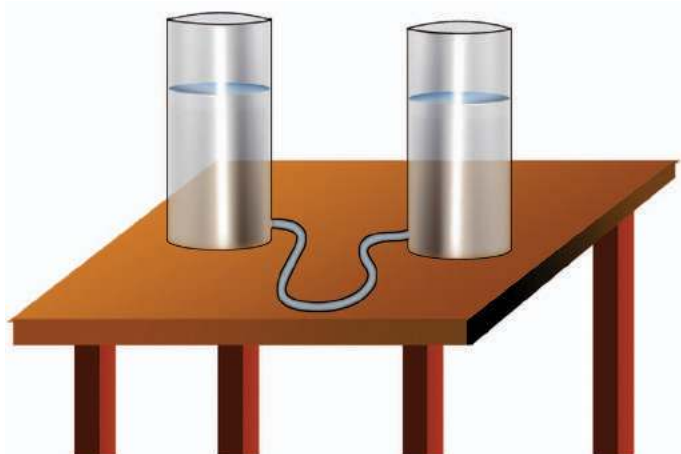

of a mason pipe into each of the holes closing them, without leakage, using an adhesive. Add water to fill one bottle completely. What do you observe? Are the water levels in the two bottles the same?

Remove some water from one of the bottles. Does the water level of the other bottle change now?

What is the change observed in the level of water when some sand is put into one of the bottles? Now remove the sand in small quantities using a spoon. Observe the change in water level. Does the water level fall?

Water maintains its level

When ground water is collected in large quantities for industrial and commercial purposes, it results in the depletion of water level. This leads to the fall of water level in wells in the neighbourhood.

Repeat this experiment after connecting four or five bottles together.

Substances that sink and those which float

Mubashira is experimenting by putting a block of wood in water. You can see the block of wood floating. Do all substances float on water like this?

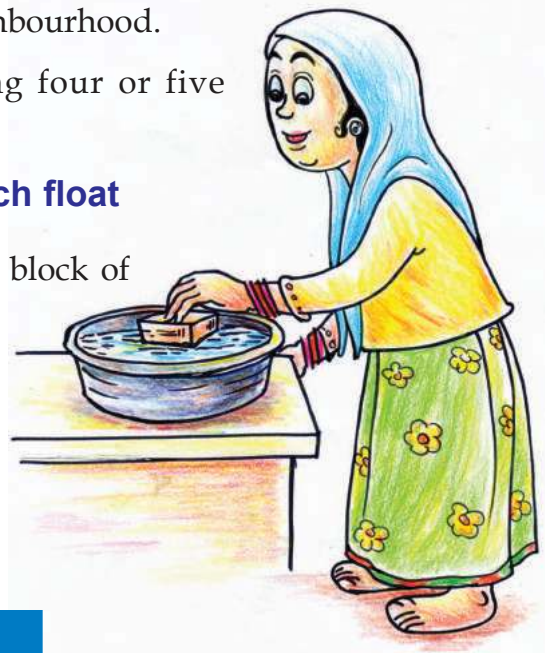

Try the experiment putting some familiar objects in water. Write your observations in the science diary.

Objects that float on water	Objects that sink in water

You have now understood that several objects float on water. Have you come across any instance in which we make use of this property?

- Learning to swim holding on to a plantain stem.
- Carrying articles on a raft.

How to measure?

Don't you buy kerosene from the ration shop? Do you buy it weighed or measured? Haven't you noticed measuring vessels there? What is the unit for measuring liquids?

Litre is the unit used for measuring liquids.

When small quantities of liquids are to be measured the unit is millilitre.

Let us make a one litre vessel using chart paper. For this, we should make a box with length, breadth and height 10 cm each.

Cut the chart paper as shown, fold it along the dotted lines and paste it. The litre vessel is ready.

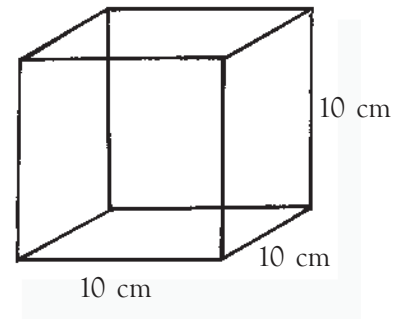
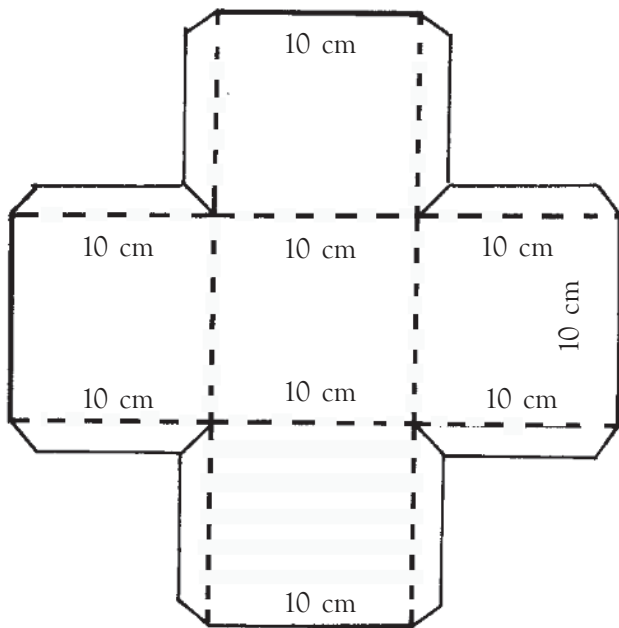
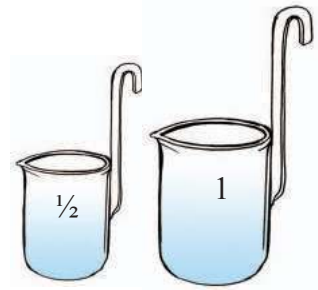

Let us find the inner measurements of this vessel.

$$10 \text{ cm} \times 10 \text{ cm} \times 10 \text{ cm} = 1000 \text{ cubic centimetre}$$

That is

$$1000 \text{ cubic centimetre} = 1 \text{ litre}$$

One cubic centimetre can also be called one millilitre

$$\text{Therefore one litre} = 1000 \text{ millilitre}$$

We use bottles and vessels of different capacities everyday. Can you measure out $\frac{1}{2}$ litre, 1 litre, 2 litre and 5 litre water using these? Try and note down your inferences in the science diary.

The Earth abundant in water, still...

Look at the globe. The blue colour shows water bodies. Most of the portion of the earth is ocean. Two third of the surface area of the earth is water, which is double the area of land.

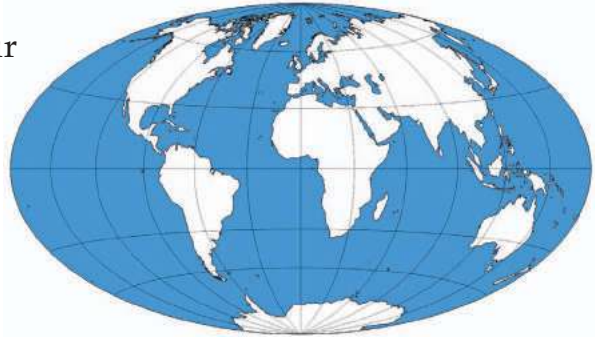

Major portion of water in the earth is sea water

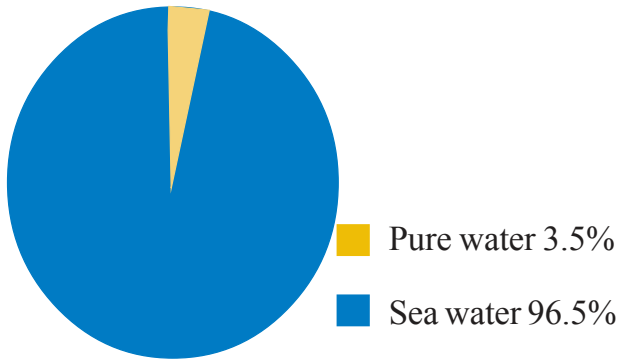

The amount of salt in sea water is high. Hence it cannot be used for common purposes. It is the water from pure water sources such as wells, ponds, lakes and rivers that we can use.

What are the sources of water in and around your house? List them in your science diary. Do we get water from these sources at all times?

Water pollution

We know that even water from the limited pure water sources is getting polluted.



Let us find the different ways in which water gets polluted and record them in your science diary.

If the following are present in your findings, tick (✓) them.

- Washing vehicles and bathing cattle in the river
- Throwing plastic wastes into water sources
- Dumping waste materials from fish and meat markets
- Dumping waste from factories
- Spraying pesticides in agricultural fields.

Discuss with friends the possible methods to prevent water pollution. You can implement them under the auspices of the science club.

When do our water bodies become abundant in water?

How is rain formed?

What happens to the water in the water bodies when it receives heat from the sun? Let us perform an experiment. Let it be in the kitchen itself.

Heat some water in a vessel. Cover it with a plate. After some time examine the inner side of the plate. Write down your observations in the science diary. The illustration given below will help you to explain, on the basis of this experiment, how rain is formed.

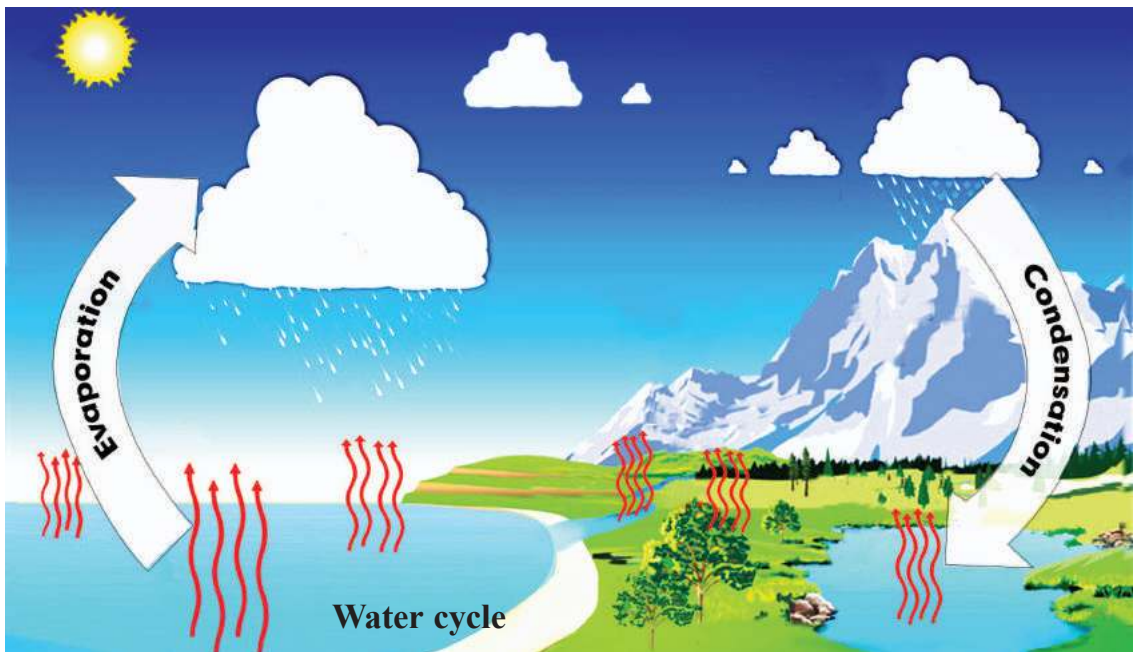

The water from water bodies and plants reach the atmosphere in the form of water vapour due to the heat of the sun. The water vapour condenses in the form of clouds, gets cooled and comes down as rain.

*The water you
drink today is the
water with which you
once had your bath...
Ha... Ha... Ha*



Evaporation and Condensation

Evaporation is the process by which liquids change to vapour due to heat. On cooling, vapour changes to liquid and this is called condensation. Water changing into water vapour is an example of evaporation and water vapour changing into water is an example of condensation.

Water conservation methods

Shouldn't the water reaching the soil in the form of rain be used in future also?

What are the methods to be adopted to allow rain water sink into the soil?

Observe the pictures and note down the findings in the science diary.



Rain harvesting pit



Mud walls



Sloping land cut into different layers



Preparing basins around trees



Rain water storage tank



Rain water into wells



Silpaulin water storage tank

Rainwater storage tank, silpaulin water storage tank and well recharging are some of the new methods prevailing today. With the help of your teacher you can view related CDs and write down a note in the science diary about the various methods of conserving water. Which of them are most suitable to your place?

Arrange a seminar in the class on the topic "Importance of water and the methods of its storage and conservation."

When water turns a villain

Doesn't water which is so essential for life also become a destroyer at times? Do you have such experiences?

Read Ammu's diary note.

11
JULY

It has been raining heavily since morning. Not the gentle rain seen till yesterday, but heavy downpour in all its fury. Strong winds at times, blowing as if to frighten. The mango tree lay uprooted. When the rain subsided a little, I went with my father to Arathi's house. Water had entered her house.

The wall on the southern part of the house had collapsed. I felt very sad when I saw Arathi and her mother standing helplessly knee-deep in water. When my father asked them to stay with us in our house till the rain subsided, I felt like hugging and kissing him since I also wanted to suggest the same to him.

If Ammu's father had not helped Arathi and her mother, how miserable it would have been!

You also might have seen disasters caused by rain. You might have come to know such things from the news through media such as the radio, newspaper, television and so on. Conduct a discussion on such news in the class. The points mentioned below should be included.

- Floods
- Landslide
- Uprooting of trees
- Sea turbulence
- Destruction of agriculture
- Soil erosion
- Mudslide
- Destruction of houses and buildings
- Diseases of rainy season

Collect news items related to monsoon disasters from the newspapers and prepare a magazine.

What preventive steps can we take to avoid death by drowning?

River in fury : Death by drowning repeated

Kuttippuram : Death by drowning has become a continuous story at Mallur Jetty near Kuttippuram Bridge. Local people say that the river flowing in fury, on reaching this area forms a death trap. A devotee from Karnataka was drowned to death here yesterday. He had reached here with a group of thirty devotees from Mangalore.

- Everybody may be given training in swimming. Plantain stems which float on water or inflated tubes of four wheelers can be used for this.
- Services of water divers and life guards should be made available, safety boats and first aid facilities are to be provided and safety measures in water transport vehicles should be ensured at such accident prone areas.

When water bodies and agricultural fields are filled with mud and river banks are encroached for building purposes, the flow of water gets blocked. Floods occur as a natural consequence in such places.

Deaths by drowning that are common in the rainy season are mostly caused



Floods





Landslide



Sea turbulence

by unsafe water- logged areas. The unscientific construction work in steep places, the cultivation methods with large scale soil digging, the levelling of hills and deforestation lead to landslides.

Even though not man-made, sea turbulence also causes great destruction and loss. The intensity of loss by accidents is further increased when people ignore warnings and live close to the sea shore. Coastal erosion can be controlled by constructing sea walls and raising mangroves.

List in the science diary the methods to prevent natural disasters.

Natural disasters	Methods of prevention and control
Floods	
Mudslide	
Landslide	
Drowning	
Coastal erosion	

Collect maximum information about voluntary organizations and their volunteers in your area. Invite such philanthropic voluntary workers to your school and honour them.

Willing to serve ...

Have you ever thought of the people who participate in rescue operations during natural calamities like floods, landslide, tsunami and so on even at the risk of their lives? We should view with respect such voluntary activists. Voluntary organizations like the Red Cross, operate in this field. Scouts and Guides, NCC, Junior Red Cross etc are organizations in which service-minded students can work. Won't you enroll in such voluntary organizations? How great it is to help others!





Significant learning outcomes

The learner can

- identify properties of water that enable it for various uses and explain and tabulate.
- identify and explain that the ability of water to dissolve many substances is beneficial to us.
- give examples for situations in which we make use of the property of certain materials to float on water.
- define and distinguish between solute, solvent and solution.
- realise and explain that the availability of pure water in the earth is limited.
- identify situations which lead to the pollution of sources of pure water in the neighbourhood and suggest water conservation methods and put them into practice.
- illustrate water cycle and explain how it is useful to living beings.
- suggest precautions to prevent monsoon disasters.
- perform experiments related to the properties of water carefully and accurately.
- design experiments and construct apparatus related to the concept that water maintains its level.



Let us assess

1. Among the various properties of water, which are applicable to the following situations?
 - i. Water shortage due to excessive sand mining in rivers.
 - ii. The water shortage caused in nearby wells due to the exploitation of water from a well rich in water.
2. The gum which sticks to the knife while cutting a jack fruit is removed using kerosene. Which property of kerosene is utilised here?

3. We have discussed various methods of disaster management and prevention. Find out a few methods to escape from natural calamities which are a threat to your place. Compile the information collected and prepare a notice for the attention of the local population.
4. Complete the following illustration related to water.

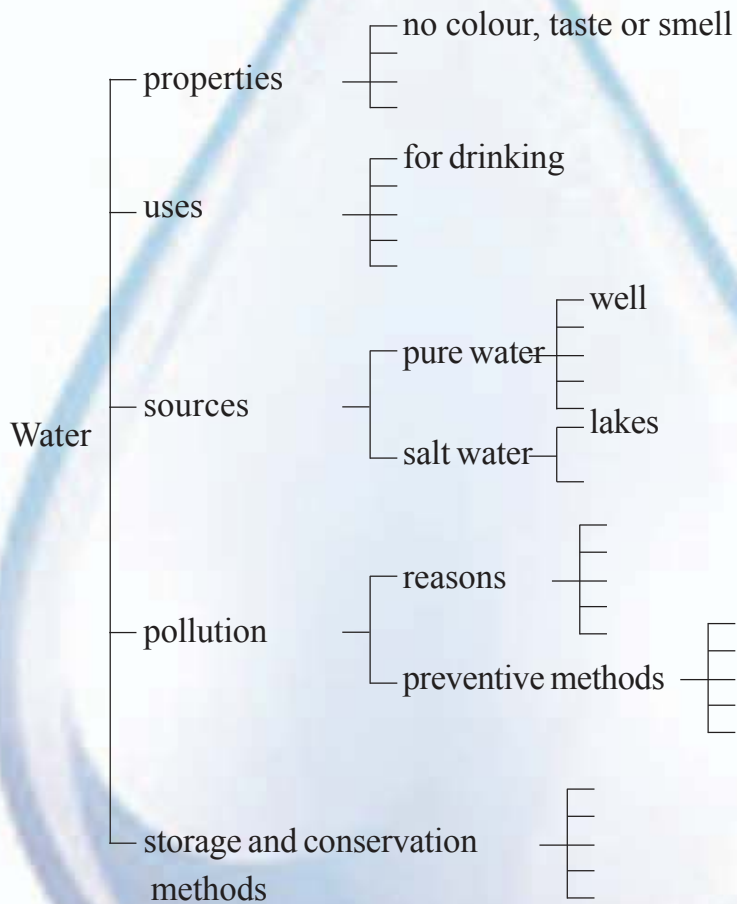



Extended activities

1. Heat some powdered blue vitriol in a vessel. Does its blue colour disappear? Add a drop of water into this and observe the change.
2. We know that water is a universal solvent. What suggestions can be made to increase the rate of solubility of water-soluble substances? Conduct experiments based on your suggestions.
3. The drilling of a large number of tube wells to draw excess amount of water causes water depletion in other wells. Prepare a notice giving a scientific explanation for this.
4. We have learned to make a litre vessel. If the height alone of this litre vessel is reduced to 5 cm, the water it can contain also reduces to half (500 millilitre). Using a discarded vessel in your house you can design a device to measure out quantities such as 500 millilitre, 1 litre and 2 litre of any liquid.





3

Celestial Shadow Sights

We live in a world filled with light. Imagine a world without light. How difficult it would be if we cannot see the objects around us!

Light is essential to see objects. How many are the wonderful sights around us! The enamouring beauty of nature, the colourful sunrise and sunset, the seven-tinged rainbow and so on - can we see them if there is no light?



Who is not fascinated by the pleasant morning sight of sunrays filtering through leaves?

Haven't you seen light straining through the gap between tiles in a smoke-filled kitchen?



How does the path of light appear when a torch is lit at night?

Why does the light from a vehicle move off the road when the vehicle turns a curve?

Were you able to identify any peculiarity of light in these situations?

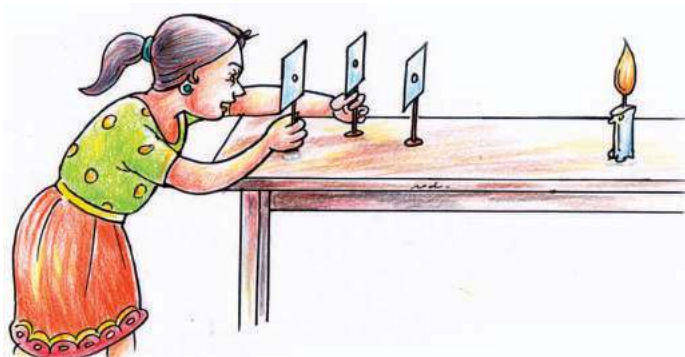

Ammu is trying to view the light emitted by a burning candle kept at a distance by arranging three cards.

What are the things to be taken care of to make this possible?

Let's try to do Ammu's experiment.

Make holes in three thick cardboards as shown in the figure. Arrange them in such a way that the flame of the burning candle is visible through the holes.

In which arrangement of cards is it possible for you to see the flame?

Why are you unable to see the flame when the position of the middle cardboard is changed slightly? Have you noticed that the flame cannot be seen even if there is only the slightest shift in the position of any of the three cardboards?

Record the findings of this experiment in your science diary.

There are many such instances that prove that light travels in a straight line. Aren't you curious to know more about light?

Substances which allow light to pass through and those which do not

Does light pass through all substances? Let us find out.

Materials required: Glass sheet, metal vessel, oil paper, ground glass, cardboard, block of wood, ball and torch.

Direct the torch light onto a wall. Observe the changes when different objects are introduced into the path of light.

Record your observations in the science diary. The different materials may be classified on the basis of the transmission of light through them.

Does light pass through all objects? Aren't there objects which do not permit light to pass through them and those which do it only partially?

Objects which allow light to pass through them completely are transparent objects.

Objects which do not allow light to pass through them are opaque objects.

Objects which allow light to pass through them partially are translucent objects.

Classify familiar substances into transparent and opaque substances and tabulate them in the science diary.

The following indicators will help you to find the maximum number of such substances :

- Are all solid substances opaque?
- Aren't there transparent liquids?
- Aren't there opaque liquids?
- Aren't there translucent liquids?
- Aren't gases generally transparent?



You know that water is a transparent liquid. Can you make water opaque? How? Write down your suggestions in the science diary.

How do we make use of the transparency and opacity of objects in daily life? You may conduct a seminar based on this subject. Consider the indicators given below.

- If air, glass pieces etc. were opaque....
- If all solid substances were transparent....
- The use and need of opaque substances in daily life.

Shadows

We have understood the use of opaque objects in our daily life.

Opaque objects can cast shadows. Let's look at some games based on this fact.

Making shadow figures

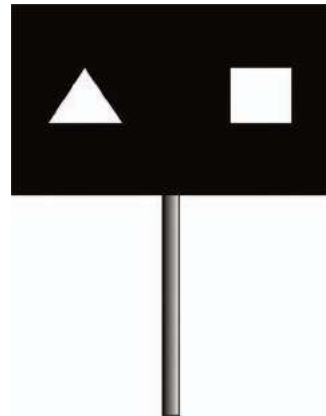
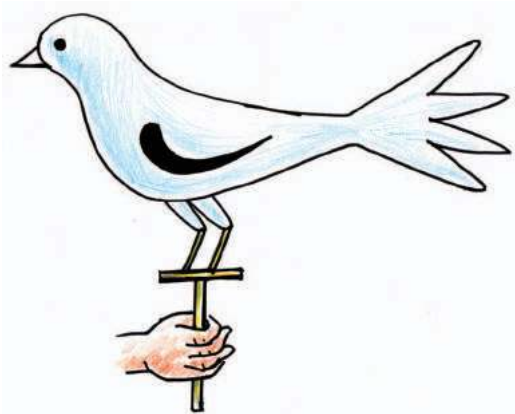

Let us see how to make shadow figures. Cut the shapes carefully from a cardboard as shown in the figure. Each shape need only be one fourth the size of a post card. Prepare a handle by fixing a thin stick on to the shapes.

Hold this card near a wall and direct light from a powerful torch onto it. Observe the shadow patterns seen on the wall. Move the card closer to the torch. Do you see any changes in the shadow? How do the size and the clarity of the shadow change when the card is moved further away from the wall?

Did you like the experiment using shadow pictures?

We have carried out this activity only by making use of light and shadow. Look at the shadow pictures formed when you hold your fingers in different ways in the path of light. By practising this with your friends, you will be able to master the technique easily. You can make more shadow pictures by experimenting yourself. What about arranging a show using such shadow pictures?

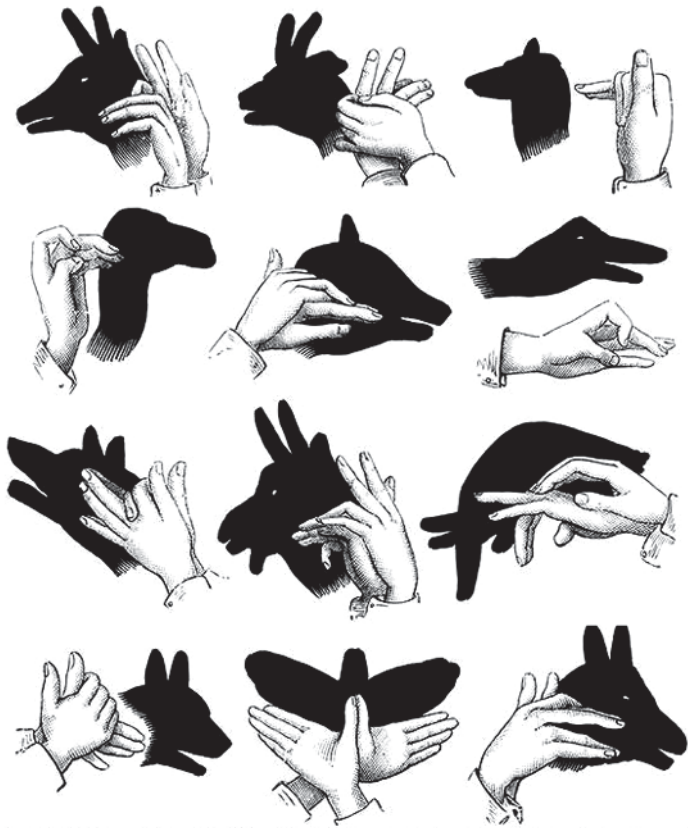

shadow puppetry

Make beautiful cut-outs using your imagination and organize a group wise show in your class.

Have you heard of shadow puppetry? It is a visual art making use of shadows.

Celestial spheres too have shadows

Sun

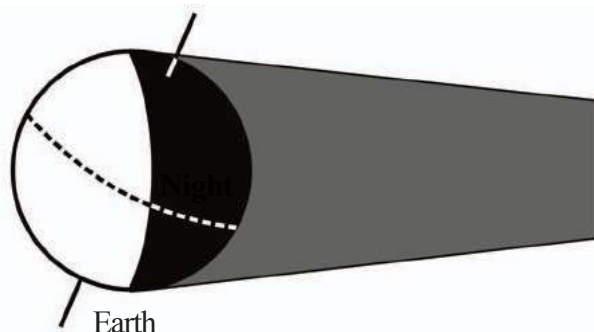

Earth

Look at the figure and observe how sunlight falls on the earth. We know that it is daytime where the light falls.

Then, what do you think is night?

The side opposite to the portion where light falls appears dark because the earth is opaque. For the same reason, it is dark at night since earth, being opaque, obstructs light.

You already know that opaque objects can form shadows. What if the earth were transparent?

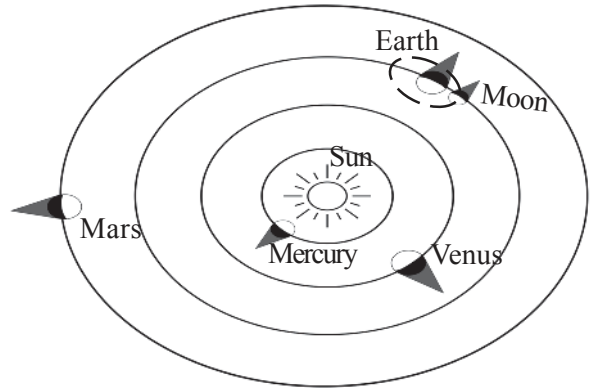
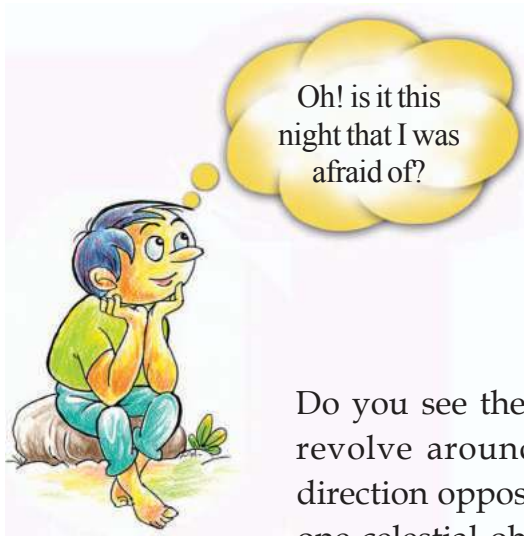

Do you see the shadowy paths of celestial spheres that revolve around the sun? They will always be in the direction opposite to the sun. Rarely does the shadow of one celestial object fall on another.

Solar eclipse

When the moon comes between the earth and the sun in a straight line, the earth comes in the shadow of the moon. Then the shadow of the moon falls on the earth. The sun cannot be seen from the area where the shadow falls. This is solar eclipse. Observe the figure.

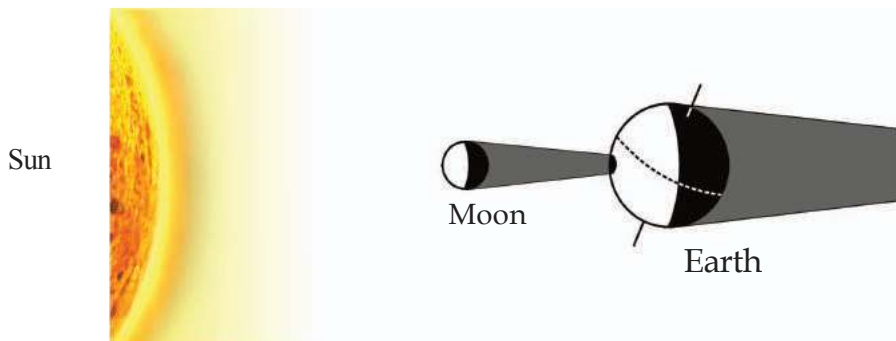

- Does the shadow of the moon cover half the earth?
- From which position of earth does it appear to you that the moon blocks the sun?

- Is it at night or during day that the solar eclipse becomes visible?

Demonstrate the solar eclipse in the class using balls of different sizes and a source that emits parallel rays of light.

Lunar eclipse

We have seen how the solar eclipse occurs. What happens when the earth comes between the sun and the moon in a straight line? The moon then comes in the shadow of the earth and will be invisible. This is lunar eclipse.

Look at the figure...

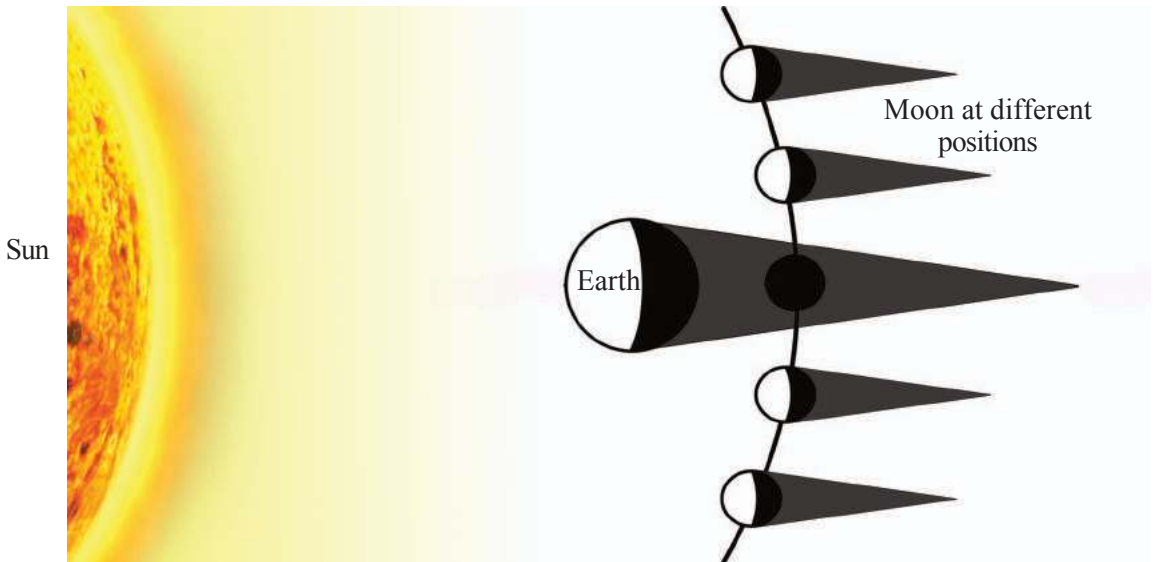

- Does the lunar eclipse occur at night or during day?
- Identify the positions of the earth, the sun and the moon during the lunar eclipse.



Watch video visuals of the solar and lunar eclipses. There are provisions to see past eclipses and future eclipses in Edubuntu. The software K- Star will help you in this regard.

Different types of solar eclipses

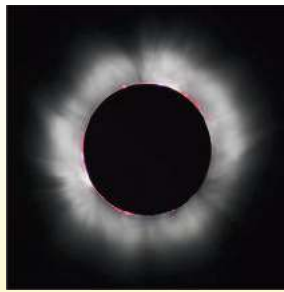

Total solar eclipse

Solar eclipses visible in



Ring solar eclipse



Partial solar eclipse

Do you agree with the following statements?

1. Transparent objects do not cast shadows
2. Celestial spheres like the earth and the moon are opaque.
3. The shadow of the earth falls on the moon during lunar eclipse.
4. Solar eclipse takes place when the shadow of the moon falls on the earth.

Now that we know what eclipses are, should we fear these celestial shadow sights any more?

How many eclipses might be occurring in other celestial spheres too, other than the earth!

Observing the Eclipse

The shadow of the earth falling on the full moon during a lunar eclipse presents a beautiful sight. Try to see the celestial sight of the moon hiding in the shadow of the earth.



Solar eclipse-Safe observation methods

However, see that you observe the solar eclipse only with effective safety precautions. It should be viewed only by using solar filters or using the reflection or the transmission method.

Viewing a solar eclipse without safety precautions can damage the eye. Do not look at the sun using telescope or binoculars. Make sure to view the solar eclipse under the supervision of elders.



Significant learning outcomes

The learner can

- explain that light travels in a straight line.
- classify objects into transparent, opaque and translucent.
- identify and explain uses of opaque and transparent objects.
- explain how solar and lunar eclipses occur and explain the positions of the earth, the moon and the sun during eclipses.
- identify and create an awareness that an eclipse is a natural phenomenon and that eclipses need not be viewed with fear.
- help others view a solar eclipse using safety measures.
- plan and do experiments related to eclipses.



Let us assess

1. Gracy and Mujeeb are trying to observe the flame of a burning candle through pipes. Who will be able to view the flame? Why?

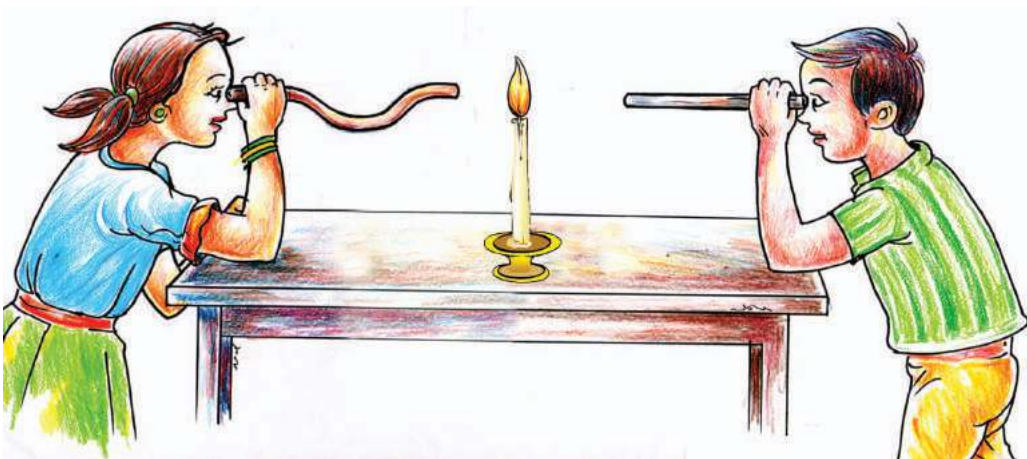

- Classify the following objects into those that cast shadows and those which do not. Explain why.

Glass paper, cardboard, wooden plank, glass sheet, tiles, air

- What will be the positions of the earth, the sun and the moon during solar and lunar eclipses? Draw a diagram.
- Deepu is of the opinion that solar and lunar eclipses occur because the earth and the moon are opaque. Do you agree with this? Explain.
- “Viewing an eclipse is dangerous”** This is the title of a news item in a newspaper regarding an eclipse. Which eclipse is this news related to? Can you suggest ways to view the eclipse safely?



Extended activities

- Make a toy binocular, using two wiring pipes of approximately 10 cm length and two thermocol pieces, as shown in the figure.

The principle behind the functioning of a binocular is that light from the objects you look at, travels in a straight line through the pipe to reach your eye. While narrow pipes are used to watch distant objects, pipes that have a little more area of cross section are needed to watch nearby objects.

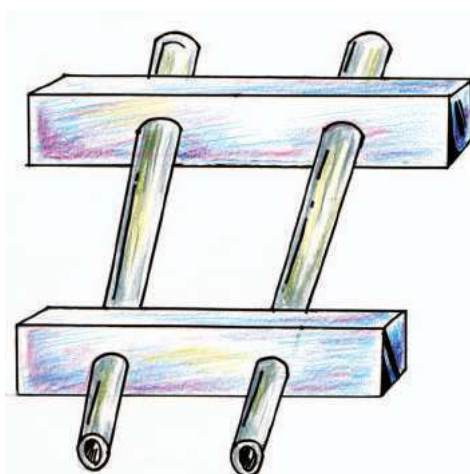

Model of a binocular

- Isn't it because some refills and pens are transparent that you recognize the level of ink in them? Find out more devices which make use of transparent objects.
- Collect news regarding past eclipses and compile an Eclipse Magazine.

4) Let's make a 'shadow box'.

Materials required

- a torch emitting parallel rays of light.
- a cardboard box
- a small ball fixed on a stand
- Oil paper
- Glass paper
- Glue

How to make:

Make a hole on one side of a cardboard box with size less than that of a torch head. Cut a square portion from the other side of the box and fix

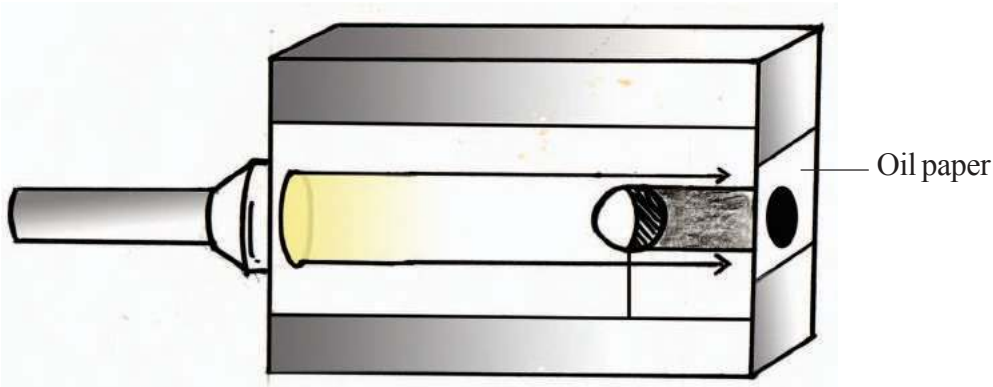

the oil paper there. Now cut apart an approximately big rectangular piece so that the inside of the box can be seen, as shown in the figure, and fix the glass paper there. Place the ball fixed on the stand inside the box as shown in the figure.

Now pass the torch light through the hole on one side of the box in a dark room. Are you able to see the shadow of the ball which obstructs the path of light, on the oil paper? Repeat the experiment using balls of different sizes.



4

Life within the Seed

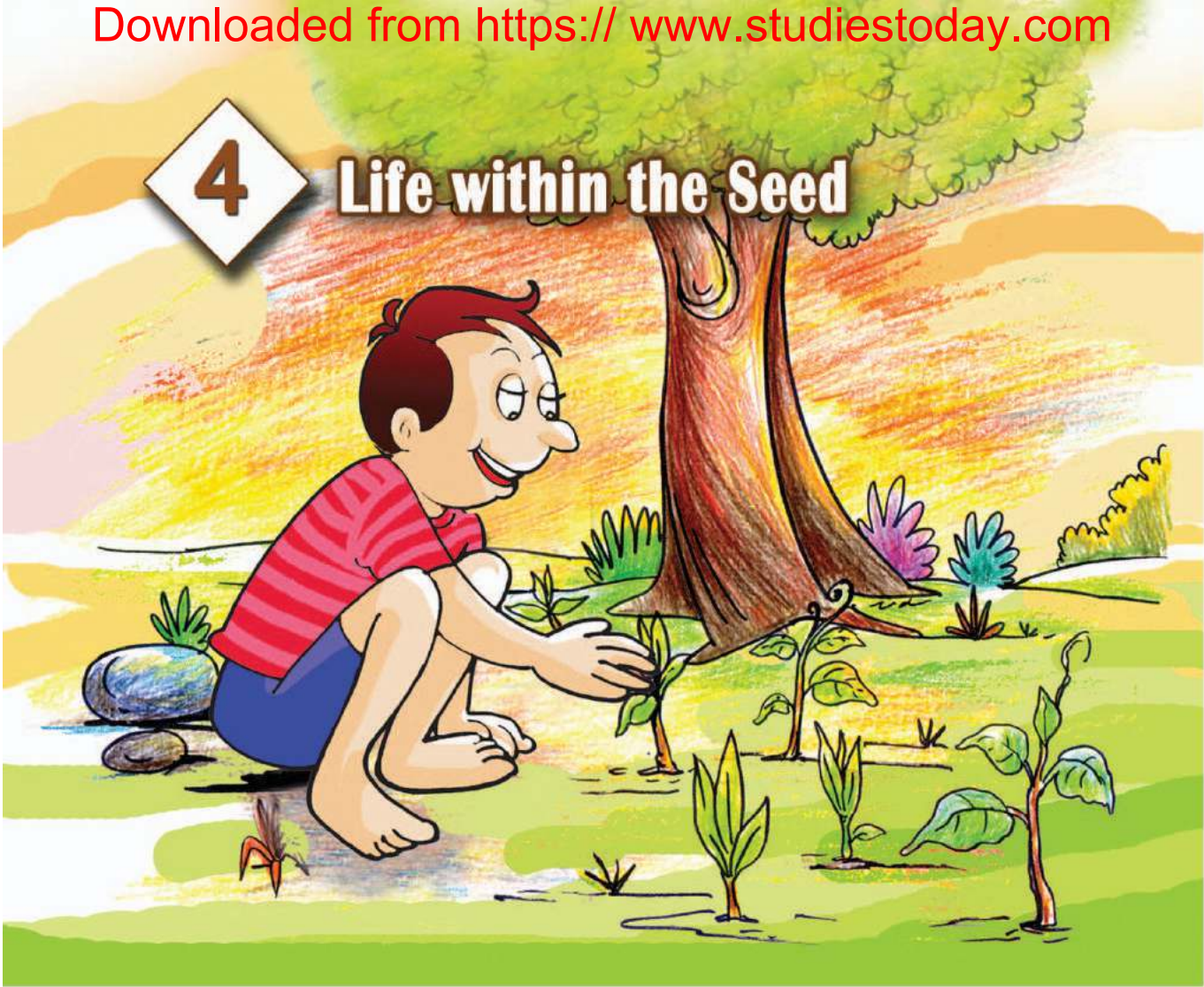

The whole yard was parched. But just after two days of rain, grass has sprouted everywhere. Tender leaves started appearing on the hibiscus stem thrown into the basin of the coconut tree by Papa. Tried to uproot one or two grass. They have roots. Do they form by the sprouting of seeds? Nothing is seen.

Should tell Papa to buy me a lens to see them enlarged. Here and there tamarind seeds have sprouted. How smartly the sprouts have come out splitting the seed! Moreover this has also brought up parts of the seed out of the soil. Oh... what a pity that I didn't know that so many wonders lay hidden in my yard!

(From Aneesh's diary)

Did you read Aneesh's diary?

What do seeds require to germinate?

Let us listen to what the sprouted seeds in our yard have to say.

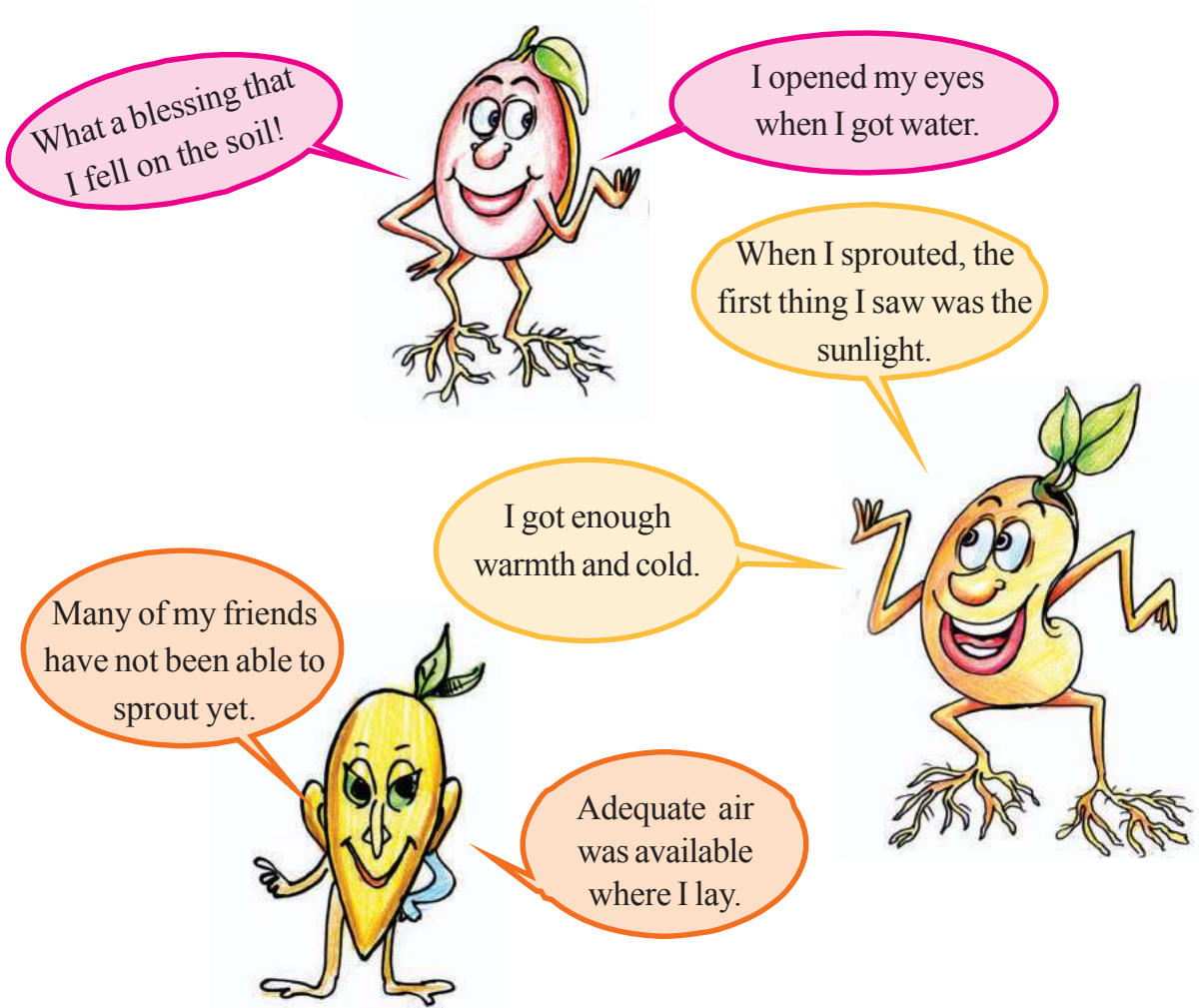

What does a seed need to germinate? Your guesses may be noted down in your science diary. Let us find out through an experiment the requirements for the germination of seeds.

Is soil required for the germination of seeds?

In order to test whether soil is required for sprouting, the seeds meant for sprouting should be kept away from soil. But they should get water, air and atmospheric temperature. Let us do an experiment.

Materials required:

Disposable glass, pea seeds, cotton, water

Procedure:

- Put small holes at the bottom of the disposable glass.
- Take some cotton in the glass and put four or five pea seeds.
- Pour some water in the cotton.
- Keep the glass open in sunlight.

Record your observations daily.

Do the seeds lying in the cotton sprout?

What conclusion did you arrive at from this experiment?

Write down the experiment note.

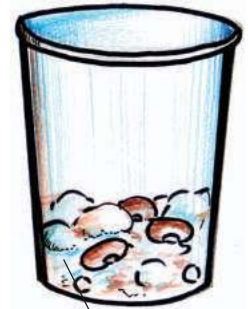

cotton

Is water required for the germination of seeds?

This experiment is done to see whether water is needed for seed germination.

What are the factors that should be made available and what are those that should be controlled?

Let's try this way...

Fill a disposable glass with completely dry soil. Put four or five pea seeds in it. The seeds should get normal air, light and atmospheric temperature.

Points to remember

- Soil should not contain any trace of water.
- During the rainy season, air contains moisture. The seed should not be exposed to it.
- The glass used for the experiment should not contain any trace of water.
- The glass should not be placed where rain falls.

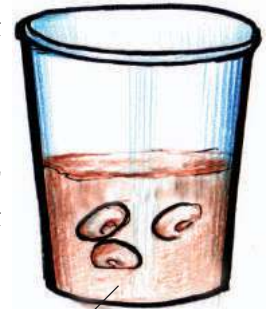

soil

Complete the experiment and write down the experiment note in your science diary.

Is sunlight necessary for the germination of seeds?

Put some soil in a disposable glass having holes at its base.

After putting some pea seeds, pour some water.

Place the glass in a cardboard box and cover it in such a way that sunlight never enters it.

What did you find out from this experiment?

Write the experiment note in the science diary.

For seeds to germinate

Air, water and favourable temperature are essential for the germination of seeds. Sunlight and soil are required for growth after sprouting.



See (Edubuntu, School Resource) video on '*vithumulakkal*'.

Classify the following factors into those that are required and those that are not required for the sprouting of seeds, and note them down in the science diary.

- Air
- Water
- Sunlight
- Favourable temperature
- Manure
- Soil



Making paddy seeds sprout

Look at the method used by farmers to sprout paddy seedlings for the monsoon harvest in Kerala.

A bed is created in the courtyard using plantain stems. Cycas leaves are spread on it and the paddy seeds chosen for sprouting are spread on it. After pressing the seeds in the bed properly with a wooden plank, cycas strips are again spread over it. Heavy objects are placed over this. This is done for obtaining a moderate temperature, which is required for the sprouting of seeds. Continue watering for 4-5 days. The seeds sprout and mature.



In some places the practice of keeping paddy seeds in sacks and sprouting them by placing heavy objects over the sacks also prevails.

You have observed the sprouting of seeds.
Isn't food also required for growth?
They don't have leaves to prepare food.
From where do they get food?
Read the following note.

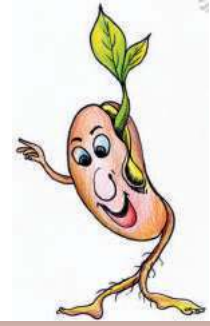

Germination of Seeds

Germination is the process of the embryo inside the seed growing into a seedling under favourable circumstances. Water enters the seed through the minute pores in the seed. The seed soaks and the outer coat breaks. The embryo inside the seed also respire.

During germination, radicle is the first to come out. Radicle grows into the soil and forms root. The plumule is the portion that grows upwards from the embryo. The plumule grows into stem. The germinating seed uses the food of the cotyledon until the leaves grow enough to synthesise food.

Open the seeds of pea, bengalgram etc. and observe the cotyledon.

Various steps in the germination of pea seed

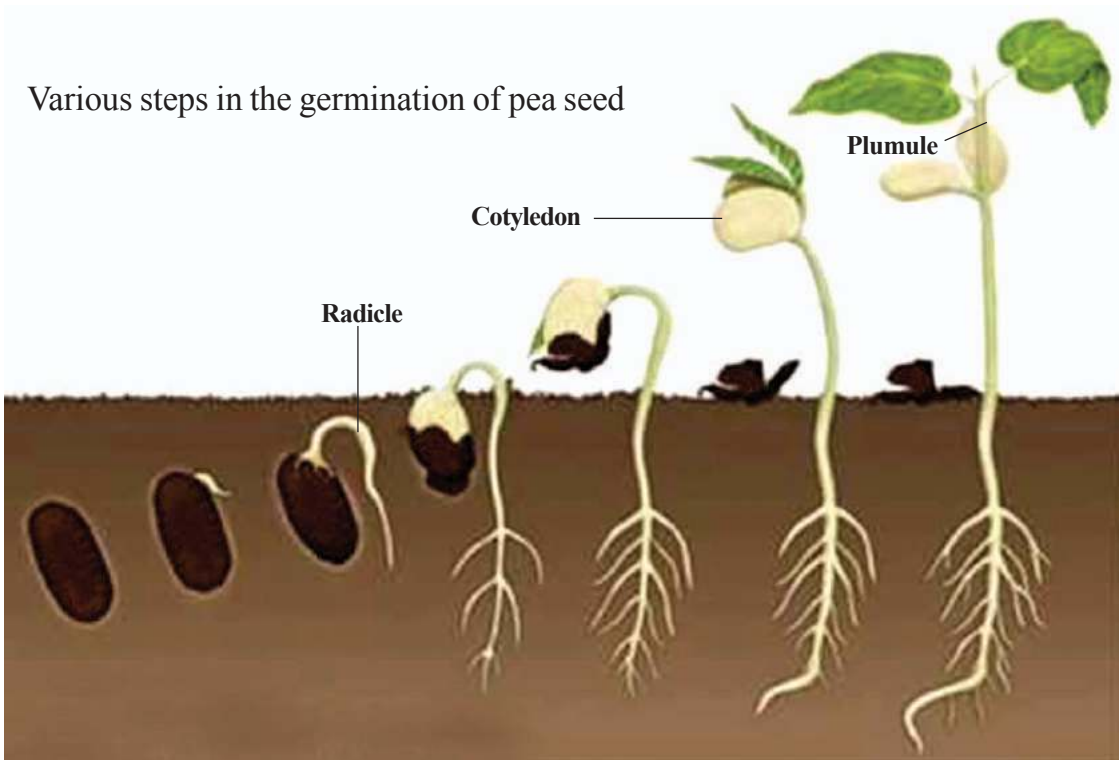

Have you seen the tamarind seed, cashew nut, jackfruit seed etc sprouting?

Observe the radicle, plumule etc. Which portion of the sprouting seed comes out first?



You may see the 'Vithumulakkal' scenes available on the video (Edubuntu - School resource).

We have seen that pea plant germinates from seeds. Are seeds the planting material for all plants?

Look at Anaswara's garden. Are all plants formed in the same way? Discuss on the basis of indicators given below.



- Are plantlets formed from seeds in all plants?
- Aren't there plants which produce new ones from other parts of the plant?

Classify the different plants seen around you on the basis of mode of formation of plantlets.

Seed	Stem	Leaves	Root
Chrysanthemum (Mallika)	Crape Jasmine (Nanthyarvattom)	Bryophyllum (Ilamulachi)	Sandalwood tree (Chandanam)

Vegetative propagation

Vegetative propagation is the formation of new plants from vegetative parts of plants like root, stem and leaf.



Listen to the conversation between the pappus and the girl.

Girl : Why do you fly like this, dear pappus?

Pappus : I am flying in search of a favourable place for my seed to grow.

Girl : Which is your seed?

Pappus : This little thing I hold is my seed. Many of my friends are flying like this with a seed at different places.

Girl : Why do you and your friends suffer like this? Can't you fall at the base of your own tree and germinate there?

Pappus : We were born on a climber. If the ripe fruits burst and we fell and grew there itself, we wouldn't get enough water, manure and sunlight to grow. Since our seeds are light and have hairy parts, we can fly freely in air. Many plants adopt various tricks like this to disperse their seeds to distant places.

How does seed dispersal take place in pappus? What are the peculiarities that help pappus to fly freely in the wind? Are the seeds of all plants dispersed through wind?

Haven't we seen the guava, cashew fruit, mango etc., carried by birds to our places? Isn't the fleshy part of these fruits eaten by birds? Their seeds are also seen sprouting on the ground. Similarly seeds dispersed in different ways have different types of adaptations.

Dispersal of seeds

If all the seeds of a plant germinate at the base of the plant itself, they may not get sufficient soil, water, sunlight or mineral salts for their growth. Hence seeds are to be dispersed to different places. This enables a plant to reach and grow in different places. The presence of different plants at one place is also due to seed dispersal.

Seeds dispersed through water and by bursting

Seeds get dispersed. Seeds exhibit many peculiarities to get them dispersed. Look at the pictures.

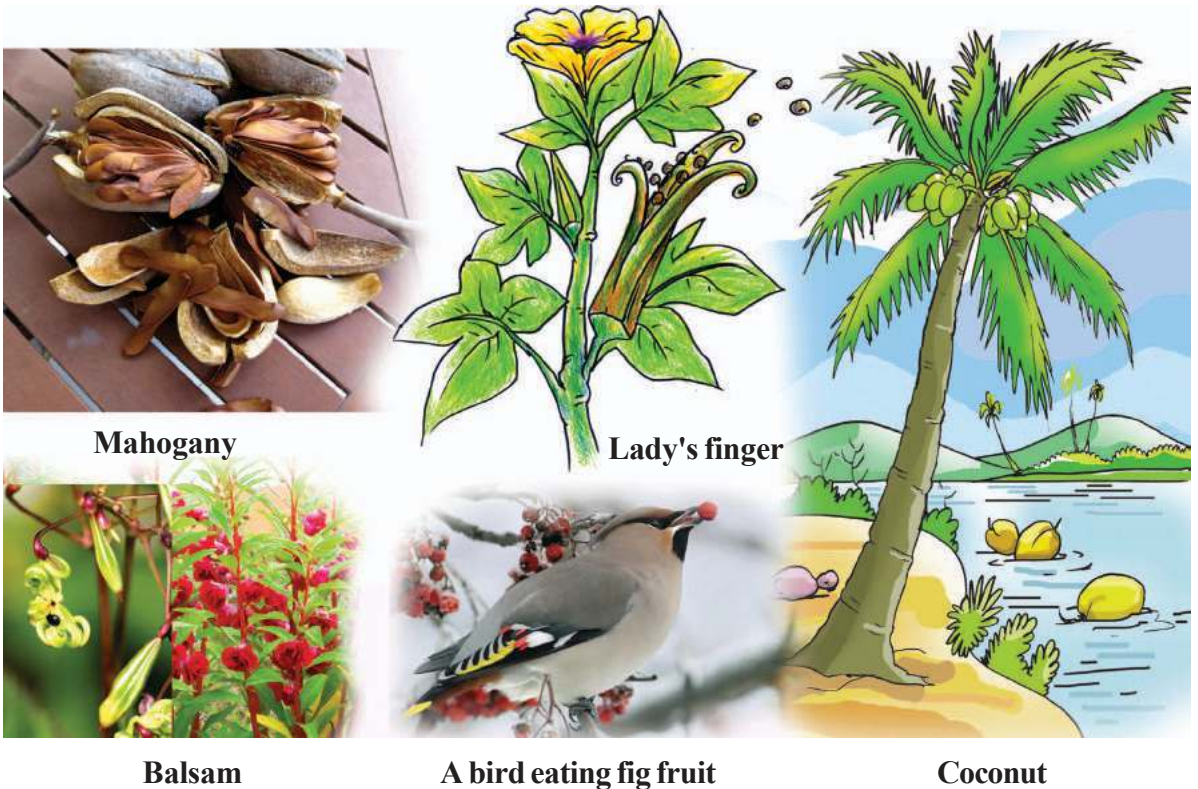

Mahogany

Lady's finger

Balsam

A bird eating fig fruit

Coconut

- Does the dispersal of seed take place in the same manner in mahogany and balsam?
- What are the peculiarities that help a coconut to flow through water?

Adaptations for seed dispersal

Haven't you seen birds picking fruit and flying with them? It is the edible fleshy part that attracts birds and animals. Seeds with fleshy parts are dispersed in this way. It is seed dispersal that takes place when you throw away the mango seed.

But all fruits do not have fleshy parts. See the dispersal techniques of some seeds.

- Hooks to stick on to bodies of animals.
- Gum
- Pointed tips

Have you noticed seeds clinging on the body of grazing cows?



Haven't you observed grass seeds sticking to your clothes when you play amidst grass?

Do you remember the pappus and what it said?

Seeds that fly in wind are lighter.

They have a part that helps them fly.

What peculiarities do seeds that are dispersed through water have?

- They can float on water.
- They don't decay even when they are in water for a few days.

Seeds fall at distant places when the fruits of lady's finger, balsam etc. burst.

There are plants around us which disperse their seeds in different ways. Classify them on the basis of the mode of dispersal of their seeds and tabulate them in the science diary. Find and add more examples to each category.

Mode of seed dispersal	Plants	Adaptations
Through wind	Pappus	Light seed Hair like parts to fly
	Mahogany	
Through water	Coconut	
Through animals	Ficus, Jack tree Guava tree, Arrow grass	
By bursting	Lady's finger, Balsam	

Prepare a project report after finding out the mode of seed dispersal, adaptations etc. of various plants.

Guests from across the sea

Man also has a role in the dispersal of seeds. Since ancient times, we have been carrying seeds with us to and fro during our travel to other countries and distant places. They are thus dispersed to different places and grow there. Pineapple, tea, tapioca, papaya, rubber, cashew nut etc. came to India from foreign countries in this manner.



Agricultural crops	Place of origin
Pineapple, Tapioca, Tomato, Potato, Green chilly, Guava, Papaya, Coffee	America
Tea	China
Cabbage	Europe
Rubber, Cashew tree	Brazil

Many plants have been brought from foreign countries and grown here. How have they enriched our agricultural sector? Discuss and note down in your science diary.

We used to bring seeds even from other countries and cultivate here. Today it is seen that we depend on other states for many of our food items.

Don't you think it is better if we ourselves can cultivate and produce at least a portion of the food items we need?

If we do this, what are the benefits we will have?

- Dishes with better vegetables.
- Knowledge about different stages of vegetable cultivation.
- Pesticide-free vegetables.
- Employment opportunities and financial gains.

What are the factors to be taken care of while making a vegetable garden?

- Seeds should be of high quality.
- Soil should be fertile and should have good drainage.
- Sunlight should be adequate.
- Sufficient water should be made available.
- Proper manuring, pest control, weed control etc. should be taken care of.

Remember to record in your science diary the activities you carried out while making a vegetable garden and the various stages of farming.



Significant learning outcomes

The learner can

- explain the necessity of air, water and favourable temperature for the germination of seeds.
- explain the changes a seed undergoes during germination.
- conduct experiments by controlling the variables to find out the factors necessary for the germination of seeds.
- classify plants on the basis of the type of vegetative propagation.
- identify and explain the importance, methods and adaptations of seed dispersal.
- realise the need to cultivate at least some of the vegetables that we use and set up a vegetable garden.



Let us assess

1. You might have seen ficus seedlings sprouting from some buildings. How could have the ficus seed reached there?
2. Ramesh said that the seed of lady's finger, if sown too deep, will not sprout. Do you agree with this opinion? Why?
3. Find out whether the given statements are true or false.
 - i. Plants without seeds also propagate .
 - ii. Only seeds that reach the soil will sprout.
 - iii. Man also facilitates seed dispersal.
 - iv. When a seed germinates the part that comes out first is the root.
 - v. Seeds dispersed through wind will have fleshy parts.
 - vi. Sunlight is not essential for seed germination.
4. The Agriculture Club in Sunitha's school wishes to set up a vegetable garden. What suggestions can you give for a better yield?



Extended activities

1. Germinate seeds of five different vegetables and provide favourable conditions to all. Find out whether the duration of germination is the same for all the five.
2. The drumstick plant can be cultivated by planting stem cuttings and by seed germination. Observe your surroundings and find out similar plants that can form seedlings by different methods.
3. Collect seeds that disperse through different modes and prepare an album by classifying them.
4. Prepare a journal of traditional knowledge and proverbs related to agriculture.



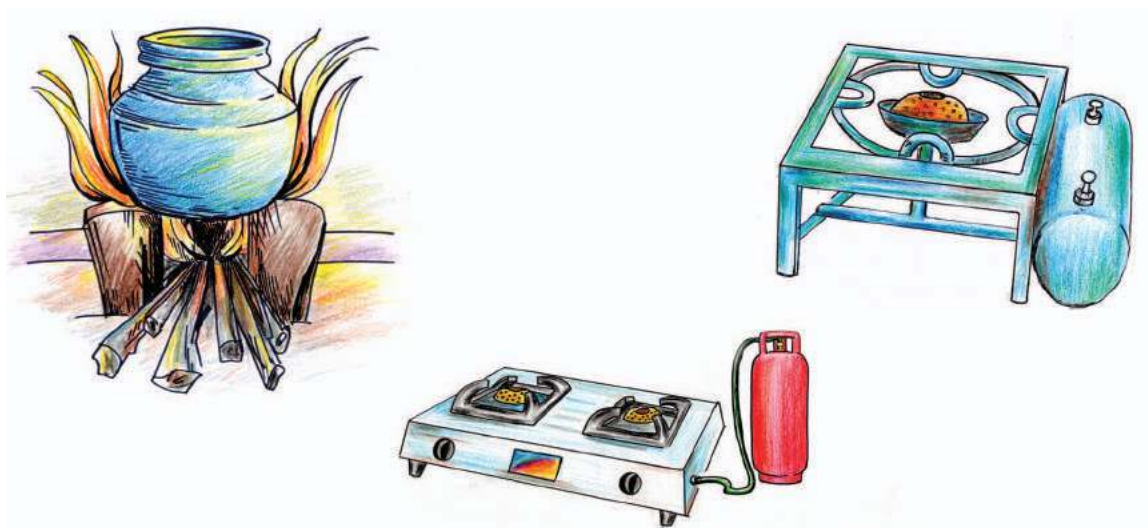

-
-
-

How is heat produced in a firewood stove? What are the substances burnt to produce heat in a kerosene stove and a gas stove?

Fuels

Fuels are substances which liberate heat on burning. Substances such as firewood and kerosene, used for cooking, as well as those like petrol and diesel, used for running automobiles, are fuels. Firewood and coal are solid fuels. The components separated from petroleum such as diesel, petrol and kerosene are liquid fuels. LPG, CNG and hydrogen are gaseous fuels.

Are fuels used only for cooking?

Look at the pictures



You know that the energy required for running vehicles is obtained from the fuels used in them. You also know the fuels used in motor cars and buses. The fuel used in aeroplanes is known as aviation fuel. Fuels produce energy by burning. Hence all fuels are sources of energy.



Food

Where do you get the energy for running from? We do a lot of activities everyday. Energy is required for doing these activities. This energy is obtained from food. Thus the food we eat is a source of energy.

When fuels burn

Do fuels burn on their own? Look at the picture.

The firewood stove has ember but it is not burning. What trick does your mother use to burn the firewood?

Let us do an experiment.

Place a lighted candle on the table top as shown in the picture. Cover the lighted candle with a glass tumbler.



What happens to the candle flame?

Why is the candle flame put out?

Record your findings in the science diary. Prepare a brief note on the experiment you have done. You would have understood that fuel alone is not sufficient for burning.



If there is no air...

Air is required for the burning of any substance. Fuels also require air for burning. It is the oxygen in the air that helps burning. Fuels liberate energy by reacting with oxygen in the air. In our body also, food reacts with oxygen to produce energy. Oxygen enters our body through breathing.

Now you can explain why your mother blows a pipe into the firewood stove to burn firewood. You can write down your explanation in the science diary.

By now, you would have understood that firewood burns well in a stove only with an adequate supply of air.



While using a firewood stove....

Do not pack the stove with excess firewood. Ensure adequate air supply. Firewood should be cut into small pieces before being placed in the stove. Firewood should be utilised completely. Clean the stove everyday. Clean the chimney once a month.



What other peculiarities should a good stove have?

The picture shows a woman cooking food.

What are the difficulties she experiences?

What changes should be made to make a firewood stove better?

Discuss and write down in the science diary.

A good stove

- A good stove produces maximum heat from the fuel used.
- Air passage should be smooth.
- The heat produced should reach the vessel fully. This helps to make cooking easier and to save fuel.
- There should be provision for smoke to escape.

Write down in your science diary what should be done to make the firewood stove in your school a more efficient one.

Vehicles Multiplying



Look at the picture. How much fuel do these vehicles consume daily!
What are the instances in which large amount of fuel is used?
What will be the consequences in future, of the excessive use of fuels?
Are all the sources of energy we use inexhaustible?



Petroleum refinery

(It is here that petrol, diesel etc. are separated from petroleum)



Solar Panel



Windmill

Observe the pictures.

What are the energy sources made use of in the devices indicated in the pictures?

Which among these are exhaustible and which are not?

Conventional energy sources

Petroleum is formed from decayed living organisms buried deep under the earth for millions of years due to some natural phenomena. Coal is formed from plant remains. These are called fossil fuels. Such fuels cannot be replenished once they get exhausted. They are called conventional fuels. In future, conventional fuels will get exhausted if not judiciously used. Petroleum is mainly used to produce petrol, diesel, kerosene, tar and LPG. In addition, it is used in the manufacture of many products like pesticides, plastics and medicines.

Non conventional energy sources

However much they are used, solar energy, wind and sea waves are energy sources which are inexhaustible. These are called non conventional energy sources.

Write down in the science diary all that you have understood about different sources of energy.

Take note of the newspaper reports



- What are the possibilities of energy sources mentioned in the newspaper reports?
- Make a list of devices working on solar energy. Do you have any of them at home?
- What are the advantages of making maximum use of non-conventional sources of energy for our needs?



Solar panels at a Space Station

Write down in your science diary.

Solar Energy



Calculator



Solar Street Lamp



Solar Heater



Solar Cooker

Look at the pictures. Do all these devices work using the energy from sunlight? Solar cell is a device which converts solar energy into electrical energy. Solar panels contain rows of solar cells. These are rectangular panels made of silicon.

The advantages of energy are that it is inexhaustible and that it does not cause pollution. Lamps, cookers, water heaters and calculators working with solar energy are widely used nowadays.

Wind Energy

Wind mills produce energy from wind.



Wind farm

The blades of the mill rotate by the power of wind. This rotation leads to the working of the generator. Thus electricity is produced. Visit a windmill farm during your next study tour.

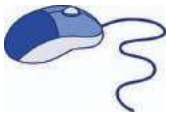

See the video '*Kaattil Ninnu Vyduthi*' (Edubuntu-School resource)

Towards the future, with care

Firewood is a conventional source of energy. But coke and gases produced when it burns, cause atmospheric pollution. Moreover, excessive use of firewood leads to deforestation. The consumption of fuels is also increasing day by day. Only through strict control of the consumption of fuels like coal and petroleum and maximum utilisation of non conventional energy sources, can the energy crisis be overcome in future.

Wastage of Fuels

There are various instances in daily life of fuels being wasted.

Do you store for further use the remains of charcoal and firewood in the stove after cooking?

Should we use private vehicles rather than public transport for travel?

Don't you see the widespread use of luxury vehicles despite the fact that many of them have poor fuel efficiency? What will be your attitude in such situations?

Do the following activity with the help of elders to understand how electrical energy is wasted in our homes.

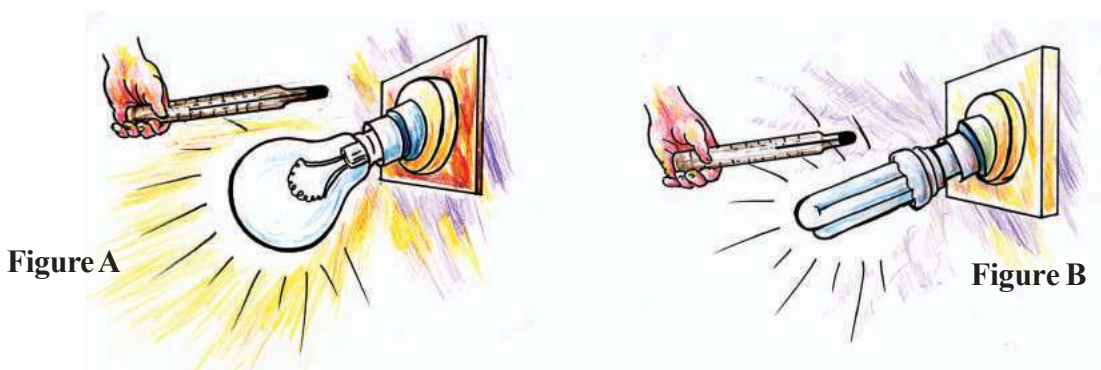

As shown in figure A, hold a thermometer near an illuminated filament bulb. Note down the thermometer reading.

After the thermometer attains room temperature, hold it near an illuminated fluorescent bulb as shown in Figure B. Note down the thermometer reading.

Which bulb releases more heat? The purpose of a bulb is to produce light. When the bulb gets heated up, it causes loss of energy.

Write the note of the experiment in your science diary.

The filament bulb requires more electricity to work. But a CFL (Compact Fluorescent Lamp) giving the same amount of light requires less electricity. Hence CFL is better to save energy. LED lamps capable of saving greater amount of energy are now available in the market.

What steps can be taken to save energy at home?

Examine the pictures



Fuel efficient firewood stove



Biogas Plant

We conserve energy sources when we do not waste fuels.

Can't we do several things at home itself to conserve energy?

- What are the ways to control the consumption of electricity?
- What are the changes to be introduced in the devices and sources of energy for cooking?

Write down in your science diary your plans for energy conservation.

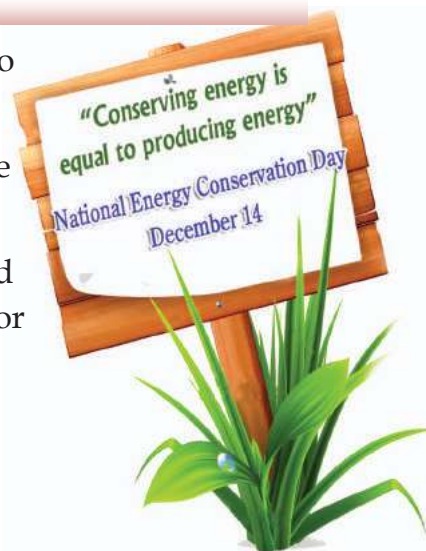

Conduct a seminar in the class on “How to prevent the excessive use of fuels.”

What are the details to be gathered for presenting in the seminar?

- Fuels used at home
- What are the purposes for which fuels are used?
- What should be done to increase fuel efficiency and to ensure energy conservation?
- Fuels used in vehicles.
- How can the fuel consumption in vehicles be reduced?
- What are the other areas in which energy sources are utilised?
- What are the ways to utilise non conventional energy sources?
- How can the idea ‘Saving energy is equal to producing energy’ be propagated?

Based on the information collected, prepare a seminar report. Introduce the ideas in the science club meeting.



Significant learning outcomes

The learner can

- tabulate different kinds of fuels and their uses.
- classify fuels into solid, liquid and gaseous fuels with examples.
- suggest and implement different ways of increasing fuel efficiency and conservation of fuels.
- classify energy sources into conventional sources and non-conventional sources and explain them.
- identify and explain the need to conserve conventional energy sources.
- take up and organize activities of energy conservation.



Let us assess

1. Why is it said that the sun is the source of all forms of energy?
2. An incubator is used for the artificial hatching of eggs. Which type of bulb is suitable for this?
3. Examine the instances given below and find out those which help in the conservation of fuels. Give reason and explain.
 - i. Babu uses a cycle to go to the shop though he owns a motor cycle.
 - ii. Rahim uses a motor car only when he travels with his family but uses bus for travel at other times.
 - iii. At Sathi's home, her parents and other members of the family use the electric iron at different times.
 - iv. As Raju keeps all the windows open during the day, he gets enough light and breeze. He doesn't have to use a lamp or fan.
 - v. Aswathy operates the television set using the remote controller only and never switches off the power.



Extended activities

1. December 14 is observed as National Energy Conservation Day. Prepare a notice to create an awareness of energy conservation activities.
2. Fuel Survey: Find out through a survey of ten houses near your place the amount and cost of fuel used per month for cooking and various other purposes, including the use of vehicles.

