

Higher Secondary Course

PHILOSOPHY - Part I
Logic and Reasoning

Class - XI



Government of Kerala
Department of Education

State Council of Educational Research and Training
(SCERT), KERALA
2016

The National Anthem

Jana-gana-mana adhinayaka, jaya he
Bharatha-bhagya-vidhata.
Punjab-Sindh-Gujarat-Maratha
Dravida-Utkala-Banga
Vindhya-Himachala-Yamuna-Ganga
Uchchala-Jaladhi-taranga
Tava subha name jage,
Tava subha asisa mage,
Gahe tava jaya gatha.
Jana-gana-mangala-dayaka jaya he
Bharatha-bhagya-vidhata.
Jaya he, jaya he, jaya he,
Jaya jaya jaya, jaya he!

PLEDGE

India is my country. All Indians are my brothers and sisters.
I love my country, and I am proud of its rich and varied heritage. I shall always strive to be worthy of it.
I shall give my parents, teachers and all elders respect, and treat everyone with courtesy.
To my country and my people, I pledge my devotion. In their well-being and prosperity alone lies my happiness.

Prepared by :

State Council of Educational Research and Training (SCERT)

Poojappura, Thiruvananthapuram - 695012, Kerala.

Website : www.scertkerala.gov.in e-mail : scertkerala@gmail.com

Phone : 0471 - 2341883, Fax : 0471 - 2341869

Typesetting and Layout : SCERT

© Department of Education, Government of Kerala

To be printed in quality paper - 80gsm map litho (snow-white)

Dear learners,

The State Council of Educational Research and Training (SCERT) is extremely happy to bring out the textbook for Philosophy for the first year higher secondary learners.

This textbook focuses mainly on logic, which provides the axiomatic framework for determining truth/falsity in all realms of human knowledge. It helps us to comprehend the structure of human thought in its dynamic contexts of analysis and argumentation. Though originally a contribution of philosophers; logical concern is recognised today as the inevitable component of all intellectual enterprises that invite keen analysis of the verbal expression of judgements, hypothesis and theories.

We hope that you will receive this textbook with great enthusiasm for learning the subject in its true spirit. The activities, case studies and anecdotes given in the textbook help you to practise logic for everyday life.

The SCERT is grateful to the team of practising teachers and subject experts who joined us in preparing the textbook. We welcome all creative and constructive suggestions and feedback about this book which would be useful for improving the quality of the content and design of this textbook.

Dr P. A. Fathima
Director
SCERT, Kerala

Textbook Development Team

Antony Das.M

HSST, Govt. HSS for Girls,
Kayamkulam, Alappuzha

Dr. Chandini

HSST, GHSS, Azhikkode, Kannur

Sri.Joy A

HSST, St. Joseph's HSS,
Thiruvananthapuram.

Kunhabdulla.M.K

HSST, MIM HSS, Perode,
Nadapuram, Kozhikkode

Pramod.P.A

HSST, GVHSS, Parayancheri,
Kozhikkode

Rajesh.K.K

HSST, KKM Govt. HSS, Orkkatteri,
Vatakara, Kozhikkode

Rakhi.P

HSST, NSS HSS, Kunnamthanam,
Pathanamthitta

Ranjith Babu.E.R

HSST, GHSS, Pannur, Kozhikkode

Shini.M

HSST, GHSS, Kadancheri,
Malappuram

Vrinda.M.S

HSST, GHSS, Chengamanad,
Ernakulam

Experts

Dr. M. Ramakrishnan,

Associate Professor (Retd.), Govt. Brennen College, Thalassery.

Dr. G. Padmakumar,

Associate Professor (Retd), Govt. College for Women, Thiruvananthapuram.

Dr. S.A. Shajahan,

Associate Professor, University College, Thiruvananthapuram.

Dr. R. Lakshmi,

Asst. Professor, Govt. College for Women, Thiruvananthapuram.

Dr. Radharani.P,

Asst. Professor, University College, Thiruvananthapuram.

Artist

Sri. C. Rajendran, A.V. Govt. BHS, Thazhava, Karunagappally.

Academic Co-ordinator

Dr. Jayalekshmi.S

Research Officer, SCERT

CONTENTS

1.	INTRODUCING LOGIC	7
2.	PROPOSITION	28
3.	INFERENCE	55
4.	SYLLOGISM	75
5.	OBSERVATION AND EXPERIMENT	101
6.	SCIENTIFIC METHOD	121
7.	CAUSALITY	140
8.	HYPOTHESIS	159
9.	SYMBOLIC LOGIC	173
10.	THE LOGIC OF RESEARCH	196
	BIBLIOGRAPHY	214
195		

**Certain icons are used in this
textbook for convenience**



Let us do



Let us check



Let us know

1

INTRODUCING LOGIC

KEY CONCEPTS

- Philosophy: Meaning and Definition
- Branches of Philosophy
- Logic: Meaning and Definition
- Laws of Thought
- Logic and Other Sciences
- Logic and Psychology
- Logic and Ethics
- Utility of Logic.

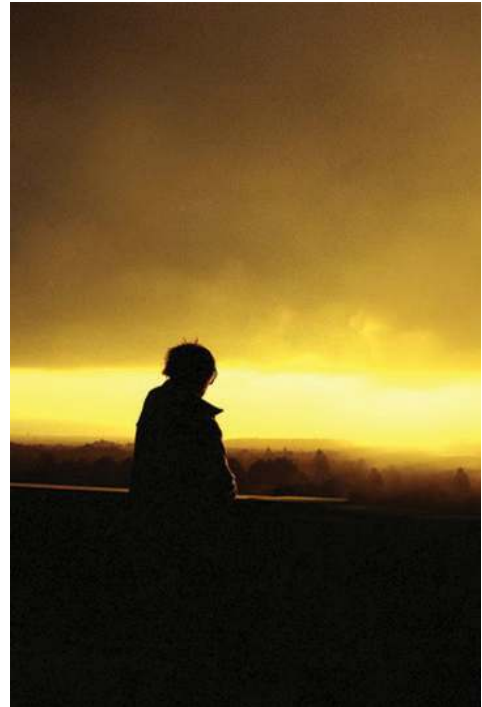

This chapter introduces philosophy and its functions in our life. We learn different definitions of philosophy and its branches. Logic is one of the branches of philosophy. There is also a comparative study of logic with other sciences. This is only a very brief introduction to philosophy and logic.

Philosophy: Meaning and Definition

Let us look at the write-ups about Socrates and Dr. S. Radhakrishnan. They are prepared by two higher secondary students for their school magazine.



Socrates was a famous Greek thinker. He was born in 470 BC. We know about him from the writings of his students. His **method** was his great contribution. He searched for solutions to problems in life. For that, he asked simple questions. He often found answers from the problems itself. This method is known as **Socratic or dialectic method**. His way of solving problems attracted people. But the rulers disliked him. He was accused of corrupting the youth. Finally, he was killed by giving poison.

Dr. S. Radhakrishnan was the second President of India. He was born on **September 5, 1888**. He came from Tirutani in Tamilnadu. He was a famous thinker as well as a great teacher. His birthday is celebrated as Teachers' Day. '**The Ethics of Vedanta and its Material Presupposition**' was his first book. His other major books are 'Indian Philosophy' and 'The Principles of Upanishad'.



Activity 1

Prepare a Profile of any one of the above personalities.

Include the following information.

Name of the personality

Period of life :

Country :

Important Works :

Main Thoughts :

A quote :

..... :

What is the speciality of this profile?

Who is a philosopher?

What is philosophy?

These are interesting questions. But they are not ordinary questions. Philosophy is the study of ultimate reality. It also deals with the fundamental principles of existence. These principles try to unify and go beyond religions, faith and scientific knowledge. Philosophy differs from special sciences because it attempts to give a picture of human thought as a whole.

There are situations in our life that make us think philosophically. But we are not always aware of it. Most of us take this world for granted. But some are very thoughtful and reflective. They have questions like what the world itself is, how it came to be, what it is made of and what for. When their questions become serious and follow a systematic inquiry, they are philosophers. Plato said that philosophy begins in wonder. He understood it to be the perception of ideas. Socrates defined philosopher as a seeker after wisdom. Philosophical thinking is different from ordinary thinking. Philosophy opens up new areas of study and new methods of enquiry.

Philosophy is related to everyday life. It is an attitude towards life. Philosophy helps one to lead a happy life. For this one needs a right attitude and high motivation.

The wisest of Greeks



The Oracle of Delphi said that Socrates was the wisest of Greeks. But Socrates replied, "I know only one thing; and that is that I know nothing".

How to become wise?



Friend: "Nasrudin, how does one become wise?"

Nasrudin: "Listen attentively to wise people when they speak. And when someone is listening to you, listen attentively to what you are saying!"

"Philosophy is that which grasps its own era in thought."



*Georg Wilhelm
Friedrich Hegel
(1770 -1831)*

Logic and Reasoning

Openness, courage and caring are some aspects of the right attitude to lead a happy and fruitful life. These will promote a rational dialogue by exchanging, amending and evaluating our ideas. Hence, philosophy is a way of life, recognising others and the world as a whole.

Philosophy can be defined as the rational systematic and critical inquiry into the basic principles of any dimension of reality or the reality as a whole.

Look at the tree diagram and find out the relation between philosophy and other sciences.

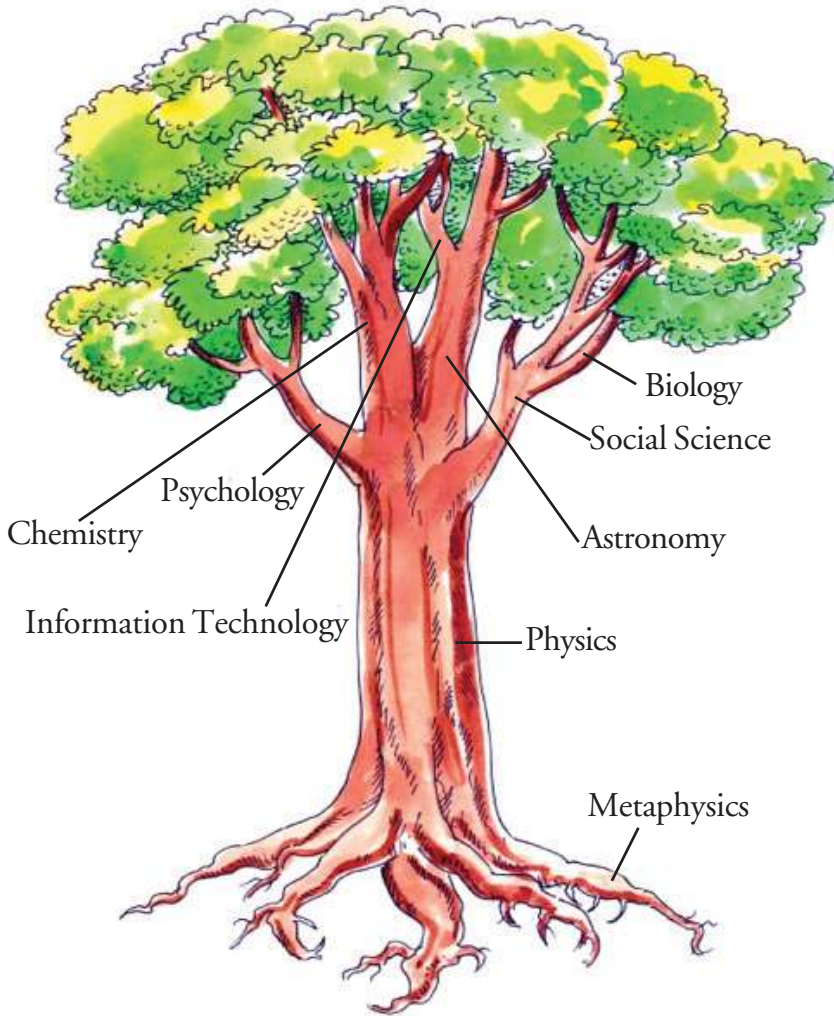

"All Philosophy is like a tree, of which Metaphysics is the root, Physics the trunk, and all the other sciences the branches that grow out of this trunk..." *Rene Descartes*

The term philosophy is derived from two Greek words '*philo*' and '*sophia*'. The word '*philo*' means 'love' and '*sophia*' means 'wisdom'. Thus philosophy is 'love of wisdom'. The word philosophy was first coined by the Greek philosopher Pythagoras. But the word 'Philosopher' was first introduced by Plato to distinguish his style from that of Sophists.

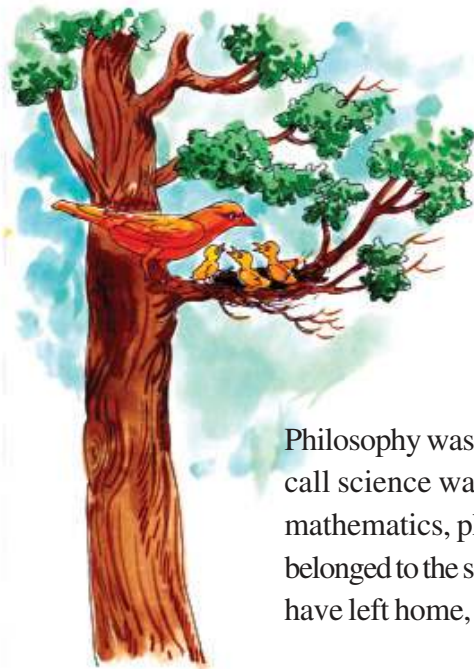

"Philosophers have interpreted the world, but the question is how to change it."



Karl Heinrich Marx
(1818-1883)-

"Philosophy is not a theory but an activity."



Ludwig Josef Johann Wittgenstein
(1889 -1951)

Philosophy was the first science until 1840. What we now call science was natural philosophy. In the beginning, mathematics, physics, logic, metaphysics, ethics etc. all belonged to the same family. Although many of her children have left home, some seem to be permanent residents.

Let us check



Don't you have your own definition of philosophy when you say "this is not my philosophy" or "this is not his philosophy?"

Write down your definition of Philosophy.

.....
.....

Branches of Philosophy

Let us see some of the issues faced by all of us.

“Things come and go, then what are eternal things?”

“If there are such eternal things, how can we know them?”

“If this life is so precious, but uncertain, how can we live it?”

These three questions give rise to the ‘three big problems’ in philosophy, the problem of knowledge, the problem of value and the problem of reality. These three represent the three areas in philosophy.

They are:

- A. *Metaphysics*
- B. *Epistemology*
- C. *Axiology*



Activity 2

Are you concerned about those that are not physical?

Is there anything outside the physical world?

List out those non-physical things you know.

-
-
-

A. Metaphysics

The word “metaphysics” is derived from the Greek words *metá* (beyond, upon or after) and *physiká* (physics). Metaphysics can be defined as 'a science beyond physics.' It is concerned with the nature of ultimate reality. It deals with different questions. e.g. “*What does truly exist? what is ultimately real? how reality is ordered and organised?*” So metaphysics is the study of the most general features of reality, like existence, time, the relationship between mind and body, objects and their properties, whole and part, events, processes, and causation. Traditional branches of metaphysics include ontology and cosmology. Ontology is the study of *Being* where as Cosmology is the study of *World*.

B. Epistemology



Activity 3

How do you acquire knowledge?

- Eyes bring us images, colours, shapes etc.
-
-
-
- Mind

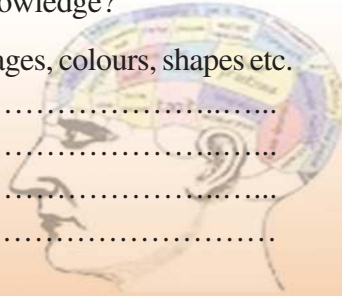

The word ‘epistemology’ means ‘science of knowledge’. It is derived from two Greek words ‘*epistem*’ meaning knowledge and ‘*logos*’ means science. The basic question asked in epistemology is “How do we know”? It studies about the sources and limits of knowledge and related concepts. It looks into the types of possible knowledge and the degree to which knowledge is certain. It also deals with the exact relation between the knower and the object known. Logic is part of epistemology. It provides the tools for distinguishing between truth and falsity of knowledge. Logic is the study of correct reasoning.

C. Axiology

Write a short story in a few words based on the picture.

Write about the picture in a single sentence.



Logic and Reasoning

The two images show the value of 'a good action' and 'a beautiful thing' respectively. Axiology is the science of values. It deals with questions like *what is goodness?*, *what is right?* and *what is beauty?* The science that deals with the value of goodness is Ethics and that of beauty is Aesthetics. Ethics investigates the concepts of 'right' and 'good' in individual and social conduct. Aesthetics studies the concepts of 'beauty' and 'harmony' in nature and and arts.

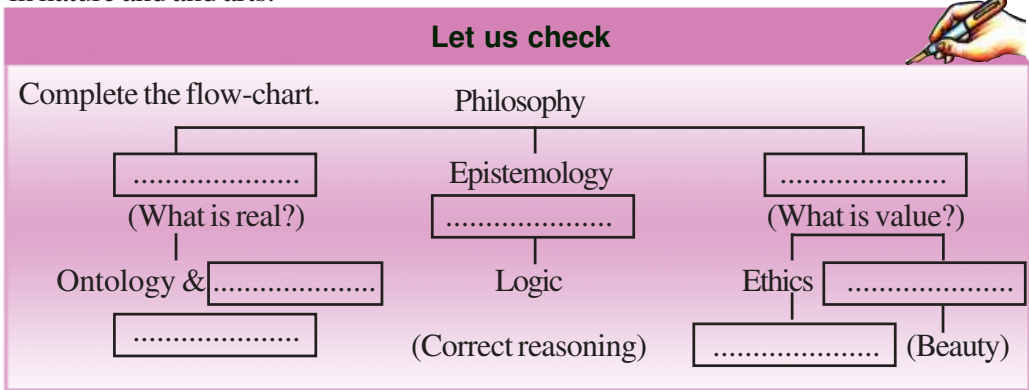

Logic: Meaning and Definition

Logic is the foundation of all philosophical thinking. Therefore the study of Logic is fundamental to philosophy.

Let us solve the following.



Activity 4

- If *Book* is to *Watch*, *Watch* is to *Bag*, *Bag* is to *Dictionary* and *Dictionary* is to *Window* then what will you use to carry your books?
(Dictionary, Book, Bag, Watch, None of these.)
- PSRQ: CFED :: MPON:.....
(HKJI, HJKI, HIKJ, JHIK)
- Stephen was looking at a photo. Someone asked him, “whose picture are you looking at?” He replied, “I don’t have any brothers or sisters. But this man’s father is my father’s son.”
Whose picture was Stephen looking at?

What faculty of your mind have you used to find out the solutions to the above problems? ‘Reasoning’ must be your response! Logic deals with this faculty of human beings. The word logic is derived from the Greek word ‘Logos’ which means ‘word, speech, reason or thought.’

THE DEVELOPMENT OF LOGIC



Logic was developed independently and brought to some degree of perfection in China (5th to 3rd century BC) and India (from the 5th century BC through the 17th century AD). Logic as it is known in the West comes from Greece. Aristotle worked out the first system of the logic in the 4th century BC. The logic of propositions comes from the work of Aristotle's pupil Theophrastus, the 4th century Megarian school of logicians and the school of the Stoics. After the decline of Greek culture, logic re-emerged first among Arab scholars in the 10th century. The works of St. Anselm of Canterbury and Peter Abelard showed medieval interest in logic. Its high point was the 14th century. The Scholastics developed logic during this period, especially the analysis of propositions, well beyond what was known to the ancients. Rhetoric and natural science overshadowed logic during the Renaissance. Modern logic began to develop through the work of the philosopher and mathematician G.W. Leibniz. He attempted to create a universal calculus of reason. Great progress was made in the 19th century in the development of symbolic logic. It combined logic and mathematics in formal analysis.

Modern formal logic is the study of inference and propositional forms. Its simplest and most basic branch is propositional calculus. In this logic, propositions or sentences are treated as simple and unanalysable. Attention is focused on how they are related to other propositions by propositional connectives (such as "if... then," "and," "or," "it is not the case that," etc.) and formed into arguments. It is possible to study abstract characteristics of formal logic. It is done with the help of symbols and set of transformation rules.

According to Creighton 'logic is a science that deals with the operations of the mind in its search for truth'.

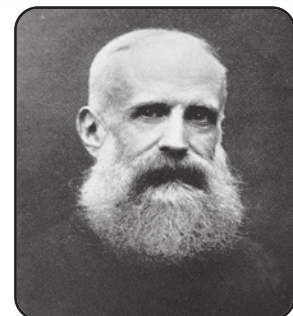

James Edwin Creighton
(1861 - 1924)

Logic and Reasoning

Let us analyse the three constituents of logic from the above definition.

- I. Logic is a science.
- II. Logic deals with the operations of the human mind.
- III. The aim of logic is the search for truth.

I. Logic is a Science

You have studied many sciences. They have certain common features.

Try to list them.

-
-
-

Science has a definite structure, aim and method. It is a systematic and exact body of knowledge about a particular part of the universe. Science should have the following three characteristics.

- ❖ It should deal with a part of the universe.
- ❖ It should be a systematic and organised body of knowledge.
- ❖ It should give us certain and correct knowledge.

Logic is a science because it has all these characteristics. There are two kinds of science. They are normative science and positive science. Positive science deals with things as they appear in nature. It is also known as natural science or descriptive science. e.g. physics, chemistry, biology, economics, psychology, sociology etc.

a. Logic is a normative Science

Normative science deals with things as they 'should be' or 'ought to be'. It sets up a 'norm' or 'standard' or 'ideal' to evaluate their subject matter. It is also known as regulative or evaluative science.

'Logic is the art of reasoning'

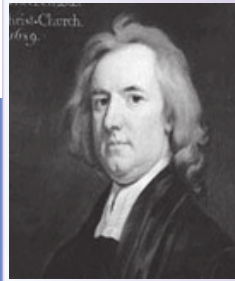

Henry Aldrich
(1647 - 1710)

'Logic is an art and science of reasoning'



Richard Whately
(1787-1863)

Logic sets up 'truth' as its ideal. It teaches us how our thoughts ought to be to reach the truth. Thus logic is a normative science. The other normative sciences are Ethics and Aesthetics.

b. Logic is a formal science

Is there any object without form or shape? Think and share.

All objects in nature are made up of matter. They have a certain shape or form of that matter. In the same way our thought also has certain form and matter. By form we mean the way in which our mind thinks about something. Form is pattern, shape, design or structure. By matter we mean the things about which our mind thinks. Matter is the content of our thought. Logic is mainly concerned with the ways of thinking or forms of thought. Hence, logic is called a formal science.

II. Logic Deals with the Operations of Mind



Activity 5

What are the things that our mind do for us?

List them.

-
-
-

All our mental activities can be classified into three categories. They are *thinking*, *feeling* and *willing*. Logic is concerned only with the thinking part of the mind.

The categories of thinking consist of three operations. They are:

- a. Conception
- b. Judgment
- c. Reasoning.

Logic and Reasoning

a. **Conception**

Amal is looking at a camel.



He is forming an idea/image of the camel in his mind.

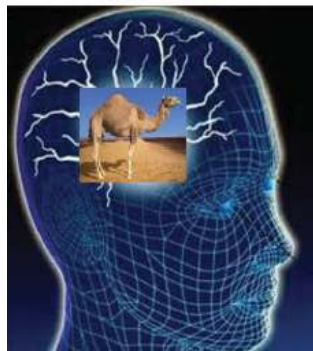

The mental image formed in the mind is conception. When we express an idea in language it is known as a **term**. Here the word 'camel' becomes a term.

b. **Judgment**

Amal and his friend Rahul look at the following picture.

Amal: Can you identify this animal.

Rahul: Of course. Its an **anteater**.

Amal: Is anteater a mammal or an oviparous?

Rahul: *Anteater is a mammal. It is not an oviparous.*



Rahul’s last exchange in the conversation is an act of judgment.

Making Judgment is another operation of mind. It should have at least two ideas. One idea is either affirmed or denied of another. When a judgment is expressed in words it is known as proposition. Example ‘Anteater is a mammal.’

c. Reasoning

Let us solve this problem.



Activity 7

Seena is taller than Baby but shorter than Jeenu. Sona is taller than Baby but shorter than Seena.

Who is the tallest among them?

.....

(Jeenu, Seena, Baby, Sona)

How did you reach this conclusion?

From the known facts you derived a conclusion. This is reasoning. **Reasoning the mental process of passing from one or more known judgments to a new judgment.** When reasoning is expressed in words it is called an **argument**.

Let us check



a. Make propositions and arguments out of the given terms.

- Rafflesia
- Mangalyan

b. Complete the flow chart.

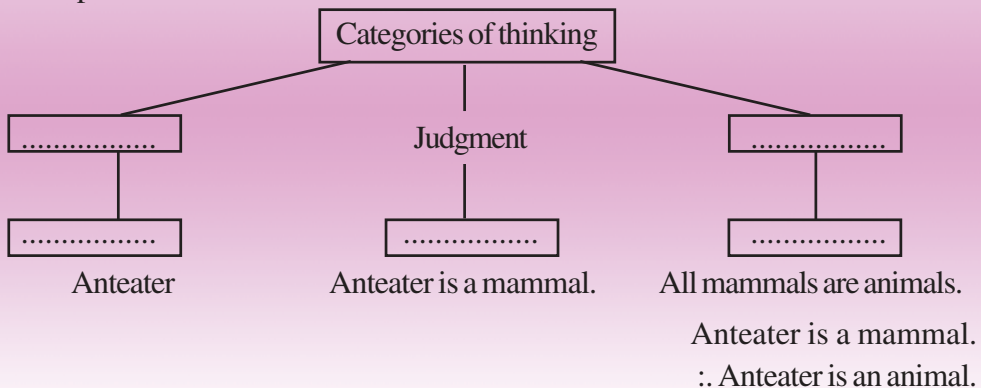

III. The Aim of Logic is Search for Truth

Look at the pictures.



Which is real and which is imaginary.

-
-

Truth is either material or formal or both. Material truth is confirmed by the consistency between the statements and facts, which exist in the real world. So material truth can be recognised by sense perception.

Formal truth is concerned with the fact as it is stated i.e. in the form of a judgement. Looking at the pictures above we can make judgement/statement about them, e.g. 'the winged horse is flying' [A] and 'the waterfall is beautiful [B].' Now you can find out which of these statements is materially true, formally true and both formally and materially true.

Tick the appropriate column		
Truth	A	B
Materially true		
Formally true		
Both formally and materially true.		

That part of logic which deals with formal truth is called **deduction**. The part of logic which deals with material truth is called **induction**.

Let us check



Write a few examples for formal truth and material truth.

.....

The Laws of Thought

The aim of logic is search for truth. Truth is possible only through correct thinking. Correct thinking is based on certain principles. According to Aristotle, these principles are the fundamental Laws of Thought.

- 1) The Law of Identity
- 2) The Law of Contradiction
- 3) The Law of Excluded Middle.

Besides these three laws, Leibnitz had put forward a fourth law known as ‘the Law of Sufficient Reason’.

1) The Law of Identity

According to this law ‘if anything is A it is A or if any proposition is true it is true’. Everything is identical. Each object should be taken as it is. In short “that everything is the same with itself and different from another”. e.g. A kilogram is a kilogram and a pound is a pound.

2) The Law of Contradiction

This law expresses A cannot be B and not B at the same time. In other words a thing cannot both exist and non-exist at the same time. Nothing can have contradictory qualities in the same space and time. e.g. If you say that Ram is in the house, it cannot be said that he is not out of the house. One cannot assert that Ram is at the same time in the house and out of it. Hamilton has



The Law of Identity can be expressed as follows:-

1. What is, is:- It has been pointed out by the *Bhagavat Gita*, that whatever exists cannot be non-existent and whatever is non-existent cannot exist. In other words, what is, is, and what is not, is not.
2. Each object is equal to itself:- Everything is identical. Each object should be taken as it is.
3. A thing is what it is:- The nature of a thing has some fundamental elements which show its basic properties and function. For example, a man is a man, but not angel or something else.
4. Truth is coherent:- Every principle must be explained in consistency with its basic fact since truth lies in coherence. While examining a philosophical thought it should not be compared with other philosophical thinking. The two are different. In order to examine the truth of a principle we should enquire about its self-consistency. The logical implication of its basic facts should be the same from the beginning to the end. Otherwise it is far from being consistent.

Logic and Reasoning

called the law of contradiction as the law of non-contradiction. According to him correct thinking is non-contradicted. E.g. A thing cannot be white and non-white at the same time.

3) The Law of Excluded Middle

According to this law everything must be either True or False, i.e. A or not A. For example. A piece of toffee can either be sweet or not sweet. According to Jeevons, “the very name of the law expresses the fact that there is no third or middle ground; the answer must be YES or NO.” The given person is either Socrates or not Socrates.

4) The Law of Sufficient Reason

Everything must have a sufficient reason '*why it is so and not otherwise.*' Leibnitz says that there must always be some sufficient reason why a thing is what it is. This Law is also known as Law of causation.

Logic and other Sciences

We have seen that logic is a science. Let us discuss how logic is related to other normative and positive sciences.

Logic and Psychology

Logic and psychology are sciences dealing with mental functions or consciousness. They study about what goes on in mind. Logic is a normative science. Psychology is a positive science. The word psychology comes from two Greek words '*psycho*' and '*logos*'. The '*psycho*' means mind and '*logos*' means science. Thus psychology means science of mind. Psychology deals with the thought processes 'as it is' without any reference to ideals or the attainment. It deals with the actual structure of mental process. It is the science of behavior in general. This includes thinking, feeling and willing. It describes pleasure and pain, acts of will and association of ideas.

Let us check



Complete the following chart.

Logic	Psychology
• Normative Science	•
•	•
•	•
•	•

Logic and Ethics

Logic and ethics are normative sciences. Both these sciences deal with human mind and its various operations. Logic deals with norms of correct reasoning. But ethics focuses on norms of right conduct. The word ethics is derived from the Greek word 'ethos' which means custom or character. It is also known as moral philosophy. Human conduct is judged to be right or wrong against the standard of goodness. Goodness is the concern of ethics. Ethics is the science of the ideal in conduct, as logic is the science of the ideal in thinking. They agree in method but differ in scope.



Major areas of Ethics

- **Meta-ethics:** It is about the theoretical meaning and reference of moral propositions and how their truth values (if any) may be determined.
- **Normative ethics:** It is about the practical means of determining a moral course of action.
- **Applied ethics:** It is about how moral outcomes can be achieved in specific situations.
- **Descriptive ethics:** It is also known as comparative ethics. It is the study of people's beliefs about morality.

Let us check



Complete the lists with their respective features.

Logic

- Normative Science
-
-
-
-
-
-

Ethics

-
-
-
-
-
-
-

Utility of Logic

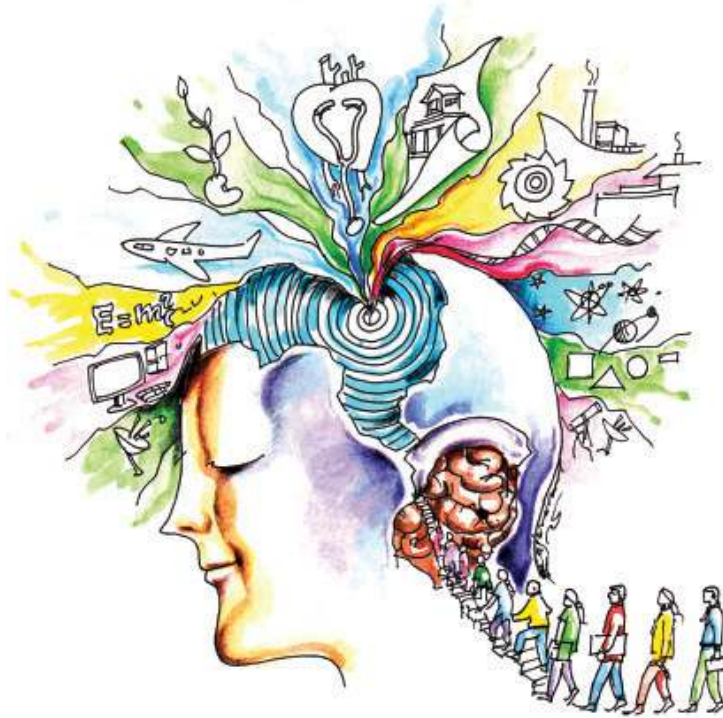

Is there any field that does not involve thinking?

Is every thinking correct?

Can't we identify the cause for errors in thinking?

Can we rectify those errors in thinking?

Do we have balanced mind?

How do we solve the problems in our daily life?

Application of logic involves solutions to all the above issues.

Logic is concerned with arguments, inference and reasoning. Such concerns are important to all of us in everyday life.

Let us discuss some of the applications of logic;

- Logic deals with the principles of valid reasoning. Truth can be obtained without errors. Logic teaches how to think clearly, systematically, consistently and precisely.
- Every discipline of science including mathematics uses logic for proving theorems.
- Information technology is another area where logic is used fruitfully.
- Logic corrects the confusion of ordinary language.
- Logic is applied in every professional field, like law, criminology, military intelligence, engineering, etc.
- Logic is a tool to manage day to day living. It is essential to solve life's riddles.
- Some theologians used logic to prove the existence of God.
- Logic is an excellent intellectual discipline or mental gymnastics.



Summary

Philosophy is the mother of all sciences. It is broadly classified into metaphysics, axiology and epistemology. Logic is a part of epistemology. It is a normative science of reasoning. It is related to other sciences like ethics and psychology. Logic is applied in every field of life.



I can

- identify the meaning and definition of philosophy.
- develop my own definition of philosophy.
- classify philosophy into metaphysics, epistemology and axiology.
- identify the meaning of logic.
- analyse the operations of thinking such as conception, judgment and reasoning.
- explain the fundamental laws of thought.
- differentiate between logic and other sciences.
- analyse the advantages of studying logical reasoning.



Let us assess

Exercise 1

- What should come next in the following letter series?
AABABCABCDABCDEABCDEF
a) B b) G c) D d) A
- 'Paragraph' is related to sentence. In the same way a sentence is related to
a) Paragraph b) Type c) Word d) Letter
- In a certain code language PULSE is written as DRKTO and NEW is written as VDM. How will PROBES be written in that code language?
a) RDANQO b) QSPCFT c) TFCPSQ d) OPNADR
- Prakash walked 30 meters towards west, took a left turn and walked 20 meters. He again took a left turn and walked 30 meters. He then took a right turn and stopped. Towards which direction was he facing when he stopped?
a) South b) North c) East d) West
- Find the next digit.
3, 7, 15, 31, _____
a) 65 b) 63 c) 59 d) 48
- LOGOS refers to LOGIC, ETHICS refers to _____.
- Tick the odd one out...
Anthropology, Physics, Astronomy, Aesthetics.
- Conception, judgment and _____ are the three operations of human mind.
- Identify the materially true object from the given things.
a) Sky lotus b) spider man c) golden mountain d) Taj Mahal.

10. Which of the following is the goal of logic?
- a) goodness b) beauty c) truth d) none of these

Exercise 2

- Write down the definition of logic given by Creighton. Analyse it.
- Construct a flow chart using the following hints.
Metaphysics – logic – philosophy – goodness – epistemology – what is reality?
– aesthetics – ontology – ethics – what is beauty? – axiology – what is truth? –
Study of beings.
- Logic and ethics are normative sciences. Identify the differences between them.
- Logic and Psychology are complementary to each other even though there are many differences between them. Specify the differences.
- In a group discussion Amal stated, “Logic is applied in all walks of life.”
Do you agree with this statement? Substantiate.
- Prepare a list of sciences and classify them in the following boxes.

Sciences		
Physical	Biological	Social

2

PROPOSITION**KEY CONCEPTS**

- Sentences in Language
- Logical Propositions and Grammatical sentences
- Kinds of Propositions
- Traditional Classification of Proposition
- Modern Classification of Proposition
- Distribution of Terms in Categorical Propositions
- Euler's Circles
- Reduction of Sentences to Logical form



This chapter analyses logical propositions and their differences with ordinary language sentences. The chapter aims at classifying propositions into traditional and modern. It analyses them using diagrams. It also changes reducing ordinary sentences into logical form.

Read the following statements.

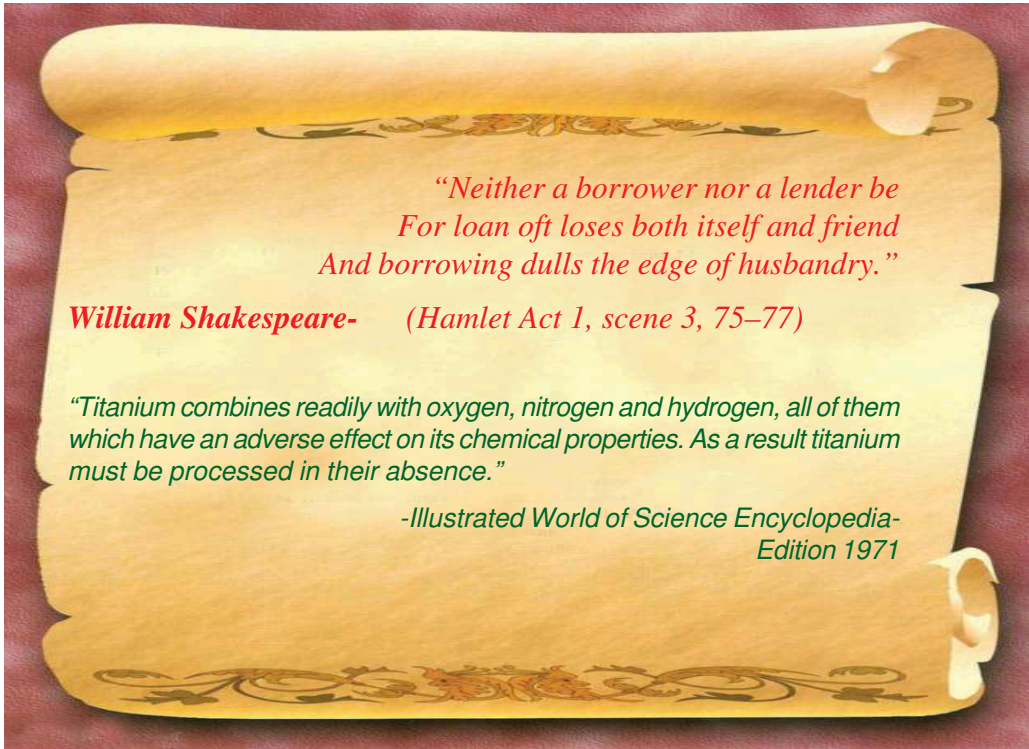

Shakespeare is trying to establish an opinion whereas the one from the 'Encyclopedia' is trying to establish a scientific fact. Mass media like newspapers, magazines, television, radio and all the social media on the Internet provide enough space for arguments. We argue to establish our convictions to be true and try to secure the approval of others.



Activity 1

- Think of a situation when you engaged in an argument with your friend, teacher or parent.
- Try to write any of the arguments in the form of a dialogue.

Logic and Reasoning

Read the following conversations between a father and his son and a doctor and his patient.

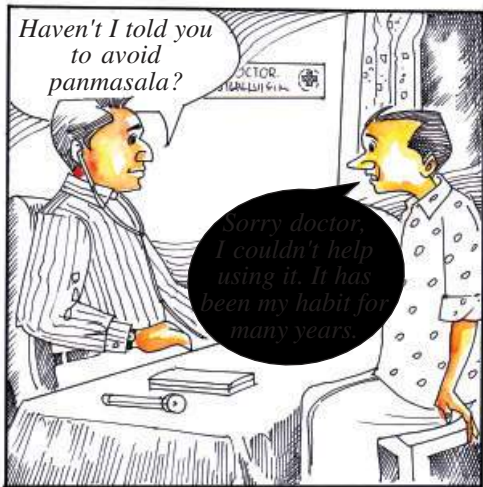

The above conversations express arguments which are there in every realm of our life.

However, how do we know our arguments are strong and valid?

It is in this context one recognises the aim of logic as to formulate proper methods and principles for evaluating arguments.

The study of logic gives us confidence when we argue with others to establish our reason to be true. An argument consists of a group of **statements** which support each other. A statement is a sentence that is either true or false – in other words, it is a **declarative sentence**. E.g. *'The earth revolves round the sun'*, *'Tablet computer is an electronic gadget'*. A statement or a declarative sentence in logic is called a **proposition**. The two hallmarks of a proposition are completeness of meaning and capacity to be either true or false. Proposition is the building block of logical reasoning.

Sentences in Language

A sentence is a group of words that gives a complete sense. It is the verbal expression of our thought. In other words, our thoughts are expressed through sentences in every language.

You may recall studying different types of sentences in your grammar class at school. Sentences that ask questions, e.g. *'Who is the present Prime Minister of India?'* are interrogative sentences. Sentences that express wonder, e.g. *'How cute!'* are exclamatory sentences. Sentences that express command or request, e.g. *'Remove the sandals from your feet, for this is a holy place.'* and *'Have mercy on me.'* are imperative sentences. The sentences that express a statement, such as *'The sun is a star'* are called declarative sentences. The scope of grammatical sentences is not restricted. Not only thoughts but also wishes, feelings etc. may be expressed in sentences.

Logical Propositions and Grammatical Sentences

We have already gone through various sentences in grammar. The logical proposition is rather different from grammatical sentences. Every sentence is not a proposition. Only those sentences which express what is either true or false are logical propositions. The sentences expressing questions, exclamations, commands or requests carry neither truth nor falsity. The interrogations like *"Am I the keeper of my brother?"*, the commands like *"Do your duty without caring for the reward"*, and the exclamation like *'Hurray!'* are not logical propositions. The question contains its own answer. It may in effect mean that *'I am not the keeper of my brother'* or *'I am the keeper'*. The command implies that duty is to be done without thinking of the reward. The exclamation refers to the fact that something good is achieved. So in such cases the proposition must be extracted and stated in logical form.

Let us check 

Try to complete the following table comparing the characteristics of Logical Propositions and Grammatical Sentences

Logical Propositions

- Every proposition is a sentence.
-
-
-

Grammatical Sentences

- Every sentence is not a proposition.
-
-

•\

Richard Whately refers to the proposition as '*an indicative sentence*', In other words it is a declarative sentence. In what is considered to be the Bible of logic, '*Prior Analytics*' Aristotle defines a proposition as '*a statement in which something is said regarding something else either affirmatively or negatively*'.



Richard Whately (1787-1863) was an English logician, economist, and theologian who also served the Church of Ireland as the Archbishop of Dublin 

The proposition '*Mahatma Gandhi is a human being*' declares affirmatively the human aspect of Mahatma Gandhi. The proposition '*No stars are planets*' denies the planetary feature of stars.

That about which something is declared, is the **subject** of the proposition; that which is declared of the subject is the **predicate** of the proposition. In the proposition '*All humans are mortal*' the subject is '*all human*' and the predicate is '*mortal*'. In the proposition '*Blood is thicker than water*' '*blood*' is the subject and '*thicker than water*' is the predicate.

**Activity 2**

Prepare a few propositions from the areas of Physics, Biology, Mathematics, Literature and Sports. Identify their subject and predicate.

Example.

- Some machines are robots.
Subject : machines
Predicate : robots

Traditional logicians followed Aristotle's analysis of propositions. Any statement to be a proposition must be in the proper logical form of '**S is P**' if affirmative and '**S is not P**' if negative. 'S' stands for the subject. 'P' stands for the predicate. Subject and predicate are linked with 'is' or 'are' in English. This connecting link between subject and predicate is called '*Copula*'. The function of copula is to express the unity of the terms in a proposition. Hence, *the structure of the logical proposition is subject and predicate connected by a copula*. Modern logicians, however, differ from Aristotle's analysis of proposition.



The reasons for modern logicians' disagreement with Aristotle's view of propositions

Traditional logicians supposed that every proposition was analyzable into subject and predicate. Therefore they must be expressed with the help of the verb forms of 'be'. According to them, a proposition such as 'Bagpipes make a horrid noise' should be restated as 'Bagpipes are things which make a horrid noise', for the logical form of subject-copula-predicate. But every proposition does not assert a predication, that is, attributes a characteristic to a subject. For example, '*Cats like fish*', '*Brutus killed Caesar*', '*John gave the man some money*' assert relations between subjects. They do not attribute a characteristic to the subject. We do not get rid of the relation by expressing the proposition '*Brutus killed Caesar*', in the verbal form '*Brutus is a killer of Caesar*'. Such a restatement is logically futile and it is practically absurd. The awkwardness of the sentences suggests their unsuitability to express what the proposition means. Propositions may have any number of constituents. These constituents may be combined in various ways. The traditional limitation to two constituents (Subject and Predicate) and to one mode of combination (predication) was an undue simplification.

Kinds of Propositions

As there is difference in the concept of the structure of proposition held by traditional and modern logicians, there is difference in the classification of propositions too. Hence we will study the two views of classification of proposition, i.e. traditional and modern.

Traditional Classification of Propositions

Propositions are generally classified as *categorical* and *conditional*. This is the traditional classification done by Aristotle.

A. Categorical Propositions

Read the following propositions.

- ❖ All cricketers are sportsmen.
- ❖ No novels are biographies.
- ❖ Some chemicals are medicines.
- ❖ Some papers are not A4.



Aristotle's theory of categorical proposition has been one of the core topics in logic for over 2000 years. It remains important even today because many of the statements we make in daily conversation are either Categorical propositions or can be readily transformed into them.

Traditional logicians called the above propositions “Categorical”. ***The categorical proposition asserts directly and without any condition. The predicate is either affirmed or denied unconditionally of the subject.*** In the proposition ‘All cricketers are sportsmen’ and ‘Some chemicals are medicines’ the predicates ‘sportsmen’ and ‘medicine’ are affirmed unconditionally of their subjects. In the proposition ‘No novels are biographies’ and ‘Some papers are not A4’ the predicates ‘biographies’ and ‘A4’ are denied **unconditionally of their subjects.**

Categorical propositions are classified on the basis of **quality** and **quantity**. Based on quality, the propositions are either Affirmative or Negative. ***An affirmative proposition is one in which an agreement is affirmed between the subject and the predicate.*** The proposition ‘All herbs are medicinal plants’, indicates such an agreement between the subject and the predicate. Therefore it is affirmative in quality.

A negative proposition indicates a lack of agreement between the subject and the predicate. The proposition ‘No ice creams are hot things’ shows a disagreement between the subject and the predicate. Therefore it is negative in quality.



Connotation and Denotation of Terms

Every term as subject and predicate has a double significance.

It refers (1) to an object or group of objects and (2) to a quality or a set of qualities. The objects to which the term is applied, form the denotation or the extension of the term. The attributes which it implies, form the connotation or intention of the term. A term then denotes objects and connotes qualities. Connotation is also known as its intention because it is what is intended by the term. Denotation is called extension because it refers to the various objects over which the predication of the term may extend. Thus in the proposition 'All lions are carnivorous', the term lion has extension or denotation in so far as it refers to the various individual lions or to the different varieties of lions like the African and the Asiatic, and it has intention or connotation in so far as it refers to the qualities or attributes of lions like being quadrupeds (four-legged), mammals, feline, etc. While denoting or naming an object, terms are employed in extension. When terms are used to define or describe things, they are employed in intention. Denotation and connotation are different aspects of the significance of terms. Every term must have both these aspects.

The quantity of a proposition is determined by the extension of subject. When the proposition refers to all of the individuals denoted by the subject, it is said to be **universal** in quantity. When, on the other hand, the proposition affirms that the predicate belongs only to a part of the subject, it is said to be **particular**. For example, '*All metals are elements*' is universal, because the assertion is made of the subject in its widest or fullest extent. '*Some metals are white*' is particular, because reference is made to only a part of the subject 'metal'.

According to quality and quantity logicians divide categorical propositions into four different types: Universal in quantity, affirmative in quality; Universal in quantity, negative in quality; Particular in quantity, affirmative in quality; Particular in quantity, negative in quality.

Logic and Reasoning

The categorical propositions are:

1. Universal affirmative
2. Universal negative
3. Particular affirmative
4. Particular negative.

The vowels A, E, I and O are traditionally used to refer to the four different types of propositions.

These symbols were traditionally based on the vowels in the Latin word '*affirmo*' for the affirmative propositions and the comparable vowels in the Latin word "*nego*".

Symbol	Name of proposition	Example	Logical Form
A	Universal affirmative	All chemicals are medicines.	All S is P
E	Universal negative	No chemicals are medicines.	No S is P
I	Particular affirmative	Some chemicals are medicines.	Some S is P
O	Particular negative	Some chemicals are not medicines.	Some S is not P

Let us check



From the given proposition create the other three categorical propositions.

A Proposition : All atoms are divisible.

E Proposition :

I Proposition :

O Proposition :



Boolean Analysis of Proposition

We can show the class distinction of categorical proposition by drawing two overlapping circles, labeling one circle 'S' for the subject term and the other 'P' for the predicate term.

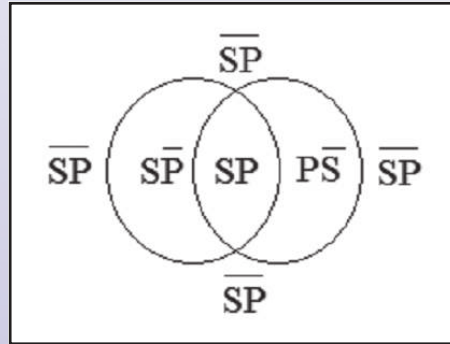

Fig. 1

The part of the circles overlapping can be denoted as the class of SP . To the left of the class of SP is the class of $\bar{S}\bar{P}$; to the right of the class of SP is $P\bar{S}$. The class outside all of the circle is the class of $\bar{S}\bar{P}$. A universal affirmative proposition states that the part of the circle designated S and not P ($S\bar{P}$) is null: it has no members. A universal negative proposition states that the part of the circle designated S is common to P (SP) is null. A particular affirmative proposition states that the part of the circle designated S that is common to P (SP) is not null: it has at least one member. A particular negative proposition states that the part of the circle designated S and not P ($S\bar{P}$) is not null: it has at least one member. To signify that a class is known to be empty, we shall use a shaded area, and to indicate that a class has a member, we shall insert a letter "x" in that place.

On the basis of Boolean analysis, the different types of categorical propositions are exemplified as shown in the fig. 2.

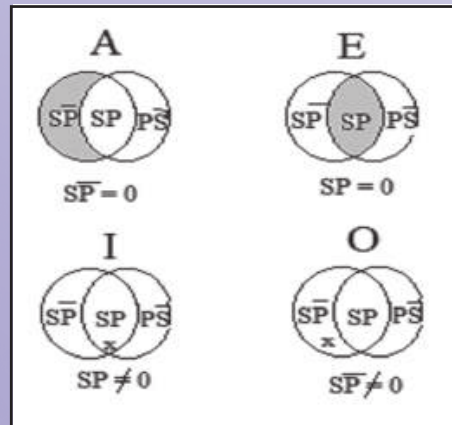

Fig. 2

B. Conditional Propositions

- If you destroy forests then you destroy our planet.
- A restaurant is either vegetarian or non-vegetarian.

These two propositions are called **conditional** by traditional logicians. The former is a **Hypothetical Proposition** and the latter a **Disjunctive Proposition**. Both of them state the facts with certain conditions or suppositions. It is just in contrary to categorical proposition which asserts the facts without any condition. **A conditional proposition is a complex proposition that affirms or denies something to something else conditionally.**

1. Hypothetical Proposition

The proposition ‘*If you destroy forests, then you destroy our planet*’ is a type of conditional proposition. There are two constituent parts in the same proposition. The condition or ‘if-clause’ is called the **antecedent**. The ‘then-clause’ is called the **consequent**.

2. Disjunctive Proposition

‘*A restaurant is either vegetarian or non-vegetarian*’ is a kind of conditional proposition. There are two constituent parts in this proposition, they are, ‘*A restaurant is vegetarian*’ and ‘*A restaurant is non-vegetarian*’. Such types of propositions are called Disjunctive proposition by traditional logicians. Disjunctive propositions are made up of “either ...or” or just placing the word “or” between the propositions. The constituent propositions are called **Disjuncts**.



“Hypothetical Proposition is one which connects a consequent with a condition which it does not, however imply to be necessarily fulfilled”.

-Joseph Diaz Gergonne (1771- 1859)

Let us check



Recall a few life situations when you were caught up with hypothetical propositions and disjunctive propositions. Identify their constituent parts.

- If you don't wear helmet, you will be fined.
Antecedent : Consequent :
- If then
- Antecedent : Consequent :
- Either or
- Disjunct 1 Disjunct 2

Modern Classification of Propositions

Modern logicians classify propositions into **simple** and **compound**. Let us analyse them in detail.

A. Simple Propositions

Let us go through a few propositions.

- Tajmahal is spectacular.
- A.P.J. Abdul Kalam is the author of Wings of fire.
- Sachin Tendulkar is a cricketer.
- All mobile phones are electronic devices.



Activity 3

Observe the subject and predicate of these propositions.

Are they of the same type?

Note down your observations regarding the subject and predicate of the above propositions.

These four propositions are examples of four different kinds of simple propositions. A proposition that consists of a subject and a predicate that is attributed to the subject is called a simple proposition. They are:

- i. Subject- predicate proposition
- ii. Relational propositions
- iii. Class membership propositions
- iv. General propositions.

i. Subject -predicate Proposition

The proposition '*Tajmahal is spectacular*' is a type of simple proposition, wherein, the subject is that of which an attribute is predicated. '*Taj Mahal*' is the subject of which 'being spectacular' is predicated. Such types of propositions are called subject-predicate propositions. Thus we can say that ***a proposition that asserts a quality or an attribute that belongs to something is a subject - predicate proposition.*** The predicate term simply qualifies the subject term. Nothing more about the subject is predicated here. In such propositions predicate may be an adjective.

ii. Relational Proposition

The proposition '*A.P.J. Abdul Kalam is the author of the book Wings of Fire*' is a type of simple proposition. Here the subject term and predicate term establish a relationship between each other. The subject term '*A.P.J. Abdul Kalam*' asserts a

relation of authorship with the book 'Wings of Fire'. ***A proposition that asserts a relation between constituent terms is called a relational proposition.***



Relational Statements

There are various words in ordinary use that express relations e.g. the transitive verbs (build, play, love etc.); words expressing equalities, inequalities and degrees in any respect (greater than, smaller than, equals, matches etc.); words expressing measurement (e.g. of heat).

The following are examples of relational propositions although they are not in strict logical form.

- Shajahan built Tajmahal.
- The value of a triangle equals two rectangles.
- The culture of North Indians differs from that of the South Indians.

It has been found convenient to use special names to distinguish relational propositions according to the number of terms involved. They are:

- Dyadic relation (two-termed relation)
- Triadic relation (three-termed relation)
- Tetradic relation (four-termed relation)
- Pentadic relation (five-termed relation)
- Polyadic relation (more than five-termed relation)

These are very important in mathematics and metaphysics. But the logical technique required for dealing with them is difficult. So cannot be treated in an elementary manner.

iii. Class Membership Propositions

The proposition 'Sachin Tendulkar is a cricketer' is a type of simple proposition. Here the subject is a member of a class indicated by the predicate term. The subject term 'Sachin Tendulkar' is said to be a member of a class of 'cricketers'. ***A proposition which asserts that something/somebody is a member of a given class is called a class membership proposition.***

IV. General Propositions

'All mobile phones are electronic gadgets' is simple proposition. In such proposition we find the relation of different classes. In the above proposition the subject term refers to a class of objects 'mobile phones' and the predicate term refers to another class of objects 'electronic gadgets'. So, a general proposition is **a proposition which asserts that one class is wholly or partly included in or excluded from another class**. A general proposition, therefore, makes an assertion about *all* or about *some* of the members of a class.

Let us check



Write SP if the following is a subject-predicate proposition, RP if it is a relational proposition, CP if it is a class-membership proposition and GP if it is a general proposition.

- Child labour is a crime.
- All farmers are contributors to the wealth of nation.
- Tsunami is catastrophic.
- Aristotle was the tutor of Alexander the Great.

Distinction between class membership and general propositions



Friedrich Ludwig
Gottlob Frege

It is important to distinguish the propositions 'Sachin Tendulkar is a cricketer' or 'Justin Beiber is a singer' (Class membership) from such propositions as 'All cricketers are sportsmen' or 'Some singers are Indians' (General). They are fundamentally in different logical forms. The distinction between the two logical forms, class-membership proposition and general proposition was first stated by a German logician Frege around 1879, and little later independently by an Italian logician Peano.

Friedrich Ludwig Gottlob Frege (1848-1925) was a German mathematician, logician and philosopher. He made major contributions to mathematics. He is generally considered to be the father of analytic philosophy.

Giuseppe Peano (1858 -1932) was an Italian mathematician. He wrote over 200 books and papers. He was one of the founders of mathematical logic and set theory. The standard axiomatization of the natural numbers is named 'the Peano axioms' in his honor.



Giuseppe Peano

B. Compound Proposition

Let us analyse the following propositions.

- If you eat few suppers, then you will need few medicines.
- The price of fuel is high and the price of commodities is high.
- Blackberry is either a mobile phone or a fruit.
- A student is not both a hosteler and a day scholar at the same time.



Activity 4

What differences do you notice between these propositions and simple propositions?

Note down your findings.

i. Conjunctive Proposition

In the proposition '*The price of fuel is high and the price of commodity is high*' we can find two simple propositions: (1). '*The price of fuel is high*' and (2) '*The price of commodity is high*'. The two propositions are joined by 'and'. The word 'and' is a conjunctive. The constituent propositions are called 'conjuncts'. **A compound proposition in which the simple propositions are combined by the conjunctive 'and', is called a conjunctive proposition.**

ii. Implicative Proposition

'*If you eat few suppers then you will need few medicines*' is a kind of compound proposition. Two simple propositions '*You eat few suppers*' and '*you will need few medicines*' are joined by the words '*If ...then*' to make a single proposition. **A compound proposition in which simple propositions are combined by 'If ... then' is called an implicative proposition.** In an implicative proposition one of the constituent propositions *implies* the other. The constituent part that consists of the word 'If' is called the '*implicans*' and that consists of the word '*then*' is called '*implicate*'.

iii. Alternative Proposition

'*Blackberry is either a mobile phone or a fruit*' is a kind of compound proposition. There are two constituents in this proposition. They are '*Blackberry is a mobile phone*' and '*blackberry is a fruit*'. They are connected using the words '*either...or*'. **A compound proposition in which the simple propositions are combined by 'either...or' is called an Alternative Proposition.** The components of the alternative proposition are called 'alternates'.

Disjunctive Proposition

The proposition ‘*a student is not both a hosteler and a day scholar at the same time*’ is a kind of compound proposition. ‘A student is a hosteler’ and ‘a student is a day scholar’ are the two constituent propositions. The connecting link of these constituents is ‘not both...and...’. The components of the disjunctive proposition are called the disjuncts. **Thus a disjunctive proposition is a compound proposition in which two simple propositions are combined by the words ‘not both...and ...’ in a particular manner.**

Let us check



Identify examples for compound propositions from life situations.

- A man is not both married and bachelor at the same time.
-
-
-

Disjunctive
.....
.....
.....

Complete the flow-chart.

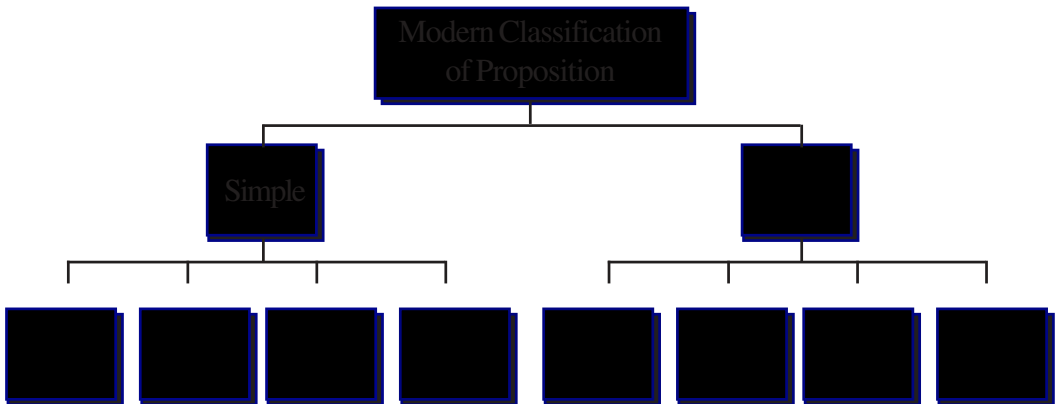

Distribution of Terms in Categorical Proposition

In traditional schedule the subject and predicate of every proposition were regarded as classes. The proposition ‘*All scientists are intelligent*’ is about relation between the classes ‘scientists’ and ‘intelligent men’. If the reference is to the whole of the class, the subject or the predicate is said to be ***distributed***. If the reference is to the part of the class, the subject or the predicate is said to be ***undistributed***.



Activity 5

Analyse the following scheme of distribution in A, E, I and O Propositions.

Proposition	Subject	Predicate
A	Distributed	Undistributed
E	Distributed	Distributed
I	Undistributed	Undistributed
O	Undistributed	Distributed

Derive conclusions.

- The are distributed in universal propositions.
-
-
-

These considerations may be summarised in the mnemonic *Asebinop*, which means A distributes Subject only, E both, I neither, and O predicate only.

Euler's Circles

Euler represented the relation between S and P in categorical propositions diagrammatically by means of circles. Hence there are four diagrams corresponding to the four types of proposition - A,E,I,O.

Leonhard Euler



(OY-ler; (1707–1783) was a pioneering Swiss mathematician and physicist. He made important discoveries in fields as diverse as infinitesimal calculus and graph theory. He also introduced much of the modern mathematical terminology and notation, particularly for mathematical analysis, such as the notion of a mathematical function.

A proposition

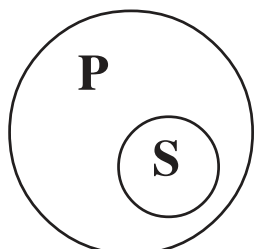

Figure 1

Fig. 1 stands for the A proposition. In an A proposition the class of things denoted by the subject is included in and forms part of the class denoted by the predicate. When we say 'All men are mortal beings' the class of 'men' is meant to fall entirely within the class of 'mortal beings'. The bigger circle stands for the denotation of the predicate term 'mortal beings' and the smaller circle for the denotation of the subject term 'men.'

E proposition

In the E proposition the circles representing S and P fall outside each other (see Fig. 2). The proposition E states that the class denoted by the subject is entirely outside the class denoted by the predicate. When it is said '*No men are perfect beings,*' it is meant that the class of men is completely outside the class of perfect beings. The circles never meet.

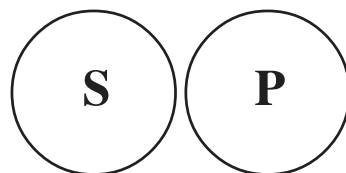

Figure 2

I proposition

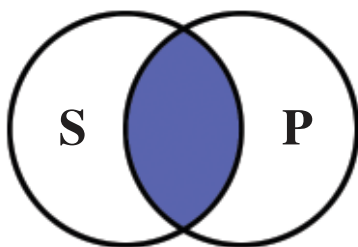

Figure 3

Fig. 3 represents the proposition I. The two circles intersect or overlap each other. When we assert '*Some men are wise*' we mean that a portion of mankind is identical with a portion of the class of wise beings. The proposition refers only to those beings that are both men and wise; the common segment of the two circles in the figure.

O proposition

The O proposition is interpreted in terms of circles by Fig. 4. Though the form of the figure is the same as that of Fig. 3, the O proposition does not tell us anything about the common segment. It gives us information only about the outer part of the circle representing S. When we assert '*Some men are not honest,*' we exclude the subject from the class denoted by the predicate; we refer only to that part of mankind which falls entirely outside the class of honest people.

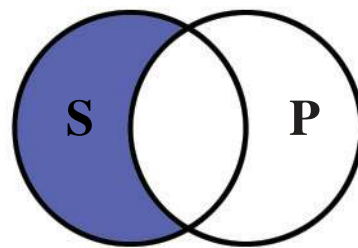

Figure 4

Reduction of Sentences to Logical Form

A beginner in logic must acquire the skill to reduce sentences to logical form. The hints below will help accomplish this task:

1. The sentences which combine two or more propositions must be **split into simple propositions.**

Example:

Gold and silver are precious metals.

=

(A) All gold things are precious metals.

(A) All silver things are precious metals.

2. The sentences with the words '**alone,**' '**only,**' '**none but,**' and '**none except**' are reduced to universal propositions.

Example:

Graduates **alone** are eligible.

Only Graduates are eligible.

None but Graduates are eligible.

None except Graduates are eligible.

=

(A) All Graduates are eligible.

Or

(E) No non-graduates are eligible.

3. The sentences with the words like '**unless,**' '**except,**' '**but,**' etc. are reduced to particular propositions.

Example:

All metals **except** one are solid.

=

(I) Some metals are solid.

Reducing compound sentences



We come across sentences which combine two or more propositions. Such compound propositions are called **exponible** by the mediaeval logicians. When reducing them to logical form they must be split into simple propositions as in example 1.

In some propositions the subject is limited by words like 'alone,' 'only,' 'none but,' 'none except,' 'none who is not,' e.g. 'Graduates alone are eligible.' There are two ways of reducing such propositions to logical form: (a) by inverting the subject and the predicate of the given proposition, an A proposition may be formed. 'All those who are eligible are graduates.' (b) by taking the contradictory of the given subject as the subject and with the same predicate an E proposition can be constructed. E.g. 'No non-graduates are eligible.' In exceptive propositions the predicate is asserted of the whole subject with the exception of certain cases. The application of the predicate is cut off from a portion of the subject by such words as 'unless,' 'except,' 'but,' etc. If the exceptions are definitely known, such propositions are regarded as universal. E.g. 'All metals, except mercury are solid.' If the exception is indefinite, the proposition is treated as particular. E.g., 'All metals except one are solid' = 'Some metals are solid.'



4. Words like ‘**every,**’ ‘**each,**’ ‘**any,**’ when used with the subject, signify an **A proposition.**

Example:

- a. **Every** soldier fought valiantly.

=

(A) All soldiers are persons who fought valiantly.

- b. **Each** and every one of the students should study hard for examinations.

=

(A) All students are those who should study hard for examinations.

- c. **Any** classroom is a polling station in the election.

=

(A) All classrooms are polling stations in the election.

5. Propositions with words like ‘**all,**’ ‘**every,**’ ‘**each,**’ ‘**any,**’ containing the sign of negation ‘not’ are generally regarded as **particular negative (I).**

Example:

- a. **All** that glitters is not gold.

=

(O) Some things that glitter **are not** gold.

- b. **Every** disease is **not** fatal.

=

(O) Some diseases **are not** fatal.

- c. **Any** excuse will **not** suffice.

=

(O) Some excuses **are not** those which will suffice.

6. The absence of any sign of quantity usually signifies a **universal proposition.**

Example:

Blessed are the pure in heart.

=

(A) All those who are pure in heart are blessed.

7. Propositions with words such as ‘**most,**’ ‘**a few,**’ ‘**certain,**’ ‘**many,**’ ‘**almost all,**’ ‘**all but one,**’ ‘**several**’ are **particular.**

Logic and Reasoning

Example:

a. **Most** of the legislators did **not** attend the meeting.

=

(O) **Some** of the legislators are **not** those who attended the meeting.

b. **A few** students have prepared their lessons.

=

(I) **Some** students are those who have prepared their lessons.

c. **Certain** animals are poisonous.

=

(I) **Some** animals are poisonous.

8. Propositions containing words like '**mostly,**' '**generally,**' '**frequently,**' '**often,**' '**perhaps,**' '**nearly**' '**always,**' '**sometimes**' are **particular**.

Example:

a. Indians are **mostly** literates.

=

(I) **Some** Indians are literates.

b. Students sometimes engage in extra-curricular activities.

=

(I) **Some** students are those who engage in extra-curricular activities.

9. Sentences beginning with the word '**few**' are to be reduced to particular negative.

Example:

a. **Few** books on logic are easy to read.

=

(O) **Some** books on logic **are not** easy to read.

b. **Few** persons are **not** selfish.

=

(I) **Some** persons **are** selfish.

10. Sentences with words like '**seldom,**' '**hardly,**' '**scarcely**' should be reduced to **particular**.

The word '**few**' means 'not many' and its logical equivalent is 'some not.' Thus a sentence beginning with the word '**few**' and not containing any sign of negation is to be treated as an O proposition; and if it contains a sign of negation, it should be regarded as an I proposition, since two negatives have the force of an affirmative.



Example:

- a. Unasked advice is **seldom** accepted.
= (O) **Some** pieces of unasked advice **are not** accepted.
- b. Prosperous lawyers are **not seldom** honest.
= (I) **Some** prosperous lawyers **are** honest.

Words like ‘seldom,’ ‘hardly,’ ‘scarcely’ have a negative meaning. When they occur in sentences not containing any negative signs, those sentences should be reduced to O. But when they are found in sentences containing a sign of negation, the sentences should be reduced to I proposition.



Let us check



Let us see how the quotes at the beginning of the unit are reduced.

“Neither a borrower nor a lender be
For loan oft loses both itself and friend
And borrowing dulls the edge of husbandry.”

- No man is the one who should be a borrower. E
- No man is the one who should be a lender. E
-
-
-

Reduce the underlined sentences in the illustrated dialogues between father and his son and doctor and his patient into logical form. (Page 30)

- Dialogue between father and son.
-
- Dialogue between doctor and patient.
-

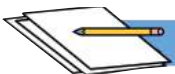

Summary

Proposition is the building block of logical reasoning. It is a logical sentence in ‘subject-copula-predicate’ form. But it is different from a grammatical sentence. Propositions are broadly classified in two ways. (1)The traditional classification consists of four categorical propositions and two conditional propositions. (2)The modern classification includes simple and compound propositions. In categorical proposition subject and predicate are either distributed or undistributed. Euler’s circle illustrates the distribution of terms in A,E,I and O propositions. The ordinary sentences can be transformed to logical sentences using ‘S is P’ format.

Proposition at a Glance

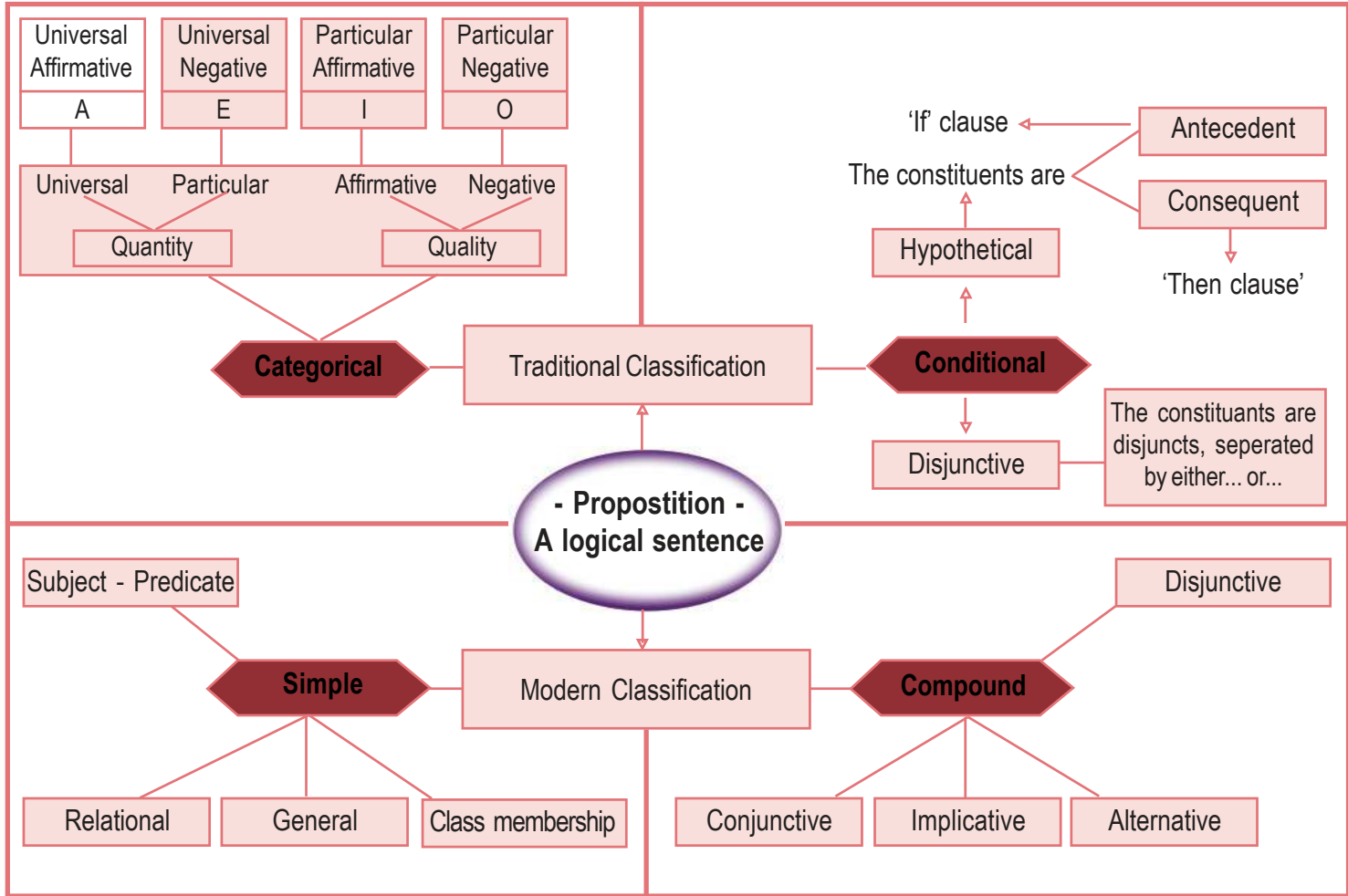



I can

- distinguish between logical proposition and ordinary language sentence.
- identify the limitations of ordinary language.
- classify proposition.
- construct propositions out of daily life situations.
- illustrate distribution of terms using circles.
- form propositions from ordinary language sentences.

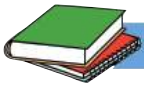

Let us assess

Exercise 1

1. Here are four news headlines from a daily. Identify the logical proposition among them.
 - a. India to overtake China as the world's most populous country by 2050.
 - b. Kudamkulam Nuclear Power Plant becomes operational.
 - c. Rithy Panh is Asian filmmaker of the year.
 - d. Indo-Russian joint military exercise 'INDRA2013' kicked off in Rajasthan.
2. The structure of a categorical proposition is _____.
 - a. Subject-verb-object
 - b. Subject-verb-predicate
 - c. Subject –copula-predicate
 - d. None of the above
3. Identify the subject, copula and predicate from the given categorical proposition. 'Some scientists are not humanitarian.'
4. Conjunct : conjunctive proposition, disjunct : disjunctive proposition. If so, antecedent and consequent : _____.
 - a. simple proposition
 - b. hypothetical proposition
 - c. class membership proposition.
 - d. general proposition.

Logic and Reasoning

5. Find out the class membership proposition from the following.
 - a. If you destroy forest then you destroy our planet.
 - b. Tajmahal is spectacular.
 - c. Aristotle was the tutor of Alexander the Great.
 - d. Kathakali is a classical art form of Kerala.
6. Choose the diagram that represent Particular Affirmative proposition.

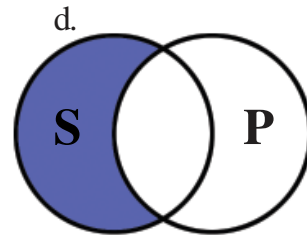
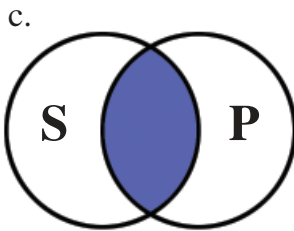
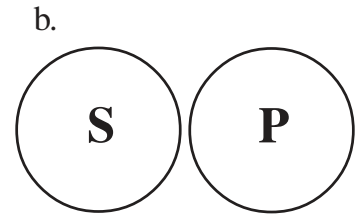
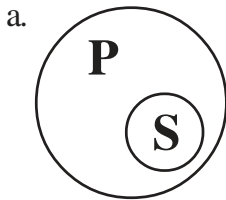

Questions 7-10: Each of the questions has an ordinary sentence followed by two logical propositions I and II. Consider the ordinary sentence and logical propositions. Decide which of the propositions follows from the sentence. Write answer a-d in the space.

- a) If proposition I follows
 - b) If proposition II follows
 - c) If neither proposition follows
 - d) If both the propositions follow
7. **Ordinary sentence** : Graduates alone are eligible.
Logical propositions :
- I. All graduates are eligible.
 - II. No non-graduates are eligible.

8. Ordinary sentence : Indians are mostly literate.
 Logical propositions :
- I. All Indians are literate.
 II. Some Indians are literate.
9. Ordinary sentence : A few students have prepared their lessons.
 Logical propositions :
- I. All students are those who prepared their lessons.
 II. No students are those who prepared their lessons.
10. Ordinary sentence : Unasked advice is seldom accepted.
 Logical propositions :
- I. No pieces of unasked advice are accepted.
 II. Some pieces of unasked advice are accepted.

1. The passages given below are from a newspaper.
 Reduce the under lined sentences in to logical form.



The pineapple is a highly popular tropical fruit. The plant grows to a height of 3 or 4 feet and has a crown of spiky leaves. The pineapple is a fruit of the summer season. It is abundantly found in all south_tropical countries.



A seagull can drink salt water because it has special glands that filter out the salt.



Kangaroo rats never drink water. Like their relative, the pocket mouse, they carry their own water source within them, producing fluids from the food they eat and the air they breathe.

-
-
-
-
-

Exercise 2

1. Prepare a seminar report on the topic 'ordinary language sentences and logical propositions.'
2. Prepare a chart showing the classification of proposition.
3. Illustrate the distribution of terms using Euler's circle and explain.
4. Compare hypothetical propositions and implicative propositions in traditional and modern classification respectively.

3

INFERENCE

KEY CONCEPTS

- Definition of inference
- Mediate and immediate inferences
- Opposition of propositions
- Square of opposition
- Types of opposition
- Immediate inference
- Kinds of immediate inference

In this chapter we learn inference as a mental process of arriving at a conclusion from known propositions. Induction and deduction are inferential processes. This chapter focuses on different kinds of immediate inference and their differences with mediate inference, which will be discussed in detail in the next chapter.



What does Sherlock Holmes try to communicate through this dialogue?

What is more important - to see or to reason? Discuss and share.

We always want a reason to believe in something. In the first chapter, we have come across reasoning. Inference is a process through which we prove that our argument is reasonable. It is the mental process of arriving at a new conclusion from known propositions. It is called argument. An argument consists of one or more propositions and a conclusion. Given propositions are known as premises and inferred proposition is called conclusion. Premises claim to provide evidence for conclusion.



Activity 1

Look at the picture and predict the conclusions.



-
-
-

The mental process used to arrive at the above conclusions is inference. So it is the process of deriving a new proposition from known propositions.

Inference is divided into deduction and induction.

Look at the following examples.

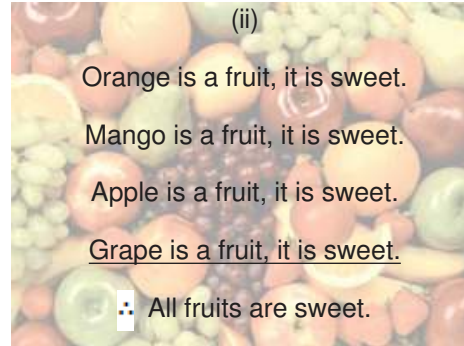
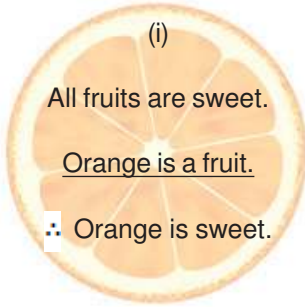

The first example is deductive inference. It is a process of arriving at a conclusion from general to particular. The second example is inductive inference. It is a process of arriving at a conclusion from particular to general. There is a detailed study of induction in chapter 6.

Look at the following sentences.

Instance (i)

No chocolates are bitter.

∴ No bitter things are chocolates.

Instance (ii)

All chocolates are tasty.

No bitter things are tasty.

∴ No bitter things are chocolates.

Both instances arrive at conclusion through different steps. In the first instance we reached the conclusions from a single proposition. The inference in which a conclusion is drawn directly from one proposition is called **immediate inference**. In the second instance, a conclusion is drawn from two given propositions. Such inference is known as **mediate inference**. We will study more about mediate inference in chapter 4.

Immediate inference is again classified into **Eduction** and **Opposition**. Let us study them in detail.

The Opposition of Proposition

In ordinary sense the word opposition means different. Example, the words 'ability' and 'disability' oppose each other. In logic **opposition means the relation between two propositions having same subject and predicate but differ in quantity, quality or in both.**



Activity 2

Change the quantity, quality and both of the following categorical propositions.

- All tobacco products are injurious to health.
-
-
-

Square of Opposition

These relationships can be illustrated by placing the four basic propositions A, E, I and O against one another (for the purpose of comparison) in a diagram. This is called the square of opposition.

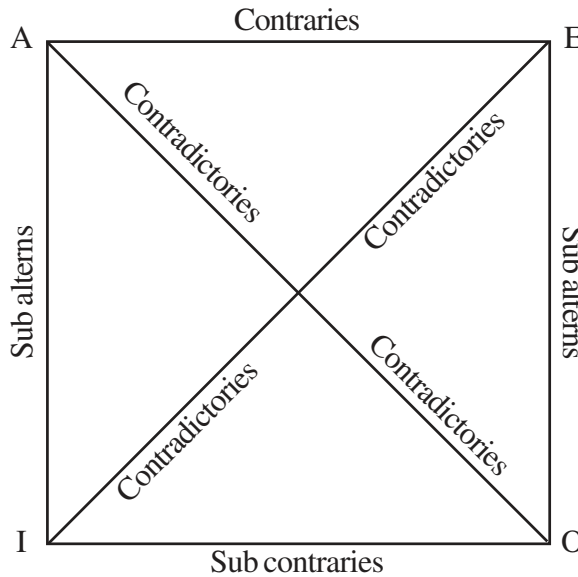

The relationships thus exposed by the square of opposition are four in numbers.

It is clear from the diagram that there are four ways in which propositions may be opposed.

- 1) Contradictory
- 2) Contrary
- 3) Sub contrary
- 4) Sub altern

Contradictory



Activity 3

Identify the differences between the given propositions

- All exams are easy.
- Some exams are not easy.
- No fruits are sour.
- Some fruits are sour.



Among the propositions one is the denial or negation of the other. **Two standard forms of categorical propositions that have the same subject and predicate terms but differ from each other both in quality and quantity are contradictories.** It is the relation between A & O and E & I propositions.

Of the contradictories exactly one is true and the other is false. They cannot both be true or they cannot both be false. In contradiction, if universally true, particular must be false and vice versa.

Let us check



Frame contradictory of the given proposition and find their truth and falsity.

- a) All elephants are black. A
 O
 If A is True, O is
- b) No lions are cruel. E
 I
 If E is false, I is

Contraries

Let us analyse and identify the difference between the propositions given below.

- (i) a) All football players are athletes.
 b) No football players are athletes.
- (ii) a) No planets are stars.
 b) All planets are star.

Both sets of given propositions are universal. **Universal propositions having the same subject and predicate terms but differ only in quality are contraries.** This relation exists between A & E propositions.

The conditions of contrary propositions are that they cannot both be true i.e. the truth of one ensures the falsity of the other. But both may be false.

Let us check



Find the truth or falsity of the given propositions

- | | | | |
|------|----|----------------------------|---|
| (i) | a) | All lions are carnivorous. | A |
| | b) | No lions are carnivorous. | E |
| | | If A is true, E is | |
| (ii) | a) | No planets are inhabited. | E |
| | b) | All planets are inhabited. | A |
| | | If E is false, A is | |

Sub contrary

Look at the following propositions.

- Some diamonds are precious stones.
- Some diamonds are not precious stones.

Here both the propositions are particular. **Particular propositions having the same subject and predicate but differing in quality are sub contraries.** It is the relation between I & O propositions.

The conditions of sub contraries are, if one is true, the other is doubtful. If one is false, the other must be true. Both may be accepted, but both cannot be rejected.

In other words:

- If I is true, O is doubtful.
- If I is false, O must be true.
- If O is true, I is doubtful.
- If O is false, I must be true.

Let us check



Frame the sub contrary of the given false propositions and find their truth and falsity.

- Some plants are mammals.
- Some TV channels are not media.

Sub alternation



Activity 4

Identify the difference between the propositions given below.

- a) All politicians are idealists.
Some politicians are idealists.
- b) No Indians are Europeans.
Some Indians are not Europeans.

The propositions have same subject and predicate but differ in quantity.

Two propositions having the same subject and predicate and quality but differ in quantity, is sub altern opposition. It exists between A & I and E & O propositions.

This opposition between a universal proposition and its corresponding particular proposition is known as sub alternation.

Conditions of Sub alternation are:

- If universal is true, particular must be true.
- If universal is false, particular may or may not be false.
- If Particular is false, universal must be false.
- If Particular is true, universal may or may not be true.

Let us check



Frame the sub altern of the given proposition and find their truth and falsity.

- | | | |
|----|-----------------------------|---|
| a) | No students are film stars. | E |
| | | O |
| b) | All animals are mammals. | A |
| | | I |
| | If E is false, O is | |
| | If A is true, I is | |

Sub alterns are called *corresponding propositions*. In such corresponding propositions universal is called super altern and the particular is called sub alternation.



Thus there are four ways in which propositions may be opposed. Relations exhibited by the square of opposition to provide the logical basis for validating certain elementary forms of arguments.

Other possible relations between propositions are :



- 1. Independence:** The true/false of one proposition does not permit an inference on the True/False of a second proposition.

e.g. Washington was the first President of the US.

President Lincoln was assassinated.
- 2. Equivalence:** Two propositions are equivalent if their truth values are identical.

eg: All democracies are forms of government that permit dissent.

All governments that do not permit dissent are non- democratic.
- 3. Sub-implication:** Two propositions are super-implicates if the falsity of the first requires the falsity of the second.

4. **Super-implication** : If the truth of the first requires the truth of the second and if the falsity of the first does not warrant an inference on the truth or falsity of the second. These true relations are illustrated as follows.

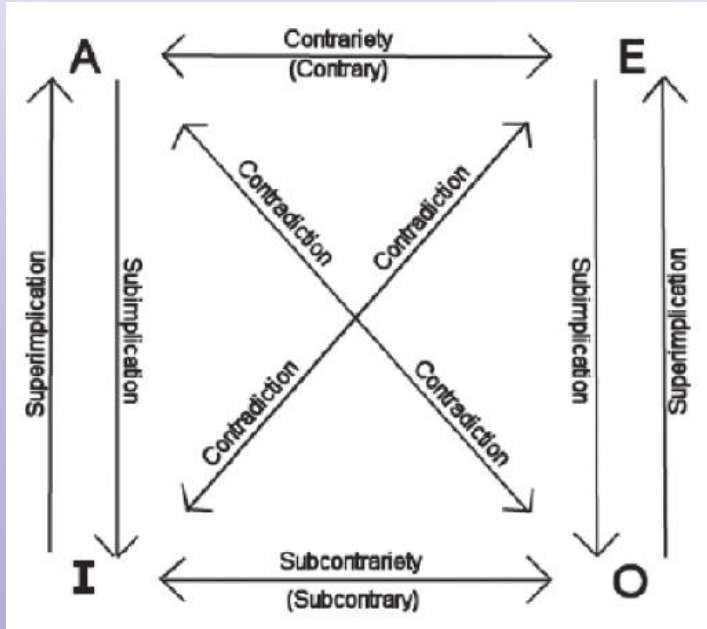
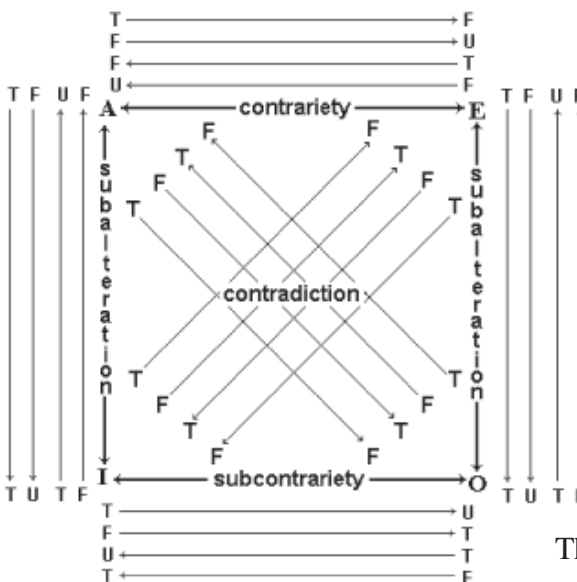

Table of Relations of Opposition

If T is true, F is false and U is doubtful try to complete the table in the next page.



The Square of Opposition

Given	SAP	SEP	SIP	SOP
SAP T		F		
SAP F				
SEP T				
SEP F	Doubtful			
SIP T				
SIP F				
SOP T				
SOP F				

Education

Education is an immediate inference in which we derive a new proposition as conclusion from a given proposition. The conclusion from a given proposition is transformed without affecting their meaning. **Conversion and obversion** are the main divisions of education.

The other educts are derived by the repeated alternate application of these two methods. **They are obverted converse, partial and full contra position and partial and full inversion.**



The process of education or immediate inference is based on the class view of the import of propositions, i.e. the subject and predicate of a proposition are to be taken in their extent. The relation between the two is to be regarded as one of inclusion or exclusion.

Conversion

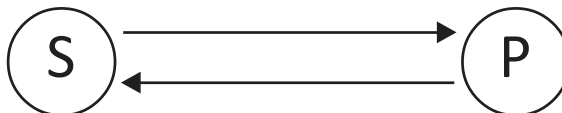

We convert S-P proposition into a P-S proposition. To convert a proposition is to interchange subject and predicate in accordance with the laws of logic. The original proposition is called *convertend*. The proposition obtained is called the *converse*.

Rules for Conversion

1. Interchange subject and predicate.
2. Quality remains the same.
3. No term should be distributed in the converse unless it is distributed in the convertend.

The conversion is as follows.

Convertend

SAP \longrightarrow
All fishermen are brave.

SEP \longrightarrow
No elephants are carnivores.

SIP \longrightarrow
Some drivers are careless.

SOP

Converse

PIS
Some brave men are fishermen.

PES
No carnivores are elephants.

PIS
Some careless persons are drivers.

No converse.

Let us check



Convert the following propositions.

- All farmers are hardworking.
- Some plants are extinct.
- No squares are circles.

'O' proposition has no converse.

When 'O' proposition is converted we have to interchange S and P. Then SOP becomes POS. Here subject of the convertend (SOP) is undistributed. So it cannot be distributed in the converse (POS). Therefore, conversion of O proposition leads to the violation of the third rule. So, O proposition has no converse.

There are two kinds of conversion. They are **simple conversion** and **conversion by limitation**.

a) Simple Conversion

Let us check 

Try to convert the following propositions.

- No robots have brain.
- Some humans are rational.

Here when E and I propositions are converted we get the same propositions as converse.

It is the direct transportation of subject and predicate without any change in the meaning and truth of the proposition. This type of conversion is simple conversion.

SEP \longrightarrow PES

SIP \longrightarrow PIS

b) **Conversion by limitation or per accidens** is applied to A proposition. In this process A proposition loses its universality and becomes I proposition.

When A proposition is converted by limitation it yields proposition I as a result (PIS).



Activity 5

Discuss in group and findout whether there is any fallacy in converting SAP to PAS?

Substantiate your response.

Let us see an exception to the above rule.

Singular proposition are considered as universals. If in an affirmative proposition both the terms are singular, conversion may be made without limitation. Thus '*Mount Everest is the highest peak in the world*' is converted into '*the highest peak in the world is the Mount Everest*'. If in an affirmative proposition the subject term is singular and the predicate terms is general, the conversion is made by limitation.

Obversion



The logical contradictory of a term is obtained by prefixing 'not' or 'non' to the term. But we may use instead such phrases as 'other than.' E.g. '*Some mistakes are not proofs of ignorance*' can also be written '*some mistakes are other than proofs of ignorance*'.

In obversion the quality of the proposition is changed. The predicate is replaced by its contradictory. From a proposition S-P, we infer a proposition S-nonP. Every proposition can be expressed either affirmatively or negatively. The original proposition is called the **obvertend** and the inferred proposition is called the **obverse**.

The rules of obversion are:

1. Keep the subject as it is.
2. Contradict the predicate.
3. Change the quality of proposition.

Obvertend

Obverse

SAP → SEP̄
All birds are feathered. No birds are non-feathered.

SEP → SAP̄
No birds are mammals. All birds are non-mammals.

SIP → SOP̄
Some elephants are Africans. Some elephants are not non-Africans.

SOP → SIP̄
Some vehicles are not three wheelers. Some vehicles are non-three wheelers.

Obverted Converse

By first converting the given proposition SP and then obverting, we get obverted converse. As it is already said that O proposition has no converse, it has no obverted converse as well.



Activity 6

- A. Original Proposition : All S is P
 Converse
 Obverted converse : Some S is not non P
- B. Original Proposition : No S is P
 Converse : No P is S
 Obverted converse :
- C. Original Proposition : Some S is P
 Converse :
 Obverted Converse :

Let us check



Find out the obverted converse of the following propositions.

- a) All scientists are wise.
- b) No thinkers are cowards.
- c) Some students are brave.

Contraposition (partial and full)

Contraposition is an immediate inference in which from a given proposition we infer another proposition having the contradictory of the original predicate (non-P) for its subject. When the predicate of the contraposition is the original subject (S) the contraposition is partial (non-PS). When the predicate is the contradictory of the original subject (non-S) the contraposition is full (non-P non-S).

The partial contraposition is derived by first obverting the given proposition and then converting its obverse. The full contraposition is derived by obverting the partial contraposition of the given proposition.



Activity 7

Let us check...

- | | | | |
|----|------------------------|---|--------------------|
| A. | Original proposition | : | All S is P |
| | Obverse | : | |
| | Partial contraposition | : | |
| | Full contra position | : | All non-P is non-S |
| B. | Original proposition | : | No S is P |
| | Obverse | : | All S is non-P |
| | Partial contraposition | : | |
| | Full contra position | : | |
| C. | Original proposition | : | |
| | obverse | : | Some S is non-P |
| | partial contraposition | : | |
| | Full contraposition | : | |
| D. | Original proposition | : | Some S is P |
| | Obverse | : | |

Is there contraposition for I proposition?

Substantiate.

Let us check...



Find partial contraposition and full contraposition (concrete) of the following.

- All astronauts are engineers.
- No shrubs are tall.
- Some students are smart.
- some robots are not intelligent.

Inversion (partial and full)

Inversion is an immediate inference of eduction in which from a given proposition we infer another proposition. Its subject is the contradictory of the original subject (non-S).

The inverse is partial when its subject is the contradictory of the original subject (non-S) and its predicate is the same as the original predicate (P).

Logic and Reasoning

Partial inverse SP ——— $\bar{S}P$

The inverse is full when its predicate is also the contradictory of the original predicate (non-P).

Full Inverse SP ——— $\bar{S} \bar{P}$

Only universal propositions A and E have inverse. The particular proposition I and O have no inverse. In the case of A we have to begin with obversion and in the case of E, with conversion.



Activity 8

Complete the following.

- | | | | |
|---|-----------------------|---|---------------------|
| A | Original proposition | : | All S is P |
| | Obverse | : | |
| | Conversion | : | No non-P is S |
| | Obversion | : | |
| | Full inverse | : | Some non-S is non-S |
| | Partial inverse | : | |
| E | Original proposition: | | No S is P |
| | Conversion | : | |
| | Obversion | : | All P is non S |
| | Partial inverse | : | |
| | Full inverse | : | |

Let us check



Discuss in group and identify A and E proposition and find out their inverse.

Let us think and complete the scheme of education



Let us check

Given	Conversion	Obversion	Obverted	Partial	Full	Partial	Full
Prop.			converse	contraposition	contraposition	inverse	inverse
SAP							
SEP							
SIP							
SOP							



Summary

Inference is a process in which we arrive at a conclusion from given propositions. There are mediate inferences and immediate inferences. We get knowledge regarding the relation between propositions through opposition of proposition. Immediate inference is a process in which we arrive at a conclusion from one given proposition. It is also known as eduction. There are two immediate inferences - Obversion and Conversion. Other educts are obverted converse, contraposition and inversion.



I can

- distinguish between different categorical propositions.
- infer one proposition from another.
- infer the truth and falsity of propositions.
- distinguish between mediate inference and immediate inference.
- pass on from one proposition to another.



Let us assess

Exercise -1

1. If O is T, A is.....(true, false, doubtful)
2. If A is T, I is.....(True/False/Doubtful)
3. If E is T, O isand I is(True/False/doubtful)
4. If O is true and , then A is(true, false, doubtful)
5. If A is false, then O isand (true, false, doubtful)

Exercise -2

1. If I is T, then A is.....and O is
2. If O is F, E isand A is
3. If E is F, O isA isand I is
4. If I is F, E isand A is
5. If A is F, I is, E is, and O is

Exercise 3

Are the following correct or incorrect?

1. If it is true that some apples are green, then it is false to say that no apples are green.
2. If it is False to say that some apples are not green, it is False to say that some apples are green.
3. If it is true to say that some apples are green, it is true to say that every apple is green.
4. If it is false to say that no apple is green, whether some apples are green is unknown.
5. If it is to say that some apples are green, it is unknown whether every apple is green.

Excercise 4

What is the type of opposition between the following pairs? Given the first of each pair as true, what can be said of the truth and falsity of the second?

1. Some fears are rational.
No fear is rational.
2. All anecdotes are misleading.
No anecdotes are misleading.
3. No man has a heart of stone.
Some men do not have heart of stone.

Exercise 5

Convert the following.

1. Some cats are ferocious.
2. No wise man is reckless.
3. All courageous men are confident.
4. Some crystals are costly.

Exercise 6

Obvert the following.

1. All sciences are organized.
2. All roses are red.
3. No angels are lovers of peace.
4. Some legends are not incredible.
5. Some trash is flammable.
6. No animals are moral.

Logic and Reasoning

Exercise 7

Find the obverted converse of following.

1. All stars are bright.
2. No students are cowards.
3. Some women are angels.
4. All historians are archaeologists.
5. Some philosophers are jovial.

Exercise 8

Find the contraposition (Full / Partial) of the following.

1. Some orators are thinkers.
2. No men are drunkards.
3. Some flowers are not beautiful.
4. All children are innocent.

Exercise 9

Find the Inversion (Full / Partial) of the following.

1. All students are confident.
2. No seeds are trees.

Exercise 10

The proposition '*All cell phones are wireless devices*' can be stated as.

1. Some wireless devices are cell phones.
2. Some cell phones are wireless devices.
3. All non wireless devices are non cell phones.
4. No wireless devices are non cell phones.
5. Some non cell phones are not wireless devices.

Choose the best response (a-d)

- a. 1, 2 and 4 are true.
- b. 1, 3 and 4 are true.
- c. 3, 4 and 5 are true.
- d. 1, 3 and 5 are true.

Exercise 11

Construct A, E, I and O propositions and find their obverse.

4

SYLLOGISM

KEY CONCEPTS

- Syllogism - meaning and definition
- Structure of syllogism
- Kinds of syllogism
- Categorical syllogism
- Standard form of categorical syllogism
[Figure and mood of a syllogism]
- Rules and fallacies of categorical syllogism
 - Rules relating to structure
 - Rules relating to quantity
 - Rules relating to quality
- Mixed syllogism
- Hypothetical syllogism, disjunctive syllogism and dilemma

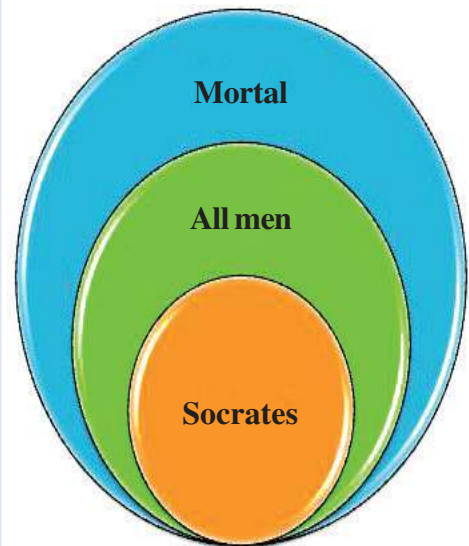

This chapter discusses the mediate inference Syllogism. We learn to construct different kinds of syllogisms following the respective rules. We can also detect the fallacies in our arguments.



In the above conversation, the third proposition is implied in the first two propositions.

If the first two are true, then the third one is necessarily true.

What is syllogism ?

(Meaning and Definition)

We studied in the last chapter that there are two types of inferences i.e. mediate and immediate. Mediate inference is also called syllogism. Mediate inference is the process by which we arrive at a conclusion from two given propositions. These propositions are also called premises.

Syllogism is collecting together of two propositions. Aristotle calls this inferential process as syllogism. That is, thinking together - thinking two propositions together.



In Mathematics the different propositions are internally related. The truth of the subsequent follows from the truth of the precedents.

$$(9+3) \div (2+2)$$

$$12 \div 4$$

$$= 3$$

Let us consider the earlier conversation among students.

Sree Narayana Guru is a social reformer.

All social reformers are virtuous.

∴ *Sree Narayana Guru is virtuous.*

The first two propositions do imply the third and if the first two were true, the third would necessarily be true. This is an example of syllogism. **Thus syllogism can be defined as the deductive argument in which the conclusion is inferred from two premises.**



Jevons defined syllogism as “the act of thought by which from two given propositions we proceed to a third proposition, the truth of which necessarily follows from the truth of these given propositions.”



*William Stanley Jevons
(1835-1882)*



Aristotle (384 - 322 BC)

According to Aristotle “a syllogism is a discourse in which certain things being stated, something other than what is stated follows of necessity from their being so.” Aristotle restricted syllogism to propositions of subject predicate form. The propositions are mainly categorical.

Structure of syllogism

Every pair of propositions will not lead to a conclusion. There must be some identity if two propositions are to lead to a third proposition. The two premises have a common term which is called the middle term. It is through the mediation of the middle term that the inference is drawn. So, this process is known as mediate inference.

The term that occurs as the predicate of the conclusion is called the **major term** of syllogism. The term that occurs as the subject term of the conclusion is called the **minor term** of syllogism. The third term of syllogism, which does not occur in the conclusion, but present in both the premises, is called the **middle term**. The premise in which the major term appears is called the **major premise**. The premise which contains the minor term is called the **minor premise**.

Logic and Reasoning

- e.g. All Indians are Asians
 All Keralites are Indians
 \therefore All Keralites are Asians

If we analyse the above example, the term 'Asians' is the major term, and the major premise is '*All Indians are Asians*'. The term 'Keralites' is the minor term, and the minor premise is '*All Keralites are Asians*'. In this example the term 'Indians' which does not appear in the conclusion is the middle term. The letters P, S and M are used to denote the Predicate and the Subject of the conclusion and the Middle term in the premises. In a standard form of syllogism, the major premise is stated at first, the minor premise second and the conclusion at last.

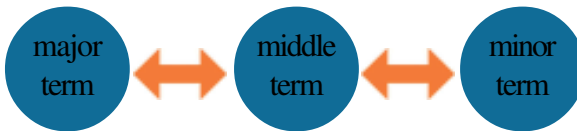

Indian Syllogism

We also have syllogistic argument in *Nyaya Darsana* of Indian philosophy. Here we have five proposition in an argument. Major term is known as *Sadya*. Middle term is known as *Hetu*. Minor term is known as *Paksha*.

Kinds of syllogism

There are two types of syllogism, pure and mixed. Each has three subdivisions. Pure syllogisms are pure categorical, pure hypothetical and pure disjunctive. Mixed syllogisms are hypothetical, disjunctive and dilemma.

In pure syllogism all the three propositions are of the same type, such as all categorical, all hypothetical and all disjunctive. Pure hypothetical and pure disjunctive type of argument is not common. Therefore we study only about categorical syllogism in the class of pure syllogism.

A mixed syllogism contains different kinds of propositions.

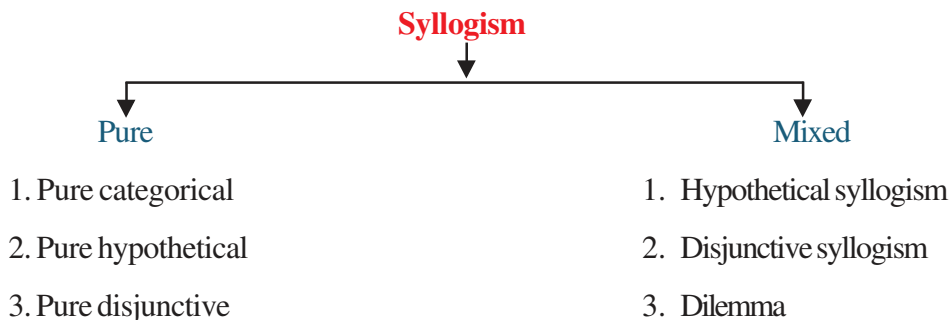

Categorical Syllogism

A categorical syllogism is defined as a deductive argument consisting of three categorical propositions which contain three and only three propositions. The first two propositions are premises, and the third one is the conclusion.

- e.g. No heroes are cowards.
Some soldiers are cowards.
 \therefore Some soldiers are not heroes.

Standard Form of Categorical Syllogism

Figure and moods of the syllogism

1. Figure

The figure of a syllogism is the form of a syllogism.



Activity 1

Let us check

Represent the following syllogism in symbolic form using the letters M P S.

- | | | |
|----|--------------------------------------------------------|------------------------------|
| 1. | No atheist goes to the temple. | M P |
| | <u>All materialists are atheist.</u> | S M |
| | \therefore No materialists go to the temple. | $\therefore \bar{S} \bar{P}$ |
| 2. | All gentlemen are polite. | |
| | <u>No gamblers are polite.</u> | |
| | \therefore No gamblers are gentleman. | \therefore |
| 3. | Some books are not edifying. | |
| | <u>All books are interesting.</u> | |
| | \therefore some interesting things are not edifying. | \therefore |
| 4. | All business men are self - confident. | |
| | <u>No self-confident men are coward.</u> | |
| | \therefore No coward beings are business men. | \therefore |

From the symbolic form, we can understand that the middle term (M) is placed in different positions. Without M no relation between S and P is possible. According to the position of M in both premises, there are four types of figures in categorical syllogism. The figure of a syllogism means the form of the syllogism as determined by the position of the middle term in two premises.

Logic and Reasoning

Figure 1

M P

S M

S P



Figure 2

P M

S M

S P



Figure 3

M P

M S

S P



Figure 4

P M

M S

S P



In first figure the middle term may be the subject term of the major premise and the predicate term of the minor premise. In second figure middle term may be the predicate term of both the premises. In third figure it may be the subject term of both the premises and in fourth figure it may be the predicate term of the major premise and the subject term of the minor premise.

Find out the four kinds of figure in the given picture

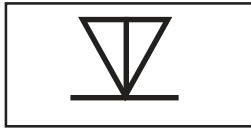

2. Mood

Syllogisms differ from one another in quality and quantity of the propositions. Mood is the arrangement of the propositions by quantity and quality. Of the four types of categorical propositions [A, E, I, O], each type can be used thrice in an argument. The mood of every syllogism is represented by three letters, in a scientific order. The first letter stands for the type of the major premise, the second letter for the type of minor premise and the third letter for the type of conclusion in a syllogism.

For instance if all three propositions of a syllogism are universal affirmative, then the mood of the syllogism is AAA.

All animals are carnivores. A

All tigers are animals. A

All tigers are carnivores. A



We can get 16 moods in each figure. So, there will be 256 moods. But all of them do not yield valid conclusions. There are only 19 valid moods. You can remember them easily by using the following expressions.

1. Barbara, Celarent, Darii, Ferio
2. Cesare, Camestres, Festino, Baroco
3. Darapti, Disamis, Datisi, Felapton, Bocardo, Ferrison
4. Bramantip, Camenes, Dimari's, Fesapo, Fresison

FIGURE 1

AAA BARBARA	EAE CLEANER	AII DARII	EIO FERIO
----------------	----------------	--------------	--------------

FIGURE 2

EAE CESARE	AEE CAMESTRES	EIO FESTINO	AOO BAROCO
---------------	------------------	----------------	---------------

FIGURE 3

AAI DARAPTI	IAI DISAMIS	AII DATISI	EAO FELAPTON	OAO BOCARDIO	EIO FERRISON
----------------	----------------	---------------	-----------------	-----------------	-----------------

FIGURE 4

AAI BRAMANTIP	AEE CAMENES	IAI DIMARIS	EAO FESAPO	EIO FRESISON
------------------	----------------	----------------	---------------	-----------------

**Activity 2**

1. Find out the mood.
FESTINO, CAMENES, FERIO
2. Construct syllogisms for CELARENT, FERRISON and FRESISON.

Rules and Fallacies of syllogism

Syllogism depends for its formal validity on certain conditions. These are called the rules or canons of the syllogism. Any given syllogism can be evaluated based on these rules.

If any one of these rules is violated, there will be an error in reasoning. This error is called fallacy. The violations of the syllogistic rules are generally called “Formal Fallacies” as they have to do with the form of the argument in question.



Violation of traffic rules

Rules of a syllogism

There are many rules for a standard form of syllogism. Of these, some rules are fundamental. They are those relating to the structure, quantity and quality of the syllogism. There are also supplementary rules.

A. Rules relating to structure

Rule 1

A syllogism must contain exactly three terms, each of which is used twice in the same sense throughout the argument.

There must be three terms in every valid syllogism. Any syllogism that contains more than 3 terms is invalid.

Fallacies

Violation of this rule may lead to two kinds of fallacies.

- a) Fallacy of four terms (*Quarternio-terminorum*) and (b) Fallacy of equivocation.

Fallacy of four terms: A syllogism containing four terms commits the fallacy of four terms.

For example :

The table touches the floor.

My arm is that which touches the table.

∴ My arm is that which touches the floor.

The four terms are, the table, that which touches the floor, my arm and that which touches the table.

Fallacy of equivocation: If a term is used in different senses in an argument, it commits the fallacy of equivocation.

The fallacy of equivocation may be called 'that of ambiguity' because the meaning or the sense of the term is not clear.



Activity 3

Find out the four terms

Ram is my friend.

Mohan is Ram's friend.

∴ Mohan is my friend.

If the major term is used in different senses

(ambiguously), the syllogism commits the fallacy of ambiguous major.

E.g. No courageous creature flies.

The eagle is a courageous creature.

∴ The eagle does not fly.

If the minor term is used in two different senses, the syllogism commits the fallacy of ambiguous minor.

E.g. No man is made of paper.

All pages are man.

∴ No pages are made of paper.

If the middle term is used ambiguously the syllogism commits the fallacy of ambiguous middle.

E.g. Power tends to corrupt.

Knowledge is power.

∴ Knowledge tends to corrupt.

Let us check



Find out which term is used in an ambiguous manner.

1. Brave does not run.

Ram is brave.

∴ Ram does not run.

2. Blue is a colour.

Sky is blue.

∴ Sky is a colour.

Rule 2

A syllogism must contain three and only three propositions.

A syllogism is an argument in which from two given propositions, we infer a third proposition. Hence, there must be only three propositions in a syllogism. This rule cannot be violated.

B. Rules relating to quantity (Rule of distribution of terms)

Rule 3

The middle term must be distributed at least in one premise.

This rule emphasises the importance of the middle term in a syllogism. The middle term is like a match maker that links the subject to the predicate. The middle term is related to each of the major term and minor term. Through this relation, it establishes the link between the minor term and major term as the subject and predicate of the conclusion. Since the middle term has the essential linking role, it must refer to all the members of the class in at least one of the premises.

Fallacy

If this rule is violated the syllogism commits the fallacy of the undistributed middle.

E.g. All Russians are revolutionaries.

All anarchists are revolutionaries.

∴ All anarchists are Russians.

Let us check

Find out the fallacy.

All students are intelligent.

Some intelligent beings are dolphins.

∴ Some dolphins are students.

Here the middle term 'intelligent' is not distributed in either premises. So it commits the fallacy of undistributed middle.

Rule 4

No term can be distributed in the conclusion, unless it is distributed in the premises.

The premises of a valid argument logically imply their conclusion. The conclusion cannot go beyond any more than what is contained in the premises. If it does so, the argument is invalid. It is an illicit process.

Fallacies

Violation of this rule may lead to two kinds of fallacies. They are (1) illicit major and (2) illicit minor.

Illicit major

When a syllogism contains a major term undistributed in the major premise but distributed in the conclusion, it commits the fallacy of illicit major.

E.g. All composers are singers.

No apes are composers.

∴ No apes are singers.

Here the term 'singers' is not distributed in the major premise but distributed in the conclusion and this leads to the fallacy of illicit major.

Illicit minor

When a syllogism contains a minor term undistributed in the minor premise but distributed in the conclusion, the syllogism commits the fallacy of illicit minor.

**Activity 4**

Find out the fallacy.

Some intelligent persons are wise.

No wise persons are kings.

∴ Some kings are not intelligent.

Logic and Reasoning

- E.g. All men are mortal.
- All men are intelligent.
- ∴ All intelligent beings are mortal.

The term ‘ intelligent is ‘ not distributed in the minor premise but is distributed in the conclusion and this leads to the fallacy of illicit minor.



Let us check

Find out the Fallacy.

All social workers are women.

All social workers are progressive.

All progressive beings are women.

C. Rules relating to Quality

Rule 5

From two negative premises, no valid conclusion is possible.

- E.g. No triangles are squares.
- No triangles are four sided.
- ∴ No squares are four sided.

From the fact that S and P are excluded from M, we can conclude that there is nothing as regards the relation to each other. The negative statements give us no ground for inference. At least one premise must be affirmative. Sometimes the premises may appear to be negative, while in reality they are not. In such cases a valid conclusion may be drawn.

Fallacy

Any syllogism that violates this rule is said to commit “ the fallacy of two negative premises.”



Activity 5

Give an example of the fallacy of two negative premises.

Rule 6

If one premise of a syllogism is negative, the conclusion must be negative and vice versa.

In a syllogism, where one premise is negative and the other affirmative, it is asserted that of the major and minor terms, one agrees and the other does not agree with the middle term. Therefore the major and minor terms do not agree to each other. Hence, the conclusion must be negative.

E.g. No men are perfect.
Ramu is a man.
 \therefore Ramu is not perfect.

Supplementary Rules**Rule 7**

From two particular premises, no conclusion is possible.

**Activity 6**

Make different combinations of particular propositions. Check the validity of these combinations.

II, —, —, —,

There are two particular propositions I and O. The possible combinations are II, IO, OI, OO. Let us examine each of them, one by one.

II: If the premises are II, i.e. particular affirmative no conclusion can be drawn. This is because an I proposition does not distribute any term. But Rule 3 says that the middle term must be distributed at least once. Hence, this combination commits the fallacy of undistributed middle. Therefore, no valid conclusion is possible.

IO and OI: The two premises together distribute only one term, i.e. the predicate of O. This term has to be the middle term as per rule 3. However, as one of the premises is negative, the conclusion must be negative. That means, its predicate, i.e. major term will be distributed in the conclusion, without being distributed in the premise. This will result in the fallacy of illicit major. Hence, no conclusion is possible.

OO - Two negatives: No conclusion can be drawn from two negatives. (rule 5.)

Rule 8

If one premise is particular, the conclusion must be particular.

Rule 7 holds that both the premises cannot be particular. Accordingly, if one premise be particular the other has to be universal. If this be so, the following are the combinations.

A I, I A, A O, O A, E I, I E, E O, O E. Out of these, E O and O E cannot give any conclusion. Because both the premises are negative. Take A I and I A combinations, only one term - the subject of A - will be distributed. This has to be the middle term, as per rule 3. Thus neither the major term nor the minor term (S or P) is distributed in the conclusion (Rule 4) as such. The conclusion can only be I as it neither distributes its subject nor predicate.

A I - All students are intelligent.

Some students are hard working.

∴ Some hard working beings are intelligent.

A O and O A : Here two terms will be distributed – the subject of A and the predicate of O. One of these will be the middle term (Rule 3). So, only one term can be distributed in the conclusion. Now, one of the premises being negative, the conclusion has to be negative. Only O is a negative proposition which distributes one term. Hence, the conclusion will be O, it is particular.

E I and I E : If these be the premises, two terms will be distributed (the subject and the predicate of E). Out of these two, one has to be the middle term. But only one term can be distributed in the conclusion. Further, as one of the premises is negative, the conclusion has to be negative (Rule 6). Accordingly, only O can be the conclusion as it is negative. Hence, if one of the premises is particular, the conclusion must be particular.

**Activity 7**

Find out the conclusion.

Some scientists are poets.

All poets are naturalists.

.....?

**Activity 8**

Find out the conclusion.

Some songs are not melodies.

All songs are rhythmic.

.....?

**Activity 9**

Find out the conclusion.

No birds are four legged.

Some animals are four legged.

.....?

Mixed syllogism

So far, we have discussed categorical syllogism. We now turn to syllogism of other kinds. A syllogism which contains propositions of the same kind is a pure syllogism. A syllogism may contain propositions that are not categorical. There are syllogisms in which the propositions are not of the same kind. They are known as mixed syllogisms.

There are three kinds of mixed syllogisms (1) Hypothetical (2) Disjunctive (3) Dilemma.

Hypothetical Syllogism

A Hypothetical syllogism is a kind of mixed syllogism. It has a hypothetical major premise, a categorical minor premise and a categorical conclusion.

A Hypothetical proposition consists of two parts – antecedent and consequent joined by ‘ if then ‘

E.g. If the rainfall is adequate, then the harvest will be good.

The rainfall is adequate.

∴ The harvest will be good.

If A is B, then C is D.

A is B.

∴ *C is D.*

Here, ‘*the rainfall is adequate*’ is the antecedent and ‘*the harvest will be good*’ is the consequent.

A valid hypothetical syllogism is possible only in two ways, i.e. either by affirming the truth of the antecedent or by denying the truth of the consequent. These are the two rules of a hypothetical syllogism. Applying these rules, we can get two types of hypothetical syllogisms. They are Modus Ponens and Modus Tollens.

Kinds of Hypothetical Syllogisms

1. **Modus Ponens or constructive Hypothetical syllogism:** It is one in which the minor premise affirms the antecedent and the conclusion affirms the consequent of the major premise. The form is -

If A is B then C is D.

A is B.

∴ C is D.

Logic and Reasoning

Example :

If Mohan works hard then he will pass the examination.

Mohan works hard.

∴ He will pass the examination.

Let us check 

Write Modus Ponens.

If Gopal works in society, then he will be rewarded. - -

2) **Modus Tollens or Destructive Hypothetical Syllogism :**

It is one in which the minor premise denies the consequent of the major premise.

On this basis the conclusion denies the antecedent of the major premise.

The form is:

If A is B, then C is D.

C is not D.

∴ A is not B.

E.g.

If a woman loses her husband, then she becomes a widow.

This woman is not a widow.

∴ This woman has not lost her husband.

Let us check 

Write Modus Tollens.

If Ram is a vegetarian, then he does not eat eggs. - -

Fallacies

There are two fallacies in hypothetical syllogism.

1. Affirming the consequent.

This fallacy happens when we affirm the consequent in the minor premise instead of the antecedent.

e.g. If the child is woken up, it will weep.

The child is weeping.

∴ The child is woken up.

Here, the minor premise affirms the consequent of the major premise. So the conclusion affirms the antecedent of the major premise. Thus it involves the fallacy of affirming the consequent.

2. Denying the antecedent.

This fallacy happens when we deny the antecedent instead of the consequent.

E.g: If I overeat, I will not become healthy.

I do not overeat.

∴

Here, the minor premise denies the major premise and on this basis, the conclusion denies the consequent of the major premise.

Disjunctive Syllogism

A disjunctive syllogism has a disjunctive major premise, a categorical minor premise and a categorical conclusion.

Rules

1. Affirm one alternative in the minor premise and deny the other in the conclusion.
Or deny one alternative in the minor premise and affirm other in the conclusion.
2. The two alternatives must be exclusive of each other, i.e. the presence of one implies the absence of the other.
3. The two alternatives must be exhaustive, i.e. the two alternatives taken together must cover the whole subject without omitting any part of it.

Kinds of Disjunctive Syllogisms

1. Modus Ponendo Tollens :

It is a mood which denies by affirming. An argument in which the minor premise affirms an alternative and the conclusion denies the other.

Either A is B or C is D.
A is B.
∴ C is not D.

E.g. Any numeral must be either odd or even.
This numeral is odd.
∴ It is not even.

Let us check



Write down the correct disjunctive syllogism.
A line is either straight or curved.

2. Modus Tollendo Ponens

It is the mood which affirms by denying. An argument in which the minor premise denies one alternative and the conclusion affirms the other.

Either A is B or C is D.
A is not B.
∴ C is D.

E.g. It is either a snake or a rope.
It is not a snake.
∴ It is a rope.

Let us check



Write Modus Tollendo Ponens.
Krishna is either a socialist or a democrat.
.....
.....

Fallacy of improper disjunction

Errors occur in disjunctive arguments also. Sometimes the alternatives are neither exclusive nor exhaustive.

E.g. Students are either intelligent or hardworking.

X is intelligent.

∴ X is not hard working.

This argument is invalid because the alternatives are not exclusive. There are students who are both intelligent and hard working.

Men are either rich or poor.

He is not rich.

∴ He is poor.

This is invalid. Here the alternatives are not exhaustive. There are average men, neither rich nor poor.

Dilemma



If you are the person in the picture how will you save yourself?

Discuss your idea with your partner. Present the best solution.

The dilemma is a double-grip reasoning which puzzles a man. It is a common form of argument in ordinary language. We may say that a person is in a dilemma when he has to choose between two alternatives both of which are equally unpleasant.

"Dilemma is a hypothetical argument offering alternatives and proving something against an opponent in either case." - (Dr. Ramnath Sarma)



In a dilemma, the major premise is a compound hypothetical proposition, the minor premise is a disjunctive proposition. The conclusion is either categorical or disjunctive.

The major premise is a combination of two hypothetical propositions. The minor premise is a disjunctive proposition. The two alternatives either affirm the antecedents or deny the consequents of the major premise. Accordingly, either the consequents of the major premise are affirmed or its antecedents are denied in the conclusion.

Form of a Dilemma

Dilemma can have four different forms. First, it can be simple or complex. If the conclusion is a categorical proposition, the dilemma is simple. If the conclusion is disjunctive, it is complex. Second, it can be either constructive or destructive. If the minor premise affirms the antecedents of the major premise, it is constructive and if it denies the consequent of the major premise, it is destructive.

1. Simple Constructive Dilemma

If A is B, A is C; if A is D, A is C.

Either A is B or A is D.

∴ A is C.

If he works hard, he will pass and if he gets tuition he will pass.

Either he works hard or goes for tuition.

∴ He will pass.

This is a simple dilemma because the conclusion is a categorical proposition. It is constructive because the minor premise affirms the antecedents of the major premise.

2. Complex Constructive Dilemma

If A is B, A is C; if A is D, A is E.

Either A is B or A is D.

∴ Either A is C or A is E.

If Ram plays chess, he will be late for cinema and if he plays badminton, he will

reach cinema early.

Either he plays chess or badminton.

∴ Either he is late for the cinema or reaches early for the cinema.

This is complex, since the conclusion is a disjunctive proposition. It is also constructive because the minor premise affirms the antecedents of the major premise.

Let us check



Change into complex Constructive dilemma.

If you act justly, men will hate you and if you act unjustly, God will hate you.

.....

.....

3. Simple Destructive Dilemma

If A is B, A is C; if A is B, A is D.

Either A is not C or A is not D.

∴ A is not B.

If I am to continue in politics, I must be able to support my convictions and if I am to continue in politics, I have to support my party.

I must either not support my convictions or not support my party.

∴

The dilemma is simple (conclusion categorical). It is destructive because the minor premise denies the consequents of the major premise.

4. Complex Destructive Dilemma

If A is B, A is C; if A is D, A is E.

Either A is not C or A is not E.

∴ Either A is not B or A is not D.

If your education is broad, you have read everything and if you are virtuous, you have not read immoral literature.

Either you have not read everything or you have read immoral literature.

∴ Either your education is not broad or you are not virtuous.

The dilemma is complex (conclusion disjunctive) and destructive because the major premise denies the consequents of the major premise.

Let us check



Change into complex destructive dilemma.

If the competitive examinations are strict, good candidates will be discouraged and if they are easy, bad candidates are likely to be selected.

.....
.....

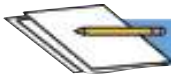

Summary

Through the detailed study of syllogism, a student can develop a critical mind. He/She will distinguish between right and wrong, valid and invalid arguments in conversations. All valid conclusions are strictly implied in the premises. But it requires intelligent procedure to make explicit what is implicit. Syllogism represents the form in which everyone engages in arguments. Theoretically it is important because it is present in deductive demonstrations. In mathematics syllogism is rich enough to give an exercise of thought. Whenever we are in a dilemmatic situation, our mind tries to find out a solution. Syllogism has an important place in the practical use of logic because much of our thinking consists of syllogism.



I can

- identify the definition of syllogism.
- identify the meaning of figure, mood and form of a syllogism.
- write the rules for making valid categorical syllogism.
- distinguish between truth and fallacy of an argument.
- make a valid categorical syllogism.
- distinguish between hypothetical and disjunctive syllogisms and dilemma.
- make new examples of hypothetical and disjunctive syllogisms and dilemma.
- choose appropriate alternative when in a dilemmatic situation.



Let us assess

Exercise 1

1. A syllogism is
 - a. immediate inference
 - b. mediate inference
 - c. eduction
 - d. none of these
2. A categorical syllogism is
 - a. mixed syllogism
 - b. dilemma
 - c. pure syllogism
 - d. none of these
3. A hypothetical syllogism is
 - a. mixed syllogism
 - b. categorical syllogism
 - c. dilemma
 - d. none of these
4. A dilemma in which the conclusion is a disjunctive proposition and in which minor premise denies the consequent of the major premise is.
 - a. Simple constructive
 - b. Simple destructive
 - c. Complex constructive
 - d. Complex destructive
5. The term of the syllogism which does not occur in the conclusion but appears in both the premises is called
 - a. Major term
 - b. Minor term
 - c. Middle term
 - d. None of these
6. The _____ of a syllogism is that which indicates the position of the middle term in the premise.
 - a. Mood
 - b. Rules
 - c. Figure
 - d. None of these
7. The fallacy of equivocation may be called _____.
 - a) Illicit process
 - b) Ambiguity
 - c) Quarternio - terminorum
 - d) None of these
8. If it rains, the ground will be wet
The ground is not wet.
It did not rain. This is an example of
 - a) Modus ponens
 - b) Modes tollens
 - c) Moduns ponendo tollens
 - d) None of these

Exercise 2

1. Read the following syllogism.
All scientists are graduates.
Some social workers are scientists.
Some social workers are graduates.
Is it a valid syllogism? Write the rules of a valid syllogism.

Logic and Reasoning

2. Read the following symbolic illustration of a dilemma.
If A is B, C is D and if E is F, C is D.
Either A is B or E is F.
C is D.
 - a. Name the dilemma.
 - b. Symbolically illustrate the other three forms of dilemma.
3. The figure of a syllogism indicates the position of the middle term in the premises. Illustrate the arrangements of middle term in different syllogism and draw all the possible figures.
4. If A is B, C is D.
A is B.
C is D.
Above syllogism is an example of Modus Ponens. Which are the other kinds of Hypothetical syllogism. Write two fallacies of Hypothetical syllogism.
5. A syllogism has a disjunctive major premise, a categorical minor premise and a categorical conclusion.
 - a. Identify the kind of mixed syllogism.
 - b. Construct two other forms of the same mixed syllogism.
 - c. Discuss the fallacies of this mixed syllogism.

Exercise 3

There are two statements followed by two conclusions (i) and (ii). You have to take the given two statements to be true even if they seem to be different from commonly known facts. Read the conclusion and then decide which of the given conclusions logically follows from the two given statements.

Tick [✓]

- (A) If only conclusion (i) follows.
- (B) If only conclusion (ii) follows.
- (C) If either (i) or (ii) follows.
- (D) If neither (i) nor (ii) follows.

1. **Statements :** No women teacher can play football. Some women teachers are athletes.

Conclusions:

- (i). Male athletes can play football.
- (ii). Some athletes can play football.
- A. Only conclusion (i) follows.
- B. Only conclusion (ii) follows.
- C. Either (i) or (ii) follows.
- D. Neither (i) nor (ii) follows.

2. **Statements :** All mangoes are golden in colour. No golden-coloured things are cheap.

Conclusions:

- (i). All mangoes are cheap.
 - (ii). Golden-coloured mangoes are not cheap.
 - A. Only conclusion (i) follows.
 - B. Only conclusion (ii) follows.
 - C. Either (i) or (ii) follows.
 - D. Neither (i) nor (ii) follows.
3. **Statements :** Some kings are queens. All queens are beautiful.

Conclusions:

- (i). All kings are beautiful.
 - (ii). All queens are kings.
 - A. Only conclusion (i) follows.
 - B. Only conclusion (ii) follows.
 - C. Either (i) or (ii) follows.
 - D. Neither (i) nor (ii) follows.
4. **Statements :** Some doctors are fools. Some fools are rich.

Conclusions:

- (i). Some doctors are rich
 - (ii). Some rich are doctors.
 - A. Only conclusion (i) follows.
 - B. Only conclusion (ii) follows.
 - C. Either (i) or (ii) follows.
 - D. Neither (i) nor (ii) follows.
5. **Statements :** All roads are waters. Some waters are boats.

Conclusions:

- (i). Some boats are roads.
 - (ii). All waters are boats.
 - A. Only conclusion (i) follows.
 - B. Only conclusion (ii) follows.
 - C. Either (i) or (ii) follows.
 - D. Neither (i) nor (ii) follows.
6. **Statements :** All flowers are trees. No fruit is tree.

Logic and Reasoning

Conclusions:

- (i). No fruit is flower.
- (ii). Some trees are flowers.
- A. Only conclusion (i) follows.
- B. Only conclusion (ii) follows.
- C. Either (i) or (ii) follows.
- D. Neither (i) nor (ii) follows.

7. **Statements :** Every minister is a student. Every student is inexperienced.

Conclusions:

- (i). Every minister is inexperienced.
- (ii). Some inexperienced are students.
- A. Only conclusion (i) follows.
- B. Only conclusion (ii) follows.
- C. Either (i) or (ii) follows.
- D. Neither (i) nor (ii) follows.

8. **Statements :** All fish are tortoise. No tortoise is a crocodile.

Conclusions:

- (i). No crocodile is a fish.
- (ii). No fish is a crocodile.
- A. Only conclusion (i) follows.
- B. Only conclusion (ii) follows.
- C. Either (i) or (ii) follows.
- D. Neither (i) nor (ii) follows.

9. **Statements :** Some dedicated souls are angles. All social workers are angels.

Conclusions:

- (i). Some dedicated souls are social workers.
- (ii). Some social workers are dedicated souls.
- A. Only conclusion (i) follows.
- B. Only conclusion (ii) follows.
- C. Either (i) or (ii) follows.
- D. Neither (i) nor (ii) follows.

10. **Statements :** Some students are naughty. All students are Indians.

Conclusions:

- (i). Some Indians are naughty.
- (ii). All naughty beings are Indians.
- A. Only conclusion (i) follows.
- B. Only conclusion (ii) follows.
- C. Either (i) or (ii) follows.
- D. Neither (i) nor (ii) follows.

5

OBSERVATION AND EXPERIMENT**KEY CONCEPTS**

- Observation
- Requirements of sound observation
- Characteristics of scientific observation
- Types of observations
- Experiment
- Advantages of observation over experiment
- Advantages of experiment over observation
- Fallacies of observation.



In this chapter we discuss that observation and experiments are the basic methods used in collecting data which are necessary for induction. So both observation and experiments are considered as the two material grounds of Induction. Observation is the beginning. It supports the middle and it determines the end of inductive enquiry.

The validity of induction directly depends upon the accuracy of observation and experiment. In the absence of careful observation and well planned experiments, the facts will remain doubtful. The induction will be no more than a guess.

Logic and Reasoning

Have you noticed a rainbow?

Instance 1 - Look at the picture.



It is one of nature's splendid shows! A rainbow is an excellent demonstration of the dispersion of light. It appears when raindrops or mist reflect sun light, and breaking white sunlight in to colors.

Instance 2 - Let us bring the rainbow in to our class room!!!

We usually have to wait until storm has cleared and the sun comes out to see a rainbow. But we can create the rainbow inside our own classroom.

For this we need:

1. a shallow pan
2. water
3. flash light/sunlight
4. a white surface/piece of paper
5. a mirror.

What to do?

Step 1

- Fill half of the pan with water.

Step 2

- Place the mirror in the water at an angle.

Step 3

- Turn on light and pass it through water on to the mirror.
(Sunlight can also be used.)

Step 4

- Hold a white paper above the mirror; adjust the angle until you see the rainbow appear.

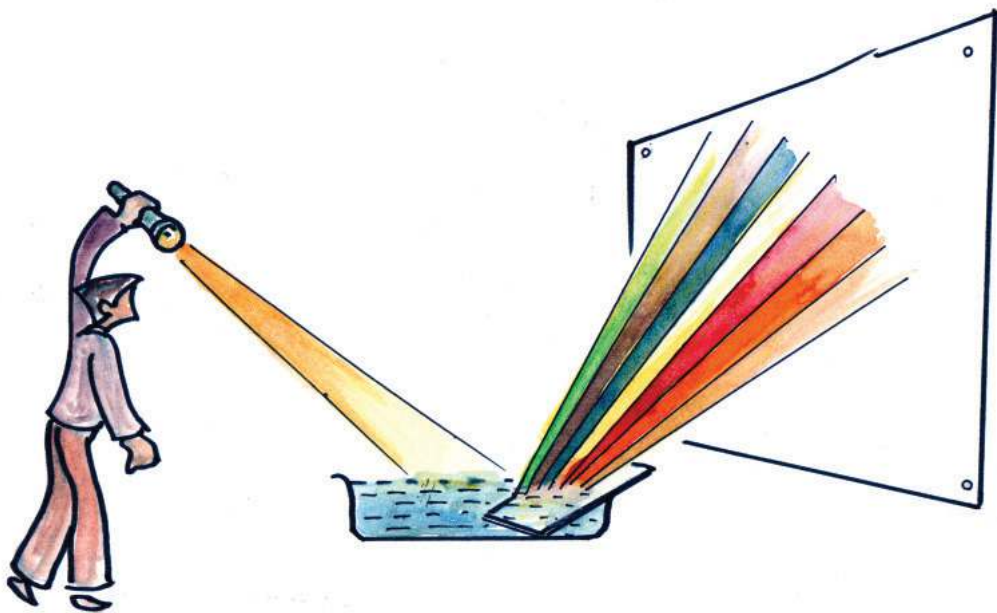

Activity 1

Compare the rainbow in the above two instances.



Do you know how Newton conducted this experiment to prove the dispersions of light in his laboratory?

Newton's experiment

Isaac Newton was a young scientist studying at Cambridge University in England during 1666-68. He was very interested in learning all about light and colors. One bright sunny day, Newton closed all the windows and darkened his lab. He made a hole in his window shutter, allowing just one beam of sunlight to enter the room. He then took a glass prism and placed it in the sunbeam. The result was spectacular – there was a multi colored band of light just like a rainbow. This band of light is called colour spectrum.

Newton believed that all the colors he saw were in the sunlight which entered into his room. He thought he should be able to combine the colors of the spectrum and make the light white again. To test this he placed another prism upside-down in front of the first prism.

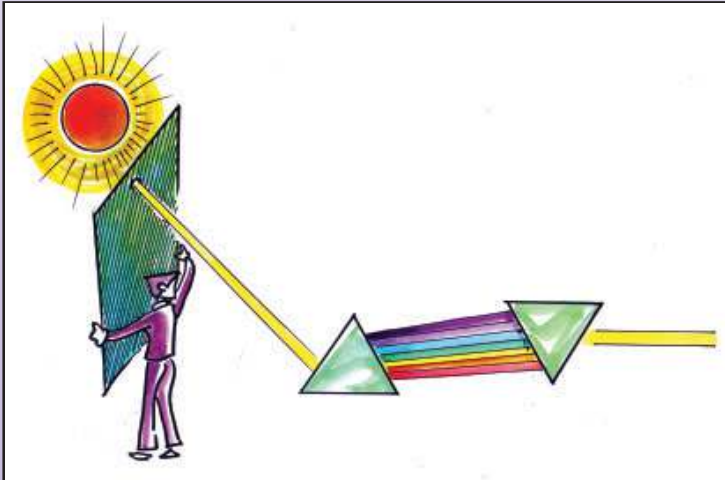

He was right. The band of colors combined again to produce white sunlight. Newton was the first to prove that white light is made up of all the colors that we can see.

Observation- Meaning and definition

The process in the first instance of rainbow is observation. Observation supplies the data for inductive generalization. Observation may be defined as the regulated perception of an object for a definite purpose. The word observation comes from the Latin word '*observare*'. It means 'to watch, to note, to pay attention to etc.' (*ob* = 'before' + *servare*

= 'to keep'). Observation means keeping an object before the mind. Hence observation is 'the act of becoming aware of an object through the sense organs and interpreting them by means of concepts.'

Observation is something more than perception

Observation is not a mere sense activity or a passive reception of facts through the senses. It is not a loose and aimless gazing at things in nature. According to Oxford Concise Dictionary, observation is 'accurate watching, noting the phenomenon by which they occur in the nature with regard to the cause and effect of mutual relations.'

Observation is the purposeful or attentive perception of a phenomenon presented by nature. It requires the application of our physical as well as intellectual faculties. The mind has to react to our sensation and interpret them. The true observer is the mind. But no observation is possible without the aid of the senses.

Observation is different from ordinary perception. Unlike perception observation is an active perception. It involves judicious and active concentration and attention. Observation is selective perception of facts with a certain purpose. All observations are perceptions but all perceptions need not be observations.

Let us check



Observation

- active perception
-
-
-

Mere Perception

- passive sense activity
-
-
-

Characteristics of Scientific Observation

Here are the main characteristics of observation.

- ❖ Purposeful
- ❖ Selective
- ❖ Objective

Observation is:

- 1) **purposeful and teleological:** Observation is a purposeful perception of facts with a definite aim. It is the study of events as they occur in nature. A tourist's perception of a lion is different from that of a zoologist watching a lion in a den after prey is introduced to determine the swiftness of the animal's response. Observation on the other hand is perception plus purpose.
- 2) **selective:** Observation is perception with definite purpose. So an observer must select only those facts which are connected with the purpose. While we observe we are not to pay attention to everything in the field of perception. Out of millions of facts in nature the mind chooses only the relevant facts for the purpose. Our purpose and interest determine what we observe. Take a farmer, an artist and a botanist on a hill side and ask them what they see. The farmer is likely to notice the nature of the pasture, the artist the beauty of the landscape the botanist the variety of plants. Selection implies rejection. To select is to reject all others. The selection helps the scientist to separate between relevant and irrelevant facts.
- 3) **objective:** During observation the personal biases and opinions may affect the objectivity of observation. Objectivity means to keep one's own opinions, emotions, prejudices and biases out of a situation. When the observer knows what the study is about there are chances to develop an opinion about what the result should be. The tendency 'I see what I wanted to see', is very common. Therefore, a scientific observer should have objectivity.
- 4) **instrumentation:** Observation depends upon our sense organs. The capacities of our sense organs are limited, e.g. our eyes can see only up to a certain distance. The field of our visual perception is limited. If we want to see things beyond this field we must make use of certain instruments. Scientific instruments extend the field of observation. They make observation accurate. Observation employs various methods and devices for more accuracy, clarity and effectiveness.



Some instruments used in observation.



Microscope

Used to see objects that are too small for the naked eye.

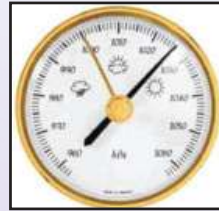

Barometer

Used to detect changes in the Earth's atmospheric pressure.



Thermometer

Measures temperature or temperature gradient using a variety of different principles.



Camera

Used to capture images.



MRI machine

A medical imaging technique used in radiology to investigate the anatomy and function of the body in both health and disease.



Pathometer

A lie detector that measures electrical impulses of the body.

Requirements of a Sound Observation

Observation aims at discovering the basic assumptions, rules and principles which are important for the process of Induction. There are some essential requirements for sound observation. They are:

- The observer must be qualified for the task. He/She must possess the necessary knowledge of the subject matter.
- The observer must possess intellectual curiosity or a spirit of enquiry. Newton asked “why does the fruit fall to the ground and not go up?”
- The efficiency to use and manipulate various instruments used in observation.
- Possession of normal senses is a pre-condition for an observation. A blind person cannot make any observation about colours and a deaf person cannot make any observation about sound.
- Good imagination and capacity to build good hypothesis on observed facts.
- Impartiality is one of the most essential characteristics of a good observer. Bias and prejudices would make observation one-sided. All the instances come across must be carefully observed.
- Openness of mind and flexibility to accept facts and to reject falsehood and mistaken views.
- A good observer must be a man of great patience, untiring in noting the various details of the phenomenon.

Let us check



Complete the following.

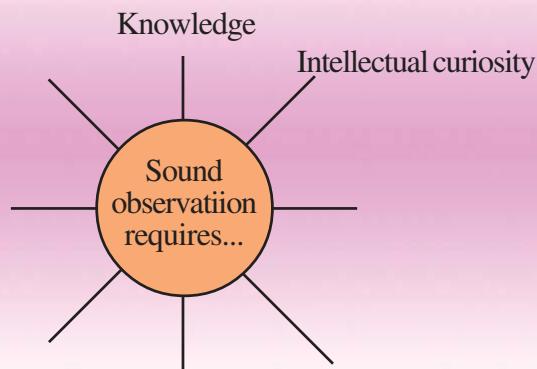



Some Examples of observation

1. A Principal observing a trainee teacher's classes in order to evaluate the person's effectiveness as an educator.
2. A scientist looking at a chemical reaction during an experiment.
3. A doctor watching a patient after administering an injection.
4. A parent watching her children interact with other children on the play ground.
5. An astronomer looking at the night sky and recording data regarding movement and brightness of the objects.
6. Fighter controllers watching their monitors for air plane movements and locations.
7. A child watching a fish in a tank.
8. A botanist recording daily data on plant growth.
9. A coach watching a group of athletes for team selection.
10. A psychologist watching a wife's reaction to her husband's confession.
11. A day-care teacher watching children's interaction.
12. A baker watching cake in the oven during the baking.
13. A coach watching children play to assess their strength and weakness.
14. A director watching the actors' performance in a scene.
15. A member of the audience watching a movie projected on the big screen.

What are the types of Observation?

There are certain types of observation. They are:

1. **Subjective and Objective observation:** All observations consist of the two main components-the subject and the object. Subjective observation involves the observation of one's own immediate experience. The observations involving observer as an entity apart from the thing being observed, are referred to objective observation. Objective observation is also called retrospection.

2. **Casual and Scientific observation:** An observation can be casual or scientific. Casual observation involves observing the right thing at the right place and also at the right time by a matter of chance or by luck. But a scientific observation involves the use of the tools of measurement. All observations are not scientific in nature.
3. **Natural observation:** Natural observation involves observing the behavior in a normal setting. In this type of observation, no efforts are made to bring any type of change in the behavior of the observed. Improvement in the collection of the information and improvement in the environment of making an observation can be done with the help of natural observations.
4. **Direct and Indirect observation:** In direct observation the observer is physically present in the process. Hence the observer knows the type of situation that is presented to him. This type of observation monitors what takes place. Indirect observation involves studies of mechanical recording or other means of recording like photography. Compared to indirect observation, direct observation produces immediate awareness of the given facts or situation.
5. **Participant and Non-Participant observation:** Participation of observers with various types of operations of the group under study is called participant observation. But in the non-participant observation, there is no participation of the observer in the activities of the group. There is also no relationship between the researcher and the group.
6. **Structured and Unstructured observation:** Structured observation works according to a plan. The operations that are to be observed and the various features that are to be recorded are decided well in advance. But in the case of the unstructured observation, observer has the freedom to note down what he or she feels about the observation. It is performed without any plan.
7. **Controlled and Uncontrolled observation:** Controlled observations are the observations made under the influence of some of the external forces. Uncontrolled observations are made in natural environment. These observations involve no influence or guidance of any type of external force.



Activity 2

A

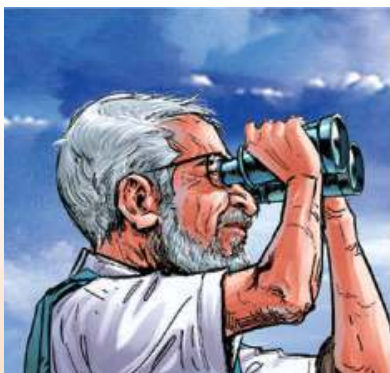

B

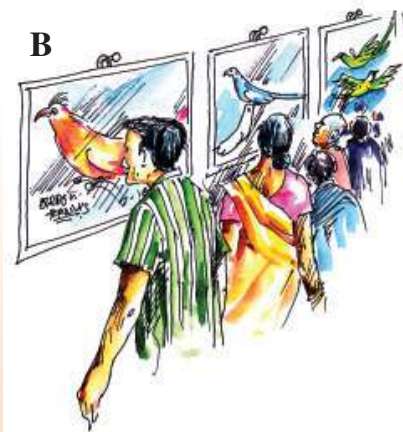

Which is direct observation, A or B?

List the merits of direct observation.

-
-
-
-
-

1. Advantages of observation

1. Observation has wider scope.

The natural phenomenon is truly revealed through observation. The knowledge about distant objects like stars comets or the effect of some unusual circumstances like earthquakes, wars etc. is known through observation only. In this sense observation has wider scope of application and it is universally applicable.

2. One can pass from cause to effects and effects to cause in observation.

Given the effect we can observe and discover its cause as in the case of post-mortem. Given the cause we can observe the effect, e.g. if a particular drug is injected in to the human system, then we can observe its effect.

3. Observation is the pre-condition to experiment.

It means that observation is a preparatory way for experiment. Whatever may be the experiment it is to be observed first. Newton observed the falling of the apple first and then proved the gravitational force through experiment. It shows that observation precedes experiment.

Logic and Reasoning

4. Through observational method, the investigator gets a real picture of the events as they manifest in the natural setting. So there is greater possibility to get unbiased and systematic data from the observation.
5. Certain phenomena can be assessed and properly understood only through observation. E.g. Crowd behavior, social behavior of animals, the interaction between mother and child etc.

Experiment

Creating the rainbow in the class room was an experiment. Experiment is the central feature of science. The word experiment is derived from the Latin word '*experimentum*' meaning, a trial, a test or a proof. It is the process of collecting facts which are artificially produced by man himself. Experiment is observation under artificial and controlled condition. When the eclipse occurs we merely observe but when we add alkali with acid to produce salt, we do experiment. In the words of Bain "observation is finding a fact, and experiment is making one."

Observation is a regulated perception of natural events under natural condition. Experiment is the artificial re-production of events under pre-arranged conditions. Unlike observation, the experimenter has full control over the phenomena and can be repeated at his will.

The distinction between observation and experiment does not consist in the use of instruments. So long as we do not interfere with the phenomenon as it occurs in nature, it is observation. E.g. an astronomer uses telescope to observe the heavenly bodies but he is not performing an experiment, because he has no control over the phenomenon. But if instruments are used to alter the conditions of events as in the case of light passing through the spectroscope, then we do experiments. The distinction between observation and experiment is not absolute or fundamental. They differ only in degree and not in form. Experiment is just a special form of observation.

Experiment involves observation. Even while performing experiment the experimenter must observe the events. Experiment is performed for the purpose of better observation.



Galileo's experiment on falling objects

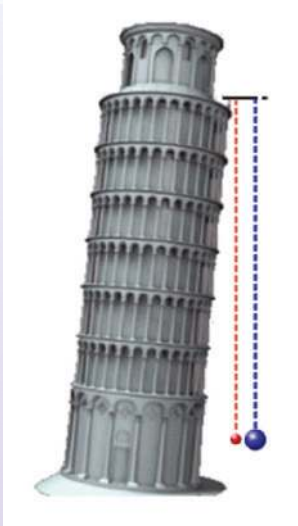

In the late 1500's, everyone knew that heavy objects fall faster than lighter ones. After all, Aristotle had already said so. That an ancient Greek scholar still held such influence was a sign of how far science had declined during the dark ages.

Galileo Galilei, who held a chair in mathematics in the University of Pisa, questioned the common knowledge. The story has become part of the folklore of science. He dropped two different weights from the town's Leaning Tower showing that they landed at the same time. His challenges to Aristotle may have cost Galileo his job. But he had showed the importance of taking nature, not

human authority, as the final arbitrator in matters of science.

Rutherford's discovery of the nucleus

Ernest Rutherford was experimenting with radioactivity at the University of Manchester in 1911. Then atoms were generally believed to consist of large mushy blobs of positive electrical charge with electrons embedded inside — the “plum pudding” model. But when he and his assistants fired tiny positively charged

alpha particles, at a thin foil of gold, they were surprised. A tiny percentage of them came bouncing back like bullets. Rutherford calculated that most of the mass must be concentrated in a tiny core, now called the nucleus, with the electrons moving around it. With amendments from quantum theory, this image of the atom remains today.

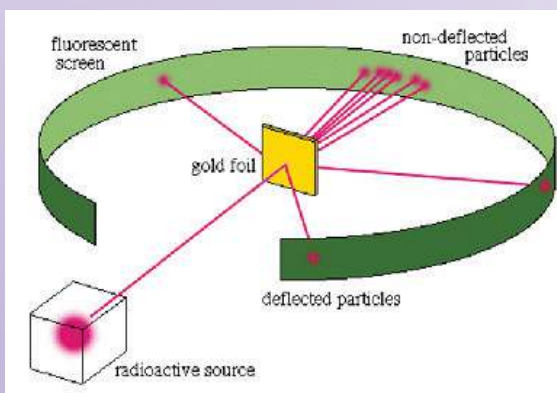



Large Hadron Collider (LHC)

The Large Hadron Collider (LHC) is the highest-energy particle collider ever made. It is considered as 'one of the great engineering milestones of mankind.' It was built by the European Organisation for Nuclear Research from 1998 to



2008. Its aim was to allow physicists to test the predictions of different theories of particle physics and high-energy physics, and particularly prove or disprove the existence of the theorized Higgs particle and of the large family of new particles predicted by super symmetric theories.

The LHC was built in collaboration with over 10,000 scientists and engineers from over 100 countries, as well as hundreds of universities and laboratories. It lies in a tunnel 27 kilometers in circumference, as deep as 175 meters (574 ft) beneath the Franco-Swiss border near Geneva, Switzerland.

Merits of Experiments

The experiment has a lot of advantages over observation. Let us discuss them.

1. Variation of facts

Quantitative change can be brought in the case of experiment. This can be explained by the help of an example. A doctor experiments with a patient using certain medicine with certain doses. He may experiment with it by increasing or decreasing the quantity of the ingredients because quantitative change is possible in case of experiments.

2. Time saving

The experiments are performed under the control of the performer. Hence the problem of waiting for the occurrence of the event in nature does not arise in the case of experiment. If someone wants to study the monsoon, he has to wait until its arrival. But in the case of experiment this waiting is not required.

3. Chance for repetitions and modifications

The chance for modification and repetition are possible in case of experiment as per the requirement. The performer of the experiment is the master of the situation. To study the effect of heat in the metal several experiments can be conducted till we are satisfied with the condition. The experiment is always within the performers' control. He can repeat or modify it as per his need.

4. Rapid and sure progress

Experimental sciences like, Physics, Biology etc. have made tremendous progress in extending our knowledge in the area concerned. So we have rapid changes in the modern world. The problem under investigation gets quick solution through experiment.



Activity 3

Do you think observation has any advantages over experiment?

- Conduct a debate and complete the following table.

Experiment	Observation
➤ Control over the phenomenon	➤ Phenomenon is beyond our control
➤	➤
➤	➤
➤	➤
➤	➤

Fallacies of observation

We can't rule out the possibilities of errors in the process of observation. Errors in observation may lead to fallacious induction. The fallacy in observation affects the purpose of inductive procedure. So it is necessary to know the fallacy of observation not to commit them.

There are certain difficulties in the ways of sound observation.

- Complexity of the phenomenon under investigation.
- Time limit of the phenomenon.
- Limited capacities and weakness of the observer.
- Likes, dislikes, pet theories, pride and prejudices of the observer.



Mill classifies fallacies of observation into Positive (Mal-observation) and Negative (Non-observation).

Fallacy of Mal-observation

Closely observe the following pictures.



There are cases of observation where the actual objects are observed as something else. Mal observation is a positive mistake because it is the fallacy of wrong understanding. Sometimes a mirage is perceived as water or a straight rod is perceived as bent when half immersed in water. Similarly, the parallel railway lines appear to be meeting at a point. Such types of positively wrong observation are known as mal-observation. Mal-observations are categorized in to two types.

1. Individual mal-observation.
2. Universal mal-observation.

Individual mal-observation

When any individual wrongly observes a thing to be another it is individual mal-observation. E.g. the observation of a rope as snake. It is a case where an individual is confused with unconscious inference that leads to the fallacy. Unconsciously one reaches at the conclusion that what he observes is a snake, whereas it is actually a rope. If he had been careful enough, he would not have observed it so. It consists in wrongly interpreting sense impression.

Universal mal-observation

Look at the picture.



Is the colour of the sky and sea really blue?

There are certain cases of illusions and hallucinations which are universally found with everyone. Everyone may commit that mistake under similar circumstances. The parallel railway lines appear to merge at certain point. Here careful observation will not help in overcoming such wrong perception. Because it is possible for everyone to commit this fallacy. It is called universal mal-observation. In case of universal mal-observation undue assumptions are wrongly inferred. The most popular example of universal mal-observation is the case of sunrise and sunset. We think that we observe sunrise and sunset, whereas scientifically there is neither sunrise nor sunset.



Activity 4

List some examples of universal mal-observation.

-
-
-
-
-

Fallacy of Non-observation

The fallacy of non-observation occurs when what should have been observed is overlooked or omitted. Non-observation is a negative mistake because it is a fallacy of neglecting the relevant instance. The fallacy of non-observation occurs in two ways. They are: non-observation of essential circumstances (partial non- observation), non-observation of instances (complete non observation).

1. Non-observation of essential circumstances

Observe the picture.



Is it the real shape of the moon?

Since we observe only the partial moon, can we say it as the real shape of the moon?

While making the observation, if you overlook the instances which are important for the purpose of investigation, then it leads to the fallacy of non-observation of essential instances. For example, a person actually suffers from malaria. If the doctor overlooks the symptoms of malaria and takes it as some other fever, it will become a case of non-observation of essential instances. This fallacy can be avoided if extreme care is taken at the time of investigation

2. Non-observation of instances

Non observation of instances is a fallacy in which we overlook instances, which are relevant for investigation. It is a case where some instances are overlooked either unknowingly or because of certain prejudices. The argument 'No Indians are punctual'

is an example of non observation of instances. Here from the observation of a few instances of persons who are not punctual, Indians are blamed. This argument does not observe instances that are contrary to the conclusion.

Many superstitions are due to the non-observation of instance.

- Tuesday is an inauspicious day.
- Good people die young.
- Only wicked prosper in this world.
- Fortune favours the brave.

Let us check



Find out the differences between mal-observation and non observation.

-
-
-
-
-

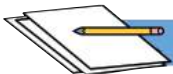

Summary

Observations and experiments are the techniques used in inductive enquiry. They are the real basis of all scientific investigation. Observation is the deliberate and attentive perception in natural condition. Observation, in order to be sound, demands certain requirement. There are different types of observation. Experiment is the central feature of science. It is observation under artificial and controlled condition. The error in the process of observation is called the fallacy of observation. Mal-observation and non-observation are the fallacies.



I can

- differentiate between observation and experiment.
- recognise that observation and experiment are integral part of scientific investigation.
- do certain simple experiments.
- realise the fallacies in observation.

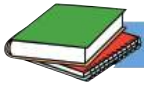

Let us asses

1. The original meaning of observation is
 - a. to look carefully
 - b. to see
 - c. to watch
 - d. have a sight
2. How does observation differ from mere perception?
3. Give your own definition for observation.
4. Examine the statement 'observation is purposeful and teleological'.
5. List the limitations of observation.
6. Examine the requirements of sound observation.
7. A teacher is observing students during free time. What are the required qualities of such a teacher to get good result in observation?
8. How can you differentiate subjective observation from objective observation?
9. List the advantages of participatory observation?
10. Prepare a chart showing the advantages and disadvantages of participatory observation.
11. Prepare PPT slides to teach different types of observation.
12. 'Experiment is observation under artificial and controlled condition'. Clarify.
13. Prepare a chart showing the differences between observation and experiment.
14. Give examples for non-observation of instances.
15. Prepare a flowchart of fallacies of observation.
16. Differentiate between individual mal-observation from universal mal-observation.

6

SCIENTIFIC METHOD**KEY CONCEPTS**

- Sources of Knowledge
- Method of Tenacity
- Method of Authority
- Method of Intuition
- Scientific Knowledge
- Characteristic features of Science
- Scientific Method
- Inference - Deduction and Induction
- Kinds of Induction
- Problem of Induction
- Postulates of Induction
- Inductive - Deductive Approach
- Steps of scientific Method.



This chapter discusses different sources of knowledge. The scientific method has advantages over other methods. The scientific method consists of inductive and deductive inference. The postulates of induction is the solution to the problem of induction. The scientific method has various steps.

Sources of Knowledge

Look at the following statements...

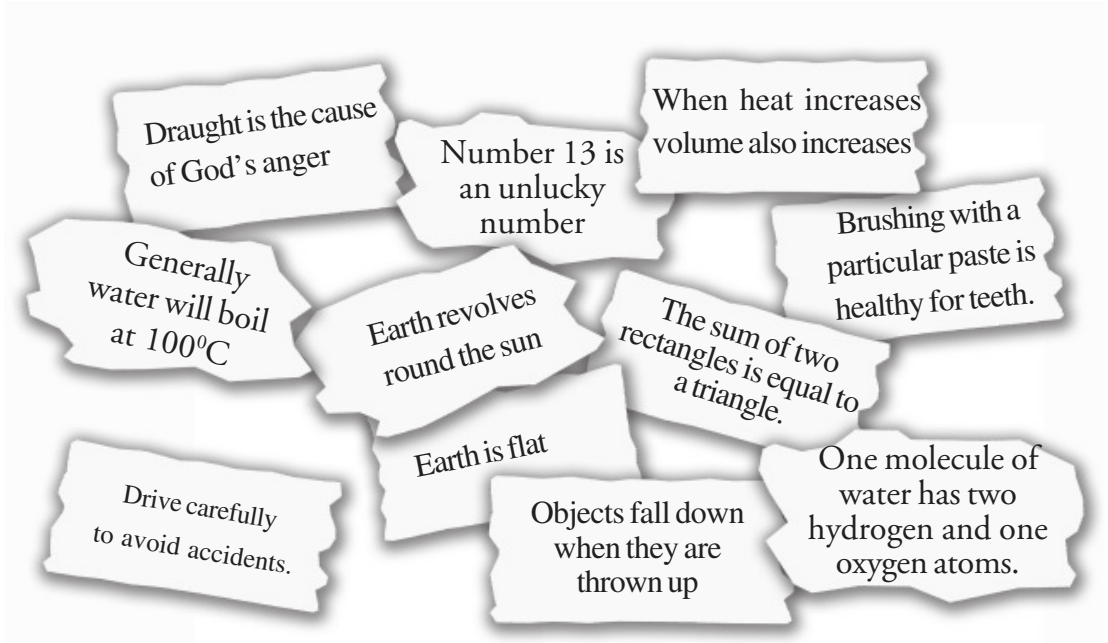

Activity 1

Arrange the above statements in the suitable boxes. Add one or two statements from your life in each box.

1	Traditional/Habitual belief
2	Suggestion/advice from a trustworthy person
3	Knowledge from immediate understanding
4	Knowledge from science

The process of forming habitual belief is called the Method of tenacity. The process of acquiring knowledge from trustworthy persons is known as the Method of authority. The process of deriving knowledge from immediate understanding is known as the Method of intuition. The process of deriving knowledge through experiments is called the Method of Science. Let us examine them in detail.

The Method of Tenacity

Look at the picture.



Activity 2

Discuss in group the factors that lead to such beliefs.

Put a ✓ if the statements in activity 1 are factually correct and ✗ if they are incorrect.

The method of tenacity is a common attitude which strengthens one's beliefs. Such beliefs get accumulated and are subsequently misunderstood as giving rise to true knowledge. Man's earliest search for truth was greatly influenced by custom, tradition etc. Habits make us always believe that a proposition is true. If anyone questions our virtues or religious beliefs we are not ready to accept them. Though the method is unscientific, people are doing it in their daily life.

The method has the following limitations.

Logic and Reasoning

1. The method of tenacity cannot always secure stability of one's belief.
2. Lack of uniformity in belief.
3. It is subject to serious doubts.

Think and add a few more limitations.

4.
5.

The Method of Authority



Activity 3

Discuss in group and list similar piece of knowledge from any authorities that you have come across in your daily life.

-
-

Authority is another source of knowledge. There are so many authorities in the society, the government, judiciary, officers, teachers, parents etc. Students for example, will turn to their teacher when doubts arise and generally accept the answers as final. Similarly, political, economic and social questions are frequently settled by the directions from authorities concerned. For instance, one can think of a judicial case in which the court will normally judge in favour of one. The judgment will remain true until the other person appeals to a higher court. If the higher court discards the judgment, it will become void.

Examples

1. Doctor's advice in the case of a particular disease
2. RBI Governor's measures in the event of the depreciation of Indian Rupee.

Let us check



Identify the limitations of the method of Authority.

1. The stability of belief cannot be achieved as long as authorities differ.
2.
3.
4.
5.

The Method of Intuition

When one gets a fact in just an actual instance and generalises from that instance, it is known as method of intuition. Many principles used in different sciences are derived in this way. The axioms are self-evident and do not need any proof.

The dictionary meaning of the word 'intuition' is 'sudden flash of knowledge'. This is another way of getting knowledge. The guiding principle is the 'self-evidence' of the proposition. It is taken for granted. Self-evidence is not a guarantee for the validity of the proposition. In ancient science there were a lot of propositions that were accepted as true, but were later proved to be wrong. e.g. 'The earth is flat,' 'the sun revolves round the earth,' etc. Therefore, intuitive knowledge must be tested before accepting it. The method does not involve any cause-effect relationship. So we cannot accept it as scientific.



Activity 4

Discuss in group and write down a few instances of intuitive knowledge as similar to that in box no. 3 (Page no. 122).

Limitations

1. Not scientific.
2. It is not final.
3. Not free from doubt.



Pseudo science

The word 'pseudo' comes from the Greek word meaning 'false'. The scientist named William Whewell is the first to coin the word 'pseudo science' in 1833. Pseudo-science refers to a claim, belief or practice which is presented as scientific but does not adhere to scientific method. These are non-provable claims which lack supporting evidence.

So there are limitations in the Method of Tenacity, the Method of Authority and the Method of Intuition.

Then what is the method which gives us correct knowledge?

The method which is beyond all these limitations giving definite, certain and universal knowledge is the real method. That method is known as the **Scientific Method** and the knowledge derived through this method is known as scientific knowledge.

Scientific knowledge

The word science originates from the Latin Word '*scientia*' meaning **knowledge**. It is the organized and tested knowledge which is obtained through **observation, identification, description, experimental investigation and theoretical explanation** of the phenomenon.

"The unity of all science consists in its method not in its material."



Karl Pearson
(1857-1936)





“To be learning something is the greatest of pleasure not only to the philosopher but also to the rest of mankind”

Aristotle (Poetics)



“What compels us to devise theory after theory? Why do we devise theories at all? The answer is simply because we enjoy “comprehending”, that is, reducing phenomena by the process of logic to something already known or (apparently) evident.” (*On the Generalized Theory of Gravitation*’ *Scientific American* 1950).

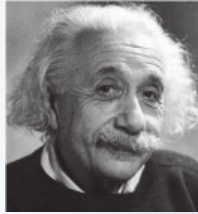

Albert Einstein
(1879-1955)

Characteristic features of science

The most important feature is that, it is based on observation and experimentation. The laws of science are objective. They are applicable everywhere, and their validity can be verified any time. Science is based on cause and effect relationship. It means the same cause will produce the same effect, e.g. Bacteria is the cause of diseases like abdominal disorder. It should be noted here that they are not final, they can later become wrong. This is called falsifiability. Falsifiability does not mean that a theory is false, but the theory is likely to be falsified.

The following are some of the features of science:

- A science is so-called not because of its subject matter but because it employs a scientific method.
- Science is the study of facts.
- Scientific principles are universal.
- Scientific laws' validity can be verified any time.
- Science searches for the cause-effect relationship in its subject matter.
- Science can make prediction on the basis of cause- effect relationship which is universal and inevitable. .
- Science relies on verifiable, measurable and valid evidences.

From the above characteristics of science we understand that scientific knowledge demands evidential support. Logic provides this evidential support by the process of inference.

Scientific Method

It is important that we use scientific method for the investigation of natural phenomena. It starts with the data obtained through observation and other means and then moves on to the formation of a theory. Logical reasoning is a tool for the formation of a correct theory.



Karl Pearson

“The scientific method is one and the same in all branches and that method is the method of logically trained minds”.

Inference

Complete the table with suitable conclusions.

Let us check



A	B
All electronic devices are blessings to human beings.	• The Mercury is a planet, it revolves round the sun
Computer is an electronic device.	• The Venus is a planet, it revolves round the sun.
∴	• The Earth is a planet, it revolves round the sun.
	• The Mars is a planet, it revolves round the sun.
	• The Jupiter is a planet, it revolves round the sun.
	• The Saturn is a planet, it revolves round the sun.
	• The Uranus is a planet, it revolves round the sun.
	• The Neptune is a planet, it revolves round the sun.

You have derived conclusions in the above table through your mental process. This mental process, in which from certain given statements we derive at a conclusion, is called inference. There are two types of inferences- **deduction** and **induction**. Scientific method consists of both these inferences.

Deduction

Column 'A' is an example of deductive inference. We have already studied deductive arguments in the form of syllogism in chapter 4. Deduction is a thinking process in which we proceed from **general to a particular** proposition. It is analytic in nature because here conclusion is reached by analyzing a general or universal proposition. In deduction we give more importance to its structure or its form. So deduction is commonly known as formal logic. There is a close relation between the premises and conclusion in a valid deductive inference. That is if the premises are true the conclusion must also be true. Deduction gives us sure conclusion.

Induction

Column 'B' is an example for inductive inference. An important mile stone in the development of logic was the inductive process of reasoning introduced by Francis Bacon.

Induction is a process of inference in which general conclusion is derived from particular facts, that is, it **begins with particular facts and proceeds to a general law**. It is synthetic in nature because it unites particular facts with a universal proposition. Induction is also known as material logic. Apart from its form it gives importance to content or matter. It always enquires whether the ideas agree to actual facts or not.



Sir Francis Bacon
(1561-1626)

Let us check



List the features of Deduction and Induction.

Deduction

- 1.
- 2.
- 3.
- 4.
- 5.

Induction

- 1.
- 2.
- 3.
- 4.
- 5.

In spite of the differences between induction and deduction, they are complementary to each other. Induction supplies the universal proposition that form the premises of deductive argument. It is induction that confirms the material truth of the universal law. Whereas, deduction examines the formal validity of induction.

Kinds of Induction

There are three types of induction. They are:

- a) Unscientific induction
- b) Scientific induction
- c) Analogy.

a) Unscientific induction

It is further divided into:

- i) Complete Enumeration
 - ii) Simple Enumeration.
- i) Complete Enumeration

In complete enumeration, a general principle about a class is formed on the basis of observing all members of the class. For example, by observing all books in the college library, a general statement can be made that 'All books in the college library bears the library seal'. However, this conclusion does not assert anything more than what is observed. The conclusion is nothing more than a deduction from the observed instances. Thus complete enumeration is a form of unscientific induction.

ii) Simple Enumeration

In simple enumeration, a limited number of instances of a class are observed for a specific property and the prediction is made for the whole class. E.g. We observe a few cheetahs and conclude that 'all cheetahs are spotted animals.' Since in simple enumeration the conclusion goes beyond the observed instances, it takes a leap in moving from the observed to the non-observed. There is inductive leap in simple enumeration.

b) Scientific Induction

In scientific induction too, as in the case of simple enumeration, we are moving from the analysis of a limited number of observed instances to a conclusion that refers to a whole class. The difference here is that the scientific induction presumes a cause-effect relation of 'cause and effect' between some elements of the observed instances and the observed phenomena. Then a relation between the causal element and the observed phenomena

is suggested as a general principle. For example, from the observation of various liquids being evaporated when heated, a general principle can be assumed that 'All liquids evaporate when sufficiently heated'. Here, from the observed instances of evaporation, a cause-effect relationship is assumed between the act of heating and that of evaporation. This relation is projected as a general principle. Scientific induction as explained here moves from the observed to the non-observed as in the case of simple enumeration. Or in other words, scientific induction is characterized by inductive leap. However, with a difference from simple enumeration, the inductive leap in this case assumes a cause-effect relation in support of this leap.

c) **Analogy**

Analogy is a form of inductive argument in which a conclusion is drawn from the similarity between two or more instances. Analogy is a case of probabilistic reasoning based on resemblance. It assumes that things similar in various aspects are likely to be similar in other aspects too. In analogy, the conclusion drawn is reached with probability, and this probability is governed by various factors.

For example, the likes and dislikes of Joe and Tom are similar towards various things. Joe enjoyed a newly released movie. From this we can assume that Tom will also enjoy the movie if he sees it. The similarities of likes and dislikes of Joe and Tom enable us to infer that Tom will like the movie as Joe likes it.

The instance, whose similarities are being compared, is known as the primary analogue. The instance to which these similarities are compared is known as the secondary analogue. The conclusion is a proposition drawn about some aspects of the secondary analogue. So in analogy we move from observed similarities to inferred similarity.

The Problem of Induction

“All technicians are skilled persons.”

Do you agree to this generalisation?

Have you seen all the technicians in this world before arriving at such a generalization?

This is the problem of induction-the jump from some to all, from known to unknown or from observable to unobservable. We observe certain particular facts and universalise it. This process is known as *inductive leap*. Before arriving at a universal proposition,

Logic and Reasoning

one cannot examine all the particular instances of the given phenomenon. It is something impossible.

In order to solve the problems due to inductive leap we have to depend upon certain universal and natural laws. These laws are called the **postulates of induction**.



The Scottish philosopher **David Hume** (1711–1776), thought that, there was no rational basis for our reliance on induction. Inductive reasoning, he argued, presupposes a belief in the ‘uniformity of nature.’ According to this it is assumed that the future will resemble the past when relevantly similar condition occurs. Some have tried to justify induction on the basis of its past success. In Hume’s own view, we cannot help but reason inductively. He insists that it is a matter of custom and habit and is not rationally justified. The so-called ‘**Problem of Induction**’ that Hume left behind, especially as its impact upon the foundations of science, remains an area of active debate to this day.



Postulates of Induction

The term ‘postulates’ refers to simple, self-evident and universal truths. The postulates are something above and beyond proof. They are also known as axioms. Though postulates are beyond proof, they work as the basis of all other proof. Every branch of science has its own axioms and without accepting them no knowledge is possible. Inductive logic is described as the logic of the scientific method. Inductive reasoning is based on the assumption that the world is an organic unity and not chaos.

The following are the Postulates of Induction.

- a. The Law of Universal Causation.
- b. The Law of Uniformity of Nature.
- c. The Law of Unity of Nature

The Law of Universal Causation

Is there anything that occurs without a cause?

The answer must be a no! *This law states that everything that exists and happens in this world must have a cause.* The law of universal causation is the basic law of science. Scientific experiments are done on the basis of this law. There is no causeless event in the world. For example acid is the cause of the colour change in litmus paper.

On the basis of the law of causation a causal connection is established between two events.

Let us reflect on the cause of rain.



Is cloud the cause of rain? Or is wind the cause of rain? Or is condensation the cause of rain? Or is evaporation the cause of rain?

Now let us see the definition of cause given by J.S.Mill.

“Cause is the totality of conditions of which the effect invariably and unconditionally follows.”

Find out the causes of the following effects.

Cause	Effect
.....	Nuclear bomb explosion
.....	Milk turns curd
.....	Night blindness
.....	Water boils

The Law of Uniformity of Nature



We can make ice cubes even in the scorching deserts of Africa, and get a bucket full of boiling water in chilling Antarctica. The above images represent three entirely different forms of water. But what are the circumstances needed for getting this result out of water?

The law of uniformity of nature holds that *the same cause will produce the same effect under similar circumstances*. In the circumstance the temperature is 0°C water turns ice and if the circumstance changes to a 100°C water becomes vapour, no matter where it is. Without the support of the law of uniformity of nature, inductive generalization will be very weak. It justifies the leap from some cases to all cases or from known cases to unknown cases like ‘Always water turns to ice in 0°C .’

The Law of Unity of Nature

Throughout human history, philosophers and seekers of knowledge have sought to discover a single fundamental principle underlying all the phenomena of the universe. *Though the universe is composed of different objects, a close study reveals the fact that there is an underlying unity in it.* Even things having different characteristics are inter-related in some way or other. Without accepting this postulate one cannot arrive at any generalization. Without generalization, induction is impossible.

Inductive-deductive Approach

The modern method of reasoning is generally attributed to Charles Darwin. He combined Aristotelian deduction with Baconian induction. This scientific method involves a back-and-forth movement. That is, here scientists first operate inductively and then deductively to check their validity.

Steps of Scientific Method



Read the story of Rahul

Rahul who is studying in 11th Standard is a smart and intelligent student. His teachers and his friends like him. He used to help his friends with their studies. He is the top scorer in class tests. But recently he has become a different boy, not concentrating on his studies, irregular in the class and looked so dull. Everyone who knew him could notice the changes in Rahul...

We could identify the problem of Rahul.



Activity 5

List out the probable causes of the changes in Rahul.

-
-
-
-
-

Only one among the probable causes must be the true cause of the problem of Rahul.

There is a process in fixing the real cause of the given problem which has certain steps. The scientific laws are also established through certain process that involves different steps. This process is called steps for scientific induction. They are:

- a. Observation of facts
- b. Formation of hypothesis.
- c. Verification of hypothesis
- d. Proving the hypothesis.

a. Observation of facts

The identification of the problem leads us to the observation of the facts. Observation is perception with a definite purpose. The purpose of observation in this context is to analyse facts concerning the given problem.

b. Formation of hypothesis.

In the case of Rahul you have guessed several probable causes for his behaviour. These types of guess works are known as hypothesis. It is an assumption about the cause of the phenomenon. It is just a tentative explanation.

c. Verification of Hypothesis

The hypothesis must be verified before taking it as the cause of the problem. Verification helps us find the correct hypothesis. A verified hypothesis is known as theory.

d. Proving the hypothesis

The final stage of scientific method is proving the hypothesis. By verification we only show that the hypothesis explains the facts, but not that it is the only explanation. To prove that the hypothesis is the sole explanation we should conclusively demonstrate that no other hypothesis can explain the fact. The proven hypothesis is called a law.

It may be noted that the characteristics of scientific method is not to prove the hypothesis in terms of absolute truth but to conclude that the evidence does or does not support the hypothesis.

You will have a detailed study of more steps of scientific method in chapter 10.

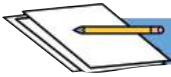

Summary

The sources of our knowledge are derived from scientific and unscientific methods. The unscientific methods are the methods of tenacity, authority and intuition. But correct knowledge is obtained only through scientific method. Inference plays a major role in the process of scientific method. Induction and deduction are the two types of inference. There are different kinds of induction. Inductive leap which is the problem of induction is solved by postulates of induction. There are several steps to make a scientific law through scientific method.



I can

1. distinguish scientific knowledge from other types of knowledge.
2. recognize the importance of logic in science through Deduction and Induction.
3. make use of the Modern Approach for verifying scientific laws in daily life.
4. analyse that the problem of Induction (Inductive leap) can be solved through the postulates of Induction



Let us assess

I. Choose the correct answer from a - d.

1. Identify the statement from method of tenacity.
 - a. Water is H_2O .
 - b. The sight of two mynas just before our journey is a good omen.
 - c. Using certain soap is good for health.
 - d. Whole is greater than the part.

Logic and Reasoning

2. The statement 'out of nothing, nothing comes' shows
 - a. The law of universal causation.
 - b. The law of uniformity of nature.
 - c. Law of unity of nature.
 - d. None of the above.

3. Inductive leap is _____
 - a. Jump from known to known.
 - b. Jump from known to unknown.
 - c. Jump from unknown to known.
 - d. None of the above.

4. Rahul tastes a mango and says, "All the mangos in this baskets are sweet." His statement is an example of _____.
 - a. Perfect induction.
 - b. Imperfect induction.
 - c. Deduction.
 - d. None of the above.

5. The word science originated from the word '*scientia*' which means (to analyse, to know, to observe, to experiment).

6. Scientific method is otherwise called
 - a. Deductive Method.
 - b. Inductive Method.
 - c. Inductive-Deductive Method.
 - d. None of the above.

Exercise 2

1. The Career Guidance Unit in your school conducted a programme on ‘Future Job Perspectives.’ The career guide suggested you to choose legal profession.
 - a. Identify the method of arriving at the knowledge behind this suggestion.
 - b. Evaluate that method and list out its limitations.
2. A class of students engages in a debate on the subject “scientific method has advantage over unscientific methods.”

Prepare a note on the advantages of scientific method.
3. Deduction and induction are complementary to each other. Discuss.
4. Your trip to Ooty was interrupted by food poison.

Think of .the problem and find out the cause using the steps of scientific induction.
5. Everybody says that Inductive-leap is a major problem of Induction. Demonstrate it with example and find out solution for the problem.

7

CAUSALITY

KEY CONCEPTS

- Meaning and definition
- Aristotelian view of cause
- J S Mill's definition of cause
- Analysis and elimination
- Mill's Experimental Methods
- The Method of Agreement
- The Method of Difference
- The Joint Method of Agreement and Difference

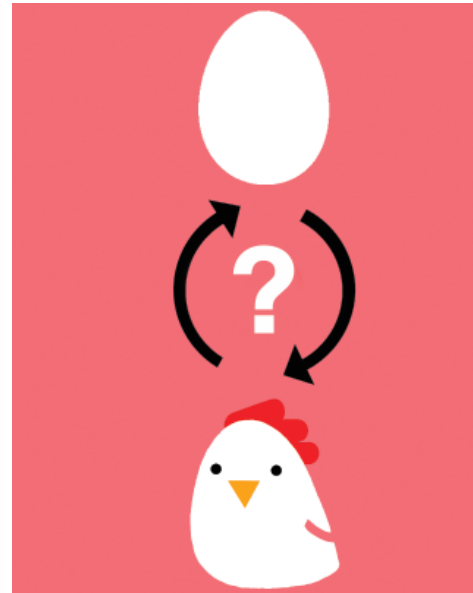

In this chapter we learn meaning and definitions of causality, different views of cause such as popular, Aristotelian and Modern. The cause – effect relation is discussed by giving emphasise to Mill’s methods- the Method of Agreement, the Method of Difference, the joint Method of Agreement and Difference, the Method of concomitant variation and the method of residue.

Meaning of Causality

The word causality is derived from the Latin word ‘*causa*’ which means “cause, reason, interest, judicial process or law suit.” Causality can be defined as the relationship between cause and effect or the principle that everything has a cause.

Causality is an important concept in science. Explanation of phenomena is one of its major functions. Every scientific explanation is in fact, an explanation seeking “why” question. For instance, ‘why is the ocean blue in color?’ or ‘why was there heavy rain fall two weeks ago?’ etc. The ‘*why question*’ indicates the search for the cause of a phenomenon or an event. Therefore every scientific explanation is a causal explanation. In other words, it tries to bring out the cause-effect relationship.

There is a logical relationship between cause and effect. If the cause is present, then the effect is sure to come. Therefore, what is called ‘cause’ is a necessary or sometimes a ‘sufficient’ condition for the effect to occur. If we remove the cause, the effect is also not there. We take vaccine as the precaution to prevent some future diseases like polio and diphtheria. Thereby we remove the possible cause in order to prevent the effect that may follow.

We take lot of precaution to avoid certain unpleasant effect in our day to day life.



Activity 1

List such precautions involving cause-effect relations.

- *We vaccinate our children because we know vaccination will protect them from polio and diphtheria.*
-
-
-

Is the word 'cause' ambiguous?



The word 'cause' is often used ambiguously. For example, when we say that sprinkling water on the plant will cause them to grow we mean that water is required for growth. Water alone will not do the job. There are other factors like sunshine, proper soil, manure and the like.

Let us try to clear the ambiguity!!!

In order to remove the ambiguity of the meaning of 'cause' it is important to show what is meant by cause.

1. Sufficient condition
2. Necessary condition
3. Sufficient and necessary condition



Activity 2

Write examples of necessary conditions.

- It is necessary to have talent to become a world class sports player.
-
-

When we say that electric shock can cause death, we mean 'cause' in the sense of **sufficient** condition. Electric shock is sufficient to lead to death. But there are other methods equally effective such as poisoning, drowning, shooting, etc.



Activity 3

Write examples of sufficient condition

- Being born in India of Indian parents is a sufficient condition for obtaining an Indian passport.
-
-
-

On the other hand when we say that the presence of clouds is the cause of rain we mean, 'cause' in the sense of **necessary** condition. Without clouds rain cannot occur. But clouds alone are not sufficient. Certain combinations of pressure, temperature, wind etc. are also required.

Sometimes 'cause' is used in the sense of **necessary and sufficient** condition. We say that 'the action of a force causes a body to accelerate. That means nothing more and nothing less is required than force.'



Activity 4

Write examples of necessary and sufficient condition.

- 0° Temperature is necessary and sufficient condition for water to become ice.
-
-
-

Let us check



Identify the relationship between X and Y. (X is antecedent and Y is consequent).

- Mark A if it is a necessary cause.
- Mark B if it is a sufficient cause.
- Mark C if it is necessary and sufficient cause.
- Mark D if it is neither necessary nor sufficient cause.

1. X = Smoking cigarettes
Y = Developing lung cancer
2. X = Drunken driving above the legal alcohol limit in blood.
Y = will be convicted.
3. X = Having A+ in all subjects at Plus Two,
Y = make one eligible for degree courses in a college
4. X = Women winning a large majority of seats in the Indian Parliament
Y = Women forming a government.

Aristotelian view of cause

To answer various *Why* questions, Aristotle identified four types of causation. They are:

- Formal cause
- Material cause
- Efficient cause
- Final cause
- Material cause: the material from which a thing has come or that which persists while it changes, as for example, the bronze of a statue.



The Statue of Liberty was made of bronze.

- Formal cause, the shape or form into which a thing is made.



- Efficient cause, the agency that produces a thing, e.g. the agency which made the Statue of Liberty (the sculptor that made the statue).



Frédéric Auguste Bartholdi
1834-1904 French sculptor

- Final cause, the purpose or goal that determines the making of things, e.g. the purpose/end/goal of the statue.

The above statue is an icon of freedom and of the United States: a welcoming signal to immigrants arriving from abroad.

Let us check



Explain the picture in terms of Aristotelian view of cause.

.....

.....

.....

.....

Scientific View of Cause

From the point of view of modern science, J S Mill defines cause as ‘**the invariable and unconditional or necessary antecedent**’. That is, the totality of conditions of which the effect invariably and unconditionally follows. By analyzing Mill’s definition we can find out the characteristics of a scientific cause.

1. Cause is an antecedent.

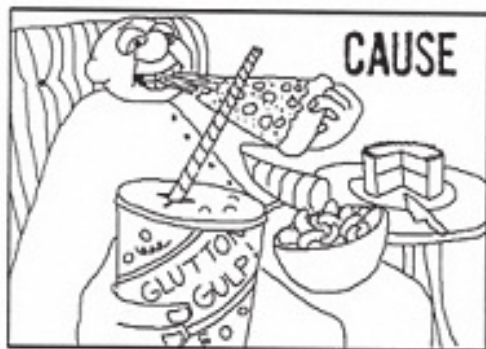

Find the conclusion for the following premises.

Cause is an antecedent.

Antecedent is that which comes first, precedes the effect.

∴

Can we say that which happens first as the cause? The cock crows before the day break. Will you say that crowing of the cock is the cause of the sunrise? It will be absurd. However cause happens first in the case, where there is cause-effect relation. But there is no time factor between cause and effect. In reality cause transforms into the effect.

“Post hoc ergo propter hoc.” = After this therefore, because of this.
It is a fallacy.

2. Cause is an invariable antecedent.

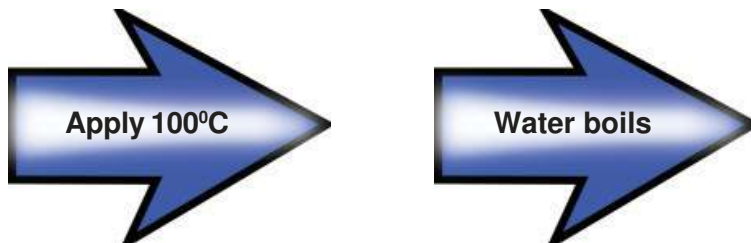

The cause must be present before the effect takes place without any fail. Whenever the water boils, 100 °c is applied invariably. Here invariability means the presence of cause before the effect every time.

Day comes always before night. Is night the cause of day? Thunder and lightning always go together but one is not the cause of other. Summer is not the cause of winter.

3. Cause is an invariable and unconditional antecedent of an effect

We have learnt that an invariable antecedent cannot always be called a cause. An antecedent to be called cause, it should also definitely be unconditional as in the case of fire and smoke.

Let us check

List out a few causes and effects in the light of the definition 'Cause is an invariable and unconditional antecedent of an effect.'

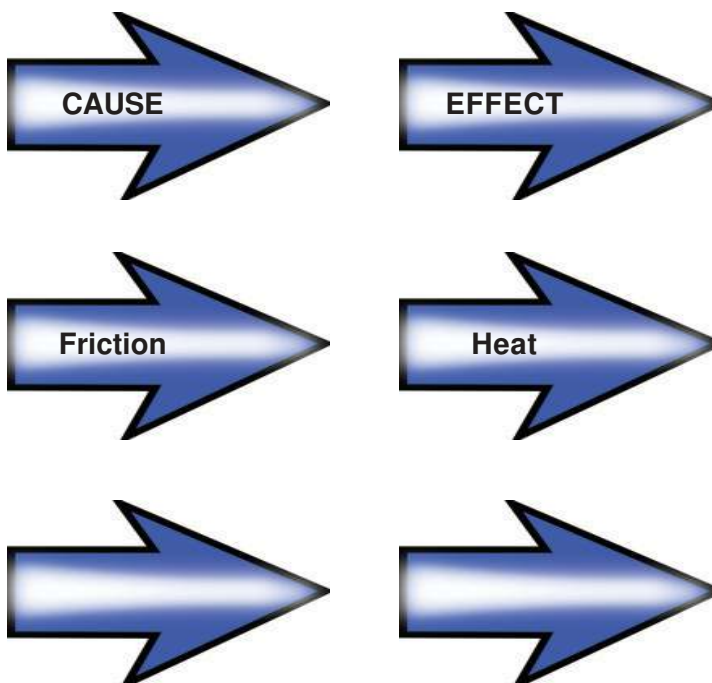

Mill's Experimental Method

In his '*System of Logic*' the nineteenth century philosopher John Stuart Mill compiled five methods for identifying causal connections between events. These he called:

- The method of agreement
- The method of difference
- The joint method of agreement and difference
- The method of residues
- The method of concomitant variation.



John Stuart Mill
(1806 –1873)

Mill's methods are meant for discovering the precise cause of events. This is done by a process of **analysis and elimination**. The phenomenon to be investigated is very often complex. Hence the first step in the determination of the cause of an event is the analysis of the event into separate factors and citing all the antecedent circumstances in detail. This is a difficult work that requires wide and deep knowledge of the given phenomenon. The next step is to find out the facts about the phenomenon that satisfy all the conditions of a true cause. This is done by a process of elimination. By applying definite rules of elimination, we exclude all the accidental and irrelevant circumstances.



The principles of elimination are:-

- That is not the cause of a phenomenon in the absence of which the phenomenon occurs.
- That is not the cause of the phenomenon in the presence of which the phenomenon fails to occur.
- That is not the cause of the phenomenon which varies when it is constant, or constant when it varies, or varies in no proportionate manner with it.
- That is not the cause of a phenomenon which is known to be the cause of another phenomenon

All the principles are obtained from the very definition of scientific cause, that is, cause and effect are co-present and co-absent.

1. The method of agreement



If two or more instances of the phenomenon under investigation have only one circumstance in common, the circumstance in which alone all the instances agree, is the cause (or effect) of the given phenomenon—John Stuart Mill

Analysis of the rule:

- There should be several instances of the phenomenon under investigation.
- The instance must be positive, i.e. those in which the phenomenon occurs.
- They have only one circumstance in common.
- The other circumstances are variable.

The invariable circumstance is the cause of the phenomenon.

Suppose that five people have dinner from a certain restaurant. A short while later all the five become sick. Assume that these people ordered variety of items from the menu. But the only food that all of them ordered was a vanilla ice cream. Such a situation suggests that the ice cream caused the sickness.

The method of agreement is a systematic effort to find a single factor (such as the ice cream). It is common to several occurrences. The purpose of identifying that factor is to find out the cause of a phenomenon present in the occurrences (such as the sickness).

The method of agreement identifies a cause in the sense of a necessary condition. To see how this method works, let us analyse the restaurant example in details.

Five people have dinner from a restaurant. Annamma takes salad, *biryani*, chappathi, ice cream and mixed vegetables. Bharathi has salad, *biryani*, soup, ice cream, fish and mixed vegetable, Chinnu has chappathi, soup and ice cream. Dhilshana has fish, mixed vegetables, ice cream, salad and soup. Emily has mixed vegetables, fish, ice cream, *biryani* and salad. Later all of them become sick from something they had.

Which food has caused the sickness?

In order to find out the cause (the common factor upon which all the instances of the phenomena under investigation agree) let us test the phenomenon through the process of analysis and elimination.

Logic and Reasoning

Distribute the data in the table given below.

1-5 stand for Annamma, Bhatathi, Chinnu, Dhilshana and Emily. A-G stand for salad, soup, *biriyani*, chappathi, fish, icecream and mixed vegetable respectively:

- Put a tick (✓) if certain food was taken and a dash (-) if it was not eaten.
- Find out the common factor (the cause of the sickness) and write it in the appropriate column.

(Annamma's food items is distributed in the table.)

Occurrence	A	B	C	D	E	F	G	Common factor
1	✓	-	✓	✓	-	-	-	
2								
3								
4								
5								

∴ The food that caused the sickness = _____.

Advantages

- The method of agreement has all the advantages of observation.
- In this method we can argue from effect to cause and from cause to effect.
- Its main application is in suggesting hypotheses about cause.

Limitations

- The method of agreement is not much useful if we are presented with a plurality of causes.
- This method helps us to discover the invariability of single antecedent, but not element of necessity.
- Method of agreement is mainly an observational method. This method takes in to account only positive instances

2. Method of difference



If an instance in which the phenomenon under investigation occurs, and an instance in which it does not occur, have every circumstance save one in common, that one occurring only in the former; the circumstance in which alone the two instances differ, is the effect, or cause, or an necessary part of the cause, of the phenomenon.

—John Stuart Mill,

Analysis of the rule:

- o In this method we observe only two instance of phenomenon - one positive and other negative.
- o They differ in only one circumstance.
- o That one circumstance should be present in positive instance and absent in negative instance.

This sole differing circumstance must be causally connected with the phenomenon.

For an example of how this method works, let us modify our earlier case of people becoming sick from eating food in a restaurant. Instead of those five people, suppose two who have identical chances to food poisoning, go to that restaurant for dinner. They both order identical meals except that, one orders ice cream while the other does not. The ice cream is the only way that the two meals differ. Later the two who ordered the ice cream get sick, whereas the other does not. The natural conclusion is that the ice cream caused the sickness.

The method of difference consists in a systematic effort to identify a single factor that is present in the phenomenon under study; and absent in which the phenomenon is absent. The method is confined to investigating exactly two occurrences, and it identifies a cause in the sense of a sufficient condition.

For a clearer illustration of how this method works, let us add a few details to the twin example:

Manu and Sanu, have dinner in a restaurant. The twins have identical chances of food poisoning. Manu orders soup, salad, chicken, carrots, rice and ice cream. Sanu orders soup, salad, chicken, carrots, rice and no ice cream.

Logic and Reasoning

What food caused Sanu’s sickness?

Distribute the data in the table given below.

1-2 are Manu and Sanu. A stands for the specific chance to food poisoning. B- G stand for soup, salad, chicken, carrot, rice and ice cream respectively:

- Put an tick (✓) if certain food was taken and a dash (-) if it was not eaten.
- Find out the differing factor (the cause of the sickness) and write it in the appropriate column.

Occurrence	A	B	C	D	E	F	G	Differing factor
1								
2								

∴ The food that caused the sickness = _____.

Group Discussion

Compare the Method of Difference with the Method of Agreement.

The Method of Agreement	The Method of Difference
•	•
•	•
•	•
•	•
•	•

The Joint Method of Agreement and Difference.

If two or more instances in which the phenomenon occurs have only one circumstance in common, while two or more instances in which it does not occur have nothing in common save the absence of that circumstance; the circumstance in which alone the two sets of instances differ, is the effect, or cause, or a necessary part of the cause, of the phenomenon. —John Stuart Mill,



Analysis of the rule

- o In this method, we require two sets of instance. In the first set of positive instances the single common circumstance is detected. If the single common circumstance present in the first set is found absent in the second set of negative instances that is the probable cause of the given phenomenon.
- o The instances must be as far as possible from the same field.
- o The causal conclusion is based on the uniform presence of a condition in the positive set and its uniform absence in the negative set.
- o The joint method is also called the Double method of agreement because its conclusion is based on a double agreement, i.e., the agreement in presence and the agreement in absence.

Also called simply the “joint method, “ this principle simply represents the application of the methods of agreement and difference.

Look at the example of joint method. Six people have dinner from a restaurant. The first three have a variety of meals, but only ice cream is consumed by all. Later all three get sick. The other three also have a variety of meals but without any ice cream. None of them gets sick. The conclusion is warranted that the ice cream is what made the first three diners sick.

The joint method of agreement and difference consists of a systematic effort to identify a single condition that is present in two or more occurrences in which the phenomenon in question is present and that is absent from two or more occurrences in which the phenomenon is absent. But never present when the phenomenon is absent or absent when the phenomenon is present. This condition is then taken to be the cause of the phenomenon in the sense of a necessary and sufficient condition.

To see more clearly how this method works, let us add some details to the example:

Manoj has soup, chappthi, ice cream, *vada* and mixed vegetables. Tom has salad, soup, fish, mixed vegetables and ice cream. Sruthy has salad, chappathi, *vada* and ice cream. Kumar has *vada*, chappthi and salad. Sana has fish and mixed vegetable. Jose has *vada*,

Logic and Reasoning

chappathi and soup. Later Manoj, Tom and Sruthy become sick from something they had, but Kumar, Sana and Jose do not have any problems.

What food may have made the first three diners sick?

Distribute the data in the table given below.

1-6 stand for Manoj, Tom, Sruthy, Kumar, Sana and Jose. A- G stand for salad, soup, chapathi, fish, ice creame, *vada* and mixed vegetables.

- Put an tick (✓) if certain food was taken and a dash (-) if it was not eaten.
- Find out the agreeing and differing factor (the cause of the sickness) and write it in the appropriate column

Occurrence	A	B	C	D	E	F	G	Common and differing factor
1								
2								
3								
4								
5								
6								

∴ The food that caused the sickness = _____.

- List the advantages of the joint method of agreement and difference over the other two methods.

4. Method of concomitant variations

The method of concomitant variations identifies a causal connection between two conditions by matching variations in one condition with variation in another.

Suppose increase of poverty in society shows a corresponding increase in crime. Therefore, we say that they are causally connected.

"Whatever phenomenon varies in any manner whenever another phenomenon varies in some particular manner, is either a cause or an effect of that phenomenon, or is connected with it through some fact of causation"



- John Stuart Mill.

Analysis of the rule

- o We take two phenomena that always vary together.
- o The variations are uniform.
- o They must be in the same direction, i.e., either in direct or in inverse proportion.

There is a variation in time, size and strength of the tides whenever there is a variation in the faces of the moon. Therefore, there is a causal connection between the faces of the moon and the changes in tides.

2. Method of residue

This method is used to identify a causal connection between two conditions without regard for the specific kind of connection. The method of residue consists of separating from a group of causally connected conditions the strands of causal connections that are already known. It leaves the required causal connection as the "residue."

Here is an example:

After occupying his new house, Mr. Smith found it uncomfortable. He traced three conditions: a broken window in the garage, a crack under the front door, and a broken damper in the fireplace. When the window was replaced he noticed an improvement and a further improvement when weather stripping was installed on the door. He concluded that the draft that remained was caused by the broken damper in the fireplace.

The method of residues as illustrated in this example may be presented as follows.

A B C causes a b c
 A causes a
B causes b
 ∴ C causes c

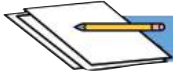

Summary

- Causality can be defined as the relationship between cause and effect or the principle that everything has a cause.
- Aristotle identified four types of causation. They are formal cause, material cause, efficient cause and final cause
- J S Mill defines cause as ‘the invariable and unconditional or necessary antecedent’.
- John Stuart Mill compiled five methods for identifying causal connections between events. They are:
 - The method of agreement
 - The method of difference
 - The joint method of agreement and difference
 - The method of residues
 - The method of concomitant variation.



I can

- recognise the ambiguity of the word cause.
- make use of Mill’s experimental methods to find the cause of phenomena.
- analyse the phenomena under investigation and eliminate non-essential circumstances.



Let us assess

Exercise 1

1. Identify which of Mill’s methods is used to support the conclusion.

Part of the damage to the aircraft could be attributed to its impact with the ground. Another part was definitely due to the wind that the plane experienced as it fell from the sky. However, some of the damage cannot be accounted for by either of these

factors. Investigators are examining this evidence closely for evidence of explosives.

- a. Method of Agreement
- b. Method of Difference
- c. Method of Concomitant Variation
- d. Method of Residue

2. Identify which of Mill's methods is used to support the conclusion.

No college wrestler has died in fifteen years until now. Why did Rocky die? He was using creatine?

- a. Method of Agreement
- b. Method of Difference
- c. Method of Concomitant Variation
- d. Method of Residue

3. Identify which of Mill's methods is used to support the conclusion.

Charles worked for two years at a hospital. During this time, the number of deaths increased dramatically.

- a. Method of Agreement
- b. Method of Difference
- c. Method of Concomitant Variation
- d. Method of Residue

4. Identify which of Mill's methods is used to support the conclusion.

At first we could not determine the cause, but then we noticed that there were more cases of infection when more monkeys from Uganda were present.

- a. Method of Agreement
- b. Method of Difference
- c. Method of Concomitant Variation
- d. Method of Residue

Exercise 2

1. Explain the following picture in terms of Aristotle's view of cause.



2. In a seminar it is stated that 'the Joint Method of Agreement and difference' has all the advantages of 'the Method of Agreement' and the Method of Difference'. Do you agree with the above statement? Substantiate.



HYPOTHESIS

KEY CONCEPTS

- The role of hypothesis in our life
- A proper definition to hypothesis
- Conditions of a valid hypothesis
- Formulation of hypothesis
- Types of hypothesis
- Working hypothesis
- Barren hypothesis
- False hypothesis
- Crucial experiment



In this chapter we study about hypothesis. Hypothesis has crucial role in scientific induction. You will be able to formulate a sound and working hypothesis while searching for the cause of phenomena. The conditions of working hypothesis are also detailed in this chapter.

The Definition and Meaning of Hypothesis

Look at the picture.



- What do you infer from this picture?
- What are the reasons for this situation?

The mental activity that went on in finding out the cause of the phenomenon was a real guess work. We make similar guesses in our day-to-day life. Guess always indicates the tentative cause of phenomena. The guess work to explain the cause of a phenomenon is called hypothesis.



Activity 1

Mention an instance from your life about which you formed guesses.

Instance:

.....

List your guesses regarding the above instance shown in the picture.

Guess 1.

Guess 2.

Guess 3.

Guess 4.

In scientific knowledge hypothesis has a very significant role. **Hypothesis is a tentative explanation of the observed facts.** A scientist frames a hypothesis and then deduces a conclusion from it. The conclusions deduced must agree to facts. If they do so, the hypothesis is true and it does work. It is the outcome of the co-operation of the intellect and imagination. Hypothesis is a supposition and an educated guess work. Here the term educated means, no good hypothesis can be developed without research into a problem.

The term hypothesis comes from two Greek words. It means a temporary statement. The prefix '*hypo*' means under and "*thesis*" means *placing*. So a hypo-thesis can claim only a lower status to a thesis.

According to Prof. Coffey, "A hypothesis is an attempt at explanation; a provisional supposition made in order to explain scientifically some fact or phenomenon". This definition shows the fact that hypothesis is the crucial step in the inductive process of establishing the universal law regarding a phenomenon.

According to Cohen and Nagel "a hypothesis, directs our search for the order". It is not essential for a hypothesis to be necessarily true. In fact hypothesis is not a claim of truth but a claim for truth. Hypothesis is a bridge in the process of inquiry or search that begins with some felt difficulty of a problem and ends with the resolution of the problem.



Mill has defined hypothesis as "any supposition which we make in order to endeavour, to deduce conclusions in accordance with facts which are known to be real under the idea that if the conclusion to which the hypothesis leads are known truths, the hypothesis itself either must be or at least likely to be true"

According to Newton "Hypothesis non fingo" which means I do not invent or frame hypothesis. We should never form our hypothesis out of imagination or insufficient data. It does not mean that we should not frame any hypothesis. A Hypothesis must be consistent with what we already know about the nature of facts. Then our knowledge is imperfect and hence it keeps on progressing. When new knowledge comes up we have to modify the old established truths in the light of the new Hypothesis.

Thus in our day-to-day life we always make suppositions to explain facts, which come to our own experience. For example: Mohan, who has been a good student, is at present weak in his studies. His teacher makes an assumption or hypothesis that it may be due to lack of concentration or adverse family situations.

Write down your hypothesis for the following facts.



Activity 2

FACTS

The bus did not arrive today

Sensex falls

Infant mortality rate increases

AAP wins Delhi elections

HYPOTHESIS

Sources or Origin of Hypothesis



Hypotheses are attempts to explain phenomena. But the actual framing of hypotheses is the work of an inventive genius. It is here that the knowledge, genius and originality of scientists get their free scope. It is by a flash of genius or inspiration that great scientific theories have been discovered. The invention of scientific hypothesis cannot be due to an observance of a set of rules.

We may consider the principal ways in which hypotheses are suggested. They are

Analogy:-Analogy is the most fruitful source of hypothesis. It is based on superficial resemblance between two things. It is observed that two things resemble each other in some important respects. On the basis of this observation, a hypothesis is framed that will resemble each other in many other respects also. For example, the wave theory of sound was suggested by the instance of water waves.

Creative Imagination:- Imagination plays a very important role in the formation of a hypothesis. A hypothesis is built on the ground of observation of facts and with imagination. Every truthful hypothesis has its origin in the investigator's imagination.

Wide knowledge:-All our imaginations require a vast field of knowledge concerning the field of enquiry. It is meaningless to start thinking about the problem under consideration if we do not have a pre knowledge. A scientist's mind is preoccupied with a certain problem and goes on gathering relevant information about it.

Insight:-Though much effort is required before the formation of a hypothesis, usually the right solution comes in a sudden flash of insight.

Simple Enumeration:- It is regarded as a source of hypothesis. Here we count some of the instances of a class and make a general statement about all the instances including the unobserved cases. This generalisation helps to formulate hypothesis.

Formation Of Hypothesis

Hypothesis is the stepping stone in scientific induction. Before a general law is discovered and proved, we must start with a provisional supposition. In scientific induction we begin with observation and description of facts. Even at the stage of observation, hypothesis is necessary to guide and control our perception.

Four stages in Scientific induction

1. Observation of fact
2. Formation of hypothesis
3. Verification
4. Proof



Verification

The formation of hypothesis is the second stage in inductive process. The hypothesis formed in the course of analysis must be verified by relating them to actual facts. Then only we can conclude which of the hypotheses is true. This is the process of verification, and it helps us to select the correct hypothesis and to avoid wrong ones. Verification of hypothesis consists in finding out whether it is in agreement with facts. If it agrees to facts, it may be accepted as the explanation of facts. Hypothesis is verified either directly or indirectly. **Direct verification** consists in direct observation or experiment. **Indirect verification** consists in deduction and accumulation of consistent facts. Verification is direct, when a direct appeal to the facts of experience confirms the hypothesis in question. Here the appeal to fact is not through a deduced consequence. It may be done by simple experiment.

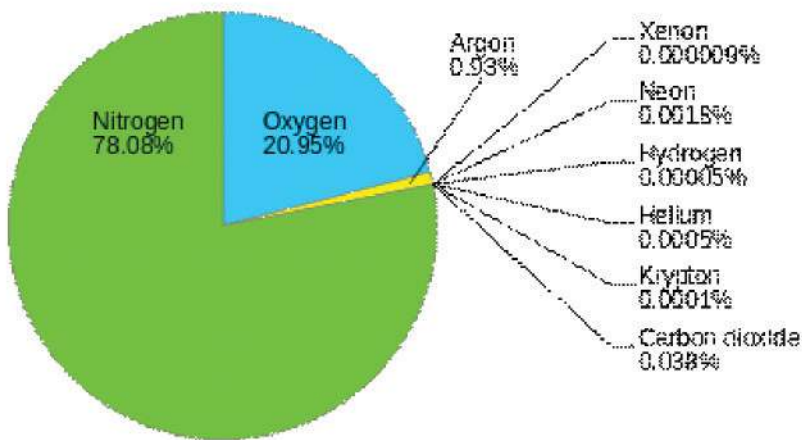

Experiment is also a means to verify a hypothesis. It was found that oxygen obtained from the atmosphere was slightly heavier than the oxygen obtained from other sources. So, scientists framed the hypothesis that the atmospheric oxygen was mixed up with certain other gases. By experiment it was shown that in the case of atmospheric oxygen, when oxygen was eliminated there remained a residue. Thus the hypothesis is verified by experiment.

Verification may sometimes be indirect. When direct observation or experiment cannot be applied we deduce consequence from the hypothesis and compare the consequence with the actual facts. There are certain cases, for instance, which by their very nature, cannot be perceived by senses. In such cases we deduce consequence from them and compare them with facts. If the deduced consequence agrees to the facts directly

observed, the hypothesis is verified. If they do not agree the hypothesis is disproved. If a large number of facts consistent with the hypothesis are present and contradictory ones are absent, the hypothesis is verified to some extent. At the final stage, the verified hypothesis is tested to show that it is the only sufficient explanation of the given phenomenon. The same fact may be explained by different theories, but only one can be the apt one. Thus the proven hypothesis becomes a law.

Characteristics of good Hypothesis

All hypotheses are not equally good. Some are wild guesses, while others are attempt to explain facts. Scientists want to ignore the former. So certain criteria are laid down for distinguishing good hypothesis from bad one. A good hypothesis needs the following criteria.

- A hypothesis should match with previously established laws. Every hypothesis has to find a place in the system of laws already established by a science. So it should be compatible with the existing knowledge.
- Relevance. The function of hypothesis is to explain the facts which have become a problem. It can serve this propose only if it is relevant. Relevant hypothesis means one from which the facts to be explained can be deduced.
- Self consistency. A hypothesis must not be inconsistent. There must be no contradiction among the different elements.
- A hypothesis must be capable of deductive development. It must be formulated in such way that consequences can be deduced from it. By discovering what a hypothesis implies one can find out whether it offers a satisfactory solution to the problem.
- Testability. A hypothesis is a first format for explaining the observed facts. So before a scientist can consider it seriously, he must find out whether the hypothesis is testable (verifiable).
- A good hypothesis should be believable and not be absurd: If a hypothesis is framed on the basis some belief rather than on scientific data, it may possibly lead to absurdity. For example, natural calamity is due to the fury of gods. Such hypothesis does not yield a scientific conclusion.
- Hypothesis must be verifiable: It may be tested directly or indirectly. Usually a hypothesis is accepted or rejected through experimentation or observation. If a hypothesis is accepted it becomes a theory. A scientific theory summarises a hypothesis or group of hypothesis that has been proved with repeated testing.

Logic and Reasoning

- **Simplicity:** Simplicity can be yet another criterion for evaluating scientific hypothesis. Among two hypotheses, the simpler is chosen. Simplicity seems to be a natural criterion to invoke.

Different Types Of Hypotheses

Working hypothesis

Read the following news paper report.



Global temperatures to rise 4 degrees by 2100

MELBOURNE (Jan 1, 2014): Global average temperatures will rise at least



4 degrees Celsius by 2100 and potentially more than 8 degrees by 2200 if carbon dioxide emissions are not reduced, a new research has warned.

Scientists found global climate is more sensitive to carbon dioxide than most previous estimates.

The research also appears to solve one of the great unknowns of climate sensitivity, the role of cloud formation and whether this will have a positive or negative effect on global warming.

- Identify the guess implied in the news.
.....
- How did the scientists find the assumption that global temperature would increase by 2100?
.....

A Working Hypothesis is an explanation, though inadequate, accepted for further investigation. A working hypothesis does not claim to explain facts. It is accepted only as a starting point to a new investigation. Working Hypothesis is a legitimate and meaningful hypothesis. A Working Hypothesis can always be verified. Any Working Hypothesis is accepted for a short period only. It is subject to change, modification, acceptance or rejection, depending on how far it is truthful.

Sir Isaac Newton framed a hypothesis when a sitting passenger fell forward when the bus suddenly stopped. This hypothesis became Newton's First Law. That is, body is incapable to change by itself from its state without an external agent (inertia).

Barren Hypothesis



Ashok: Oh! This is due to the curse of God.

Amal : What???

Do you think the guess of Ashok can be verified?

A hypothesis which leads nowhere is called Barren Hypothesis. It may be either true or false. It is a meaningless and invalid assumption about the cause of an observed phenomenon. It is an irrational explanation and cannot be verified. A Barren Hypothesis is not a legitimate one because it is contradictory to a Working Hypothesis. Similarly, if one says that his serious disease is his fate, it is a case of Barren Hypothesis.



False Hypothesis

It is a supposition, which is proved to be false. False hypothesis is verifiable but after verification it is found to be false. A false hypothesis is rejected and a new one is framed in its place to explain the phenomenon. It can be stated that a false hypothesis is always capable of verification, but it will fail the test of verification.



For example: A player is given out as LBW. The third umpire verifies the decision and declares LBW was wrong. This is an example of false hypothesis.

Let us check



Activity

1. Write an example of a False Hypothesis.
2. Write an example of Barren Hypothesis

.....

Rival Hypothesis

All the hypotheses cannot be true. Sometimes it also happens that two different hypotheses fully explain some set of facts and both are testable, both are compatible, with the whole body of already established scientific theory. They are called Rival Hypothesis.

To arrive at a true hypothesis and to reject the false one, we take the help of crucial instance. The crucial instance helps to decide between two rival hypotheses. Sometime we have to depend upon certain experiments to find out the final validity of one of the hypotheses. Here the crucial instance is obtained by experiment it is called a **crucial experiment**. Many of the scientific theories finally established their validity with the help of crucial experiments. When a hypothesis is both verified and also proved it is called an **established law**.

There will be lot of circumstances in life when we will be struggling for solutions. In such situations there may arise an instance which would lead us to a solution of the problem. That apt instance is known as **crucial instance** if we stick on to the crucial instance the problem would be solved.

Suppose a man feels high fever. Three experienced doctors examine the patient. But each gives different opinion about the disease. A crucial instance is chosen to arrive at the true diagnosis. The blood of the patient is observed under a microscope. It reveals Malaria germs. Naturally, the other theories about the patient's fever are rejected and he is treated for Malaria.

Another well known example is the story of Queen Sheba and King Solomon. Queen Sheba placed at a distance two flowers, one natural and the other artificial. They looked alike. The queen wanted to test the wisdom of Solomon. She asked Solomon to identify the original flower. King Solomon asked to keep all the windows open. After some moments bees entered the room and settled down on the original flower. In this example the arrival of bees is the crucial instance. It helped the king to identify the original flower.

Crucial Instance (Example)

University Campus

Examination Section
(Block No. 3)

Academic Section
(Block No. 4)

Library
(Block No. 1)

Philosophy Department
(Block No. 2)

Rajeev Kumar reaches the University campus. He first sees a few blocks of buildings. He looks for the Department of Philosophy. He takes a few steps forward and finds the sign boards towards various blocks. He follows the sign boards guiding to the department of philosophy. Can you find out crucial instance in the above example of Rajeev Kumar? Have you ever gone through such an instance in your life? What was the crucial instance that helped you?

Evaluating scientific Hypothesis



1. Relevance
2. Testability
3. Compatibility
4. Predictive power
5. Simplicity
6. Deductive development
7. Self-consistency

Fact

Concrete event of experience

Hypothesis

Unverified guess

Theory

When a hypothesis is verified and thus acquiring a fair measure or probability it becomes theory

Law

When a theory is proved to be true with reference to facts it becomes a law

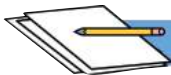

Summary

- Hypothesis is a tentative explanation of the observed facts.
- The standard value of hypothesis is lower than theory.
- Scientific induction starts with provisional supposition. So hypothesis plays an important role in scientific induction.
- A verified hypothesis is known as a theory; a proven hypothesis is called a law.
- Working Hypothesis is a legitimate and meaningful hypothesis. It is always verified. But Barren Hypothesis is meaningless and invalid. False Hypothesis is verifiable one. But after verification it is found to be false.
- Crucial instance helps us to decide between two rival hypotheses.
- A good hypothesis must be believable relevant and compatible.



I can

- identify the importance of hypothesis in daily life.
- find out the specific features of hypothesis and give definitions to them.
- choose the valid hypothesis.
- differentiate between various kinds of hypotheses.
- identify the crucial instance in life.



Let us assess

1. Write a definition for hypothesis.
2. When a gun is fired the bullet goes out in forward direction while the gun moves in the backward direction (Newton's Third Law).
Guess the hypothesis explaining this phenomenon.
3. "Dengue fever is caused by the living conditions of the patient".
Do you agree to this hypothesis?
Mention the name of the hypothesis.
4. Nikitha visited a village. There was an outbreak of chicken pox. An old lady from that village told her that chicken pox was caused due to God's anger.
What is your opinion about the old lady's hypothesis and name it?
5. Look at the image.



Logic and Reasoning

What hypotheses can be derived after looking at the image?

Write them in the space below.

- a.
- b.
- c.
- d.
- e.

9

SYMBOLIC LOGIC

KEY CONCEPTS

- Symbols in daily life
- Definition of symbolic logic
- Classical and modern logic
- Truth functions and truth Tables
- Conjunction
- Disjunction
- Implication
- Negation
- Material implication

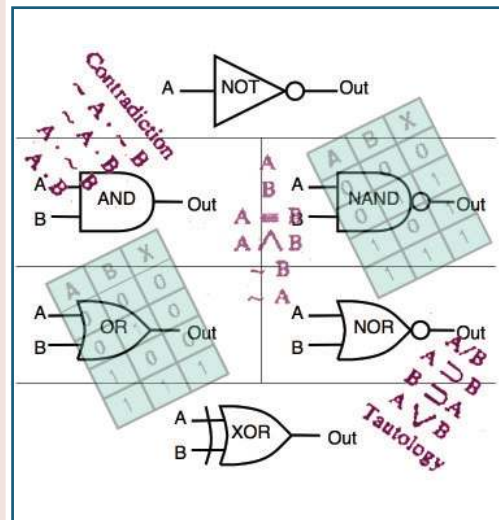

This chapter is an attempt to introduce modern logic. There is scope for symbolising ordinary sentences using variables and constants. The truth value of the propositions is evaluated using truth tables. The truth functions such as conjunction, disjunction, implication, negation and material implication are discussed. The chapter also introduces logic gates.

Logic and Reasoning

Symbols in daily life



Identify the following symbols and name their class in the blank box.

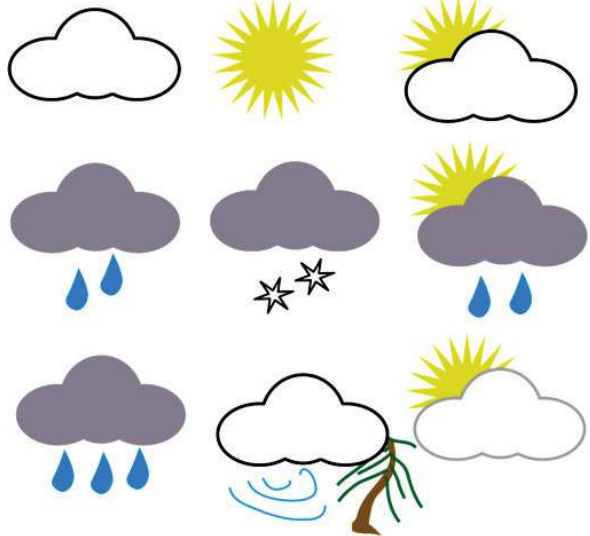



“Because language is misleading, logical symbolism is absolutely necessary to any exact or thorough retreatment of our subject.”

- Bertrand Russel





A brief history of symbolic logic

Aristotle laid the foundation of logic as a science. Since then for nearly two thousand years his work and his style of reasoning had dominated the field of logic. In the seventeenth century G.W. Von Leibniz, a mathematician turned philosopher, saw that Aristotelian and his contemporaries' style of reasoning needed modification. But he merely suggested, and never showed the direction which logic possibly could take.

It is only in the nineteenth century that the thinkers started actualizing the ideas of Leibniz. This is mostly because of rapid development in Mathematics and its use in logic. Since Newton's discovery of Differential Calculus, Mathematics developed rapidly. Very soon, it became the 'key-science'. The other branches of knowledge started using mathematical techniques in their studies. Logic also joined the race.

Logic thus became more fundamental and basic than mathematics. It started using logical properties. Modern mathematics, modern algebra, the set theory are just few examples of it. Logicians too became busy in showing logic as the foundation of mathematics. Bertrand Russell and A.N. Whitehead's *Principia Mathematica* is leading example of it.

Modern logic is a further development of traditional logic. In the classical logic the formulas were small and so were the patterns of valid inference. But at the same time it is not wrong to say that what was implicit in Aristotelian logic has become explicit in modern logic.

Definition of Symbolic Logic

Logic is concerned with arguments which contain propositions or statements as their premises and conclusions. The communication of propositions and arguments requires the use of language. Difficulties arise as words in languages may be ambiguous. The construction of phrases and sentences can be complex. Idioms can be misleading and the style can be metaphorical. To avoid some of the difficulties, specialized technical vocabularies have been developed. For example, in Mathematics: $A \times A = A \times A \times A$
 $A = B \implies B = B$ can be expressed as $A^7 = B^3$. Similarly, logicians have also developed symbols. In symbolic language, there are exceptionless rules for operating on, and within, a language.



The invention of symbolic logic is comparable to the replacement of Roman numerals by the Indo-Arabic notation. Indo-Arabic numerals are clearer and easier than the Roman numerals. For example, any student can easily multiply 113 by 9. But to multiply CXIII by IX is a difficult task. To quote Alfred North Whitehead, one of the great contributors to symbolic logic,

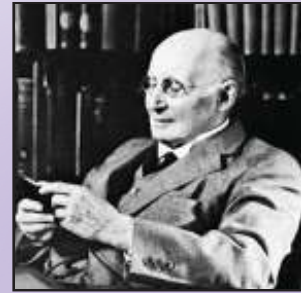

Alfred North Whitehead

“...by the aid of symbolism, we can make transitions in reasoning almost mechanically, by the eye, which otherwise would call into play the higher faculties of the brain.”

Classical and modern logic: their characteristics.

Analysing and appraising of an agrument is often difficult - Why?



What do we do to avoid these difficulties?

We move directly to the logical structure of an argument.

Logicians construct an artificial symbolic language, free of linguistic defects.

With a symbolic language we formulate an argument with precision.



In order to avoid the inadequacies of the natural language for purposes of logical analysis, it is necessary, first to translate into a more exact notation - *Alonzo Church*.

Listen to the conversation between Amal and his teacher.

Amal : *Did ancient logicians use logical symbols?*

Teacher : *Certainly.*

Amal : *Could you please give an example?*

Teacher : *Of course, Aristotle used variables. You have studied “All S is P” for “All men are mortal.”*

Amal : *Then what is the focus of modern logic ?*

Teacher : *The focus of modern logic is the internal structure of propositions and arguments.*

Amal : *Sir, please explain it.*

Teacher : *Classical logicians did understand the enormous value of symbols in analysis . Aristotle used symbols as **variables** in his own analysis. The refined system of Aristotelean syllogism uses symbols in very sophisticated ways. For example, ‘All s is P.’ The notion of variable is an important contribution of Aristotle to logic. A variable is a symbol that can stand for any one of the given range of values.*

Example $Y^3 = 8$. Here Y is a variable.

The modern symbolism greatly differs from the classical. Modern logicians look to the internal structure of propositions and arguments and to their logical links. In modern logic, we use various symbols. Symbols represent **constants and variables**. Constants are logical operators.

You know what the symbols, +, - and \times in mathematics imply. They are operators. In the same manner there are logical constants in symbolic logic. They are logical operators or links like, dot (.) vedge (V), horse shoe (\supset), tripple bar (\equiv), curl (\sim).

Variables and constants in symbolic logic form the basis of propositional calculus. Variables are symbols whose meaning varies. Where as constants are symbols whose meaning is constant. They are also known as sentential connectives.

In mathematical logic, a propositional calculus or logic (also called sentential calculus or sentential logic) is a formal system in which formulas of a formal language may be interpreted to represent propositions.

What is Boolean Algebra?

Boolean Algebra is a logical calculus of Truth values. It deals with two values True or False (or 1,0) variables. In practice electronic engineers view the symbol

'1' to refer to the values of the signal produced by an electronic switch as 'on' or True.

Zero '0' to refer to the values of the signal produced by an electronic switch as 'off' or False.

Symbol '0' and '1' are called bits.

Symbolic logic is also known as Boolean logic.

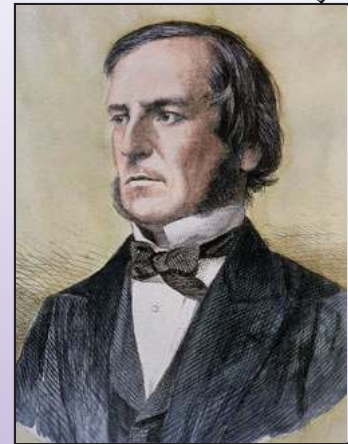

*George Boole
(1815-64)*

Thus we can define symbolic logic as the method of representing logical expressions through the use of constants and variables, rather than ordinary language expressions. It removes the ambiguity of ordinary languages. It tries to study the form of thought abstracted from all content.

Logic and Reasoning



Activity 1

Complete the following table using the information from the above interaction.

Characteristics of Classical logic	Characteristics of Modern logic
•	•
•	•
•	•
•	•
•	•

Logical form

We have already learned to reduce sentences into logical form.

Let us see how we convert the given statements into symbolic form.

E.g. The blind prisoner has a red hat or the blind prisoner has a white hat = B - R or B - W

This involves the logical process of presenting complicated sentences into shortened logical forms.



Activity 2

Convert the following into symbolic form:

1. If election is declared, then govt cannot enact new bills.
.....If E then G.....
2. A smoker kills himself and he kills others.
.....
3. India is not an aristocratic country.
.....

Can you list out the advantages of presenting sentences into symbolic form?

-
-
-

Truth Function

Truth function is a compound sentence of its component parts. For example- 'Charlie is sweet '(p)', Charlie is neat '(q)' are 2 simple components of Charlie is sweet and Charlie is neat (p and q). Thus '**p and q**' is the truth function of its component parts 'p' and 'q'.

We know that every statement is either True or False. This **status of any statement as True or False (T or F) is the truth value of the given statement**. Therefore we say that every statement has a truth value. The truth value of a true statement is True, and the truth value of a false statement is False. Using this concept, we can divide compound statements into two distinct categories. The truth value of compound statement is determined wholly by the truth value of its components.

Truth Table

Truth Table is the logical device to demonstrate all possible truth values of compound statements. It displays all possible combination of the truth values of the simple components.

How can we find all the possible combinations of a truth function?

Simple propositions has two possible truth values. They are True and False. These values are also represented with the binary digits 0 and 1 in logic gates. We will study them at the end of this lesson.

Let us consider the statement 'Rome is the capital of Italy'. This simple sentence may be either True or False.

Let us consider another statement 'Rome is the capital of Italy and Paris is the capital of France' which has two components.

How many possibilities will be there in the above statement?

There is a formula, to find out the number of possibilities, i.e. 2^n .

Here 2 stands for the two possibilities (T & F) of a component and 'n' stands for the number of variables.

Therefore the number of possibilities in the statement 'Rome is the capital of Italy and Paris is the capital of France

$$\begin{aligned}
 &= 2^2 \\
 &= 2 \times 2 \\
 &= 4
 \end{aligned}$$



Activity 3

Consider the following statements.

‘Rome is the capital of Italy, Paris is the capital of France and London is the capital of England’.

- How many components are there in the above statement?’
- Find out the possibilities of truth values.

We have learned that two component statements have four possible truth values. Now, let us see how we can represent it in a table.

p	q	p and q
T	T	T
T	F	F
F	T	F
F	F	F

First two columns represent component parts. The third column represents the compound statement. The truth value of ‘p and q’ is determined by the truth value of its component parts ‘p’ and ‘q’. The tabular representation we have just learned shows the truth function of conjunction. In the same way, different statements like negation, disjunction and implication have their own truth functions.

Let us discuss them in detail.

Look at the following table showing the fundamental logical constants.

Operators	Symbols/ Connectives	Name of symbol	Meaning of Symbols	Remarks
Negation	~	Curl	not	The tilde(~) is also often used
Conjunction	.	Dot	and	The ampersand (&) or dot (·) are also often used
Disjunction	v	Vee	either, or	This is the inclusive disjunctive, equivalent to and/or in English
Implication	\supset	Horse shoe	if...then	The horseshoe (\supset) is often used.
Material equivalence	\equiv	Triple Bar	If and only if	Biconditional

There are several types of compound statements each requiring its own logical notation. The first type of compound statement to be considered is the conjunction.

Conjunction

We can form the conjunction of two statements by placing the word "and" between them. The two statements so combined are called conjuncts.

The conjunction is a truth-functional compound statement. So the dot symbol is a truth functional conjunctive.



JUNCTION

Questions

You are given two statements p and q .

What are their possible sets of truth values ?

The four possible cases and the truth value of the conjunction in each, can be displayed as follows:

Where p is true and q is true $p \cdot q$ is true.

Where p is true and q is false $p \cdot q$ is false.

Where p is false and q is true $p \cdot q$ is false

Where p is false and q is false $p \cdot q$ is false

<i>p is True</i> The flower blossoms and fragrance comes out.	<i>q is True</i>	$p \cdot q$ is True	T
<i>p is True</i> The flower blossoms and fragrance does not come out.	<i>q is False</i>	$p \cdot q$ is False	F
<i>p is False</i> The flower does not blossom and fragrance comes out.	<i>q is True</i>	$p \cdot q$ is False	F
<i>p is False</i> The flower does not blossom and fragrance does not come out.	<i>q is False</i>	$p \cdot q$ is False	F

How can we construct a truth table ?

p	q	$p \cdot q$
T	T	T
T	F	F
F	T	F
F	F	F

Columns 1 and 2 express values of constituent propositions and column 3 the value of conjunctive preposition. The value of 3 is determined by the values of 1 and 2.



A conjunction is true if and only if both of its conjuncts are true ($T + T = T$). English words but, yet, also, still, although, however, moreover and even the comma and the semicolon are also used to conjoin two statements into a single compound statement. In their conjunctive sense they can all be represented by the dot.

A compound statement is true if both its components are true and a compound statement is false if both its components are false. Let us examine the statement 'John lives in England but his wife lives in India.'

The statement is true only if it is true that John lives in England and his wife lives in India.

Disjunction

The disjunction or alternation of two statements is formed in English by inserting the word or between them. The two component statements so combined are called disjuncts (or alternatives).

The English word 'or' is ambiguous with two related but distinguishable meanings. One of them is exemplified in the statement.



Activity 4

Discuss in groups and find out the possible meanings of the sentences.

“Premiums will be waived in the event of sickness or unemployment”. [The intention here is that premiums are waived not only for sick persons and for unemployed persons but also for persons who are both sick and unemployed.]



The above four persons are good friends

- The first person is sick and unemployed Premium will be waived
- The second person is sick but employed Premium will be waived
- The third person is not sick but unemployed Premium will be waived
- The fourth person is not sick but employed Premium will not be waived

<i>p is True</i>	<i>q is True</i>		
The first person is sick and unemployed.		$p \vee q$ is True	T
<i>p is True</i>	<i>q is False</i>		
The second person is sick but employed.		$p \vee q$ is True	T
<i>p is False</i>	<i>q is True</i>		
The third person is not sick and unemployed.		$p \vee q$ is True	T
<i>p is False</i>	<i>q is False</i>		
The fourth person is neither sick nor employed.		$p \vee q$ is False	F

The word 'or' used in disjunction is either weak or inclusive. An inclusive disjunction is true in case one or the other or both disjuncts are true. If both disjuncts are false, their inclusive disjunction will also be false. The inclusive 'or' has the sense of possibly both. Where precision is very important as in contracts and other legal documents, this sense is made explicit by the use of the phrase 'and/or.'



The word 'or' is also used in a strong or exclusive sense. The meaning is not 'at least one' but 'at least one and most one' For example, a restaurant lists salad or ice-cream on its dinner menu. It is clearly meant that for the stated price of the meal, the dinner may have one or the other **but not both.**



It is customary to use the initial letter of the word 'vel' to stand for 'or' in its weak inclusive sense. For example, p and q or any two statements, their weak or inclusive disjunction is written $p \vee q$. The symbol for inclusive disjunction (called a 'wedge', or less frequently a 'vee') is also a truth-functional connective. A weak disjunction is false only in case both of its disjuncts are false. We may regard the wedge as being defined by the following truth table.

p	q	$p \vee q$
T	T	T
T	F	T
F	T	T
F	F	F

As the table shows a disjunctive proposition is false only when both the disjunctives are false. In all the other cases it is true.

Using the letters A, B, C and D to shorten the simple statements; 'Kerala wins the tourism award', 'Haryana wins the tourism award', 'Wayanad wins the ecotourism award', and 'Kumarakom wins the ecotourism award'.

- If A and C are True, B and D are False, find out the truth value of the statements:

Either Kerala wins the tourism award and Haryana wins the tourism award or Wayanad wins the ecotourism award.

$$(A \cdot B) \vee C$$

$$(T \cdot F) \vee T$$

$$F \vee T$$

$$\therefore F$$



Activity 5

Using the letters D M K and P abbreviate the simple statements, 'Delhi Dare Devils wins the IPL', 'Mumbai Indians wins the IPL', 'Kerala wins the Ranji Trophy', 'Punjab wins Ranji Trophy'.

- If D and K are True, M & P are False. Find the truth value of the given statements.

Either Delhi Dare Devils wins the IPL or Mumbai Indians wins IPL.



Conditional Statement and Material Implication

1. If we lose the Olympic game, then I will eat my hat.
2. If all humans are mortal and Socrates is a human, then Socrates is mortal.
3. If Sukumar is a bachelor, then Sukumar is unmarried.
4. If the piece of blue litmus paper is placed in acid, then the piece of blue litmus paper will turn red.

Where two statements are combined by placing the word 'if' before the first and inserting the word 'then' between them, the resulting compound statement is a conditional (also called a hypothetical, an implication or an implicative statement).

The consequent of (4) does not follow from its antecedent either by logic alone or by the definition of its terms, the connection must be discovered through experiment. The implication stated here is causal.

The consequent of (1) does not follow from its antecedent either by logic or by definition nor is there any causal law involved. Most causal laws, those discovered in physics and chemistry, for example, describe what happens in the world regardless of peoples' hopes or desires. The conditionals in the example have the following implication.

Every conditional statement means to deny that its antecedent is true and its consequent false. But this may not be its complete meaning. A conditional such as (2) also asserts a logical connection between its antecedent and consequent. Statement (3) asserts a definitional connection, (4) a causal connection and (1) a decisional connection. But no matter what type of implication is asserted by a conditional statement, part of its meaning is the negation of the conjunction of its antecedent with the negation of its consequent.

Any conditional statement 'if p then q ' is known to be false in case the connection $p \cdot \sim q$ is known to be true. That is, its antecedent is true and its consequent is false. For a conditional to be true, the indicated conjunction must be false. That is its negation $\sim(p \cdot \sim q)$ must be true. In other words, for any conditional 'if p then q ' to be true $\sim(p \cdot \sim q)$, the negation of the conjunction of its antecedent with the negation of its consequent, must also be true. We may then regard $\sim(p \cdot \sim q)$ as a part of the meaning of 'if p then q '.

There is a special symbol to represent this common partial meaning of 'if... then' phrase. It is ' \supset ' (called a 'horseshoe') by taking $p \supset q$ as an abbreviation of $\sim(p \cdot \sim q)$. The exact significance of the ' \supset ' symbol can be indicated by means of a truth table.

p	q	$\sim q$	$p \cdot \sim q$	$\sim(p \cdot \sim q)$	$p \supset q$
T	T	F	F	T	T
T	F	T	T	F	F
F	T	F	F	T	T
F	F	T	F	T	T

Implication

Look at the following example. 'If prices go on rising, we may migrate to some other country' is an implicative proposition. The cause 'if the prices go on rising' (p) is the antecedent and 'we may migrate to some other country' (q) is the consequent. Therefore, $p \supset q$ means if p then q.

p	q	$p \supset q$
T	T	T
T	F	F
F	T	T
F	F	T

It can be seen from this table that the only case when $p \supset q$ is false is when p is true and q is false. The meaning of implication will be clear from the table.

According to the truth table, the horseshoe symbol \supset has some implications.

- The assertion that a false antecedent materially implies a true consequent is true.
- The assertion that a false antecedent materially implies a false consequent is also true.



This apparent strangeness can be solved in part by the following considerations.

- As the number 2 is smaller than the number 4, it is symbolically written as $2 < 4$.
It follows that any number smaller than two is smaller than 4
- The conditional formula if $x < 2$ then $x < 4$ is true for any number x
- If we focus on the numbers 1, 3 and 4 and replace the number with the variable x in the preceding conditional formula, if $x < 2$, $x < 4$ is true for any number $x < \text{whatsoever}$.
- If $1 < 2$ then $1 < 4$
- Both antecedent and consequent are true and of course the conditional is true

p	q	$p \supset q$
T	T	T

- If $3 < 2$ then $3 < 4$.
The antecedent is false and the consequent is true, and the conditional is again true
- If $4 < 2$ then $4 < 4$
Both antecedent and consequent are false but the conditional remains true

p	q	$p \supset q$
F	T	T

- If $4 < 2$ then $4 < 4$
Both antecedent and consequent are false but the conditional remains true

p	q	$p \supset q$
F	F	T

The above three cases correspond to the first, third, and fourth rows of the table defining the horseshoe symbol \supset . It is interesting to note that a conditional proposition should be true when both antecedent and consequent are true. If the antecedent is false and the consequent is true, both the antecedent and the consequent are false. There is no number that is smaller than 2 but not smaller than 4. That is there is no conditional statement with true antecedent and false consequent.

p	q	$p \supset q$
T	F	T

Let us check 

Symbolise the following compound statement 'Argentina wins its first game' as A, 'Brazil wins its first game' as B, 'Chile wins its first game' as C.

If A is true, B and C are False, find out the truth value of the following statement.

"If Argentina win its first game then either Brazil or Chile wins its first game."

Negation

The Negation of a statement in English is often formed by the insertion of 'not' in the original statement.

The symbol " \sim " (curl/tilde) is used to form the negation of a statement. Where 'M' symbolises the statement "All humans are mortal", $\sim M$ symbolises "All humans are not mortal".

The 'curl' performs an operation as it reverses truth value on a single unit. Therefore it is a truth functional operator. The negation of a true statement is false and negation of a false statement is true.

This fact can be presented very simply and clearly by means of a truth table:

p	$\sim p$
T	F
F	T

When we negate a negative proposition, we have the original proposition to assert ' $\sim \sim p$ ' is same as to assert 'p'

Alternatively one can express the negation of statement in English by prefixing the phrase 'it is false that' or 'it is not the case that'.

Some books use the symbol '-' for negation.

- $\sim M$ = Not all humans are mortal
- = Some humans are not mortal
- = It is false that all humans are mortal
- = It is not the case that all humans are mortal

Let us check 

Abbreviate the following statement by using letters P and O.

The price of LPG is not increased and the opposition cancelled the strike.

If P is True and O is False, find out their truth value.

Material Equivalence

Material Equivalence is a truth functional connective. It asserts that the statements it connects have the same truth value. Material equivalent is defined as two statements are materially equivalent when they are both true or false. The symbol for material equivalence is the 'three-tier' sign or 'triple bar' ' \equiv '.

This logical relation is only occasionally used. One may say, "I go to the championship game if and only if I can acquire a ticket". This statement is symbolised as $C \equiv T$.

Since the two statements C and T are materially equivalent, imply one another, we may infer from their material equivalence that T is True if C is True and also that T is True only if C is True and viceversa. Any two false statements also materially imply one another.



Here is the truth table for material equivalence

p	q	$p \equiv q$
T	T	T
T	F	F
F	T	F
F	F	T

Logic Gate

A logic gate is an idealized or physical device implementing a Boolean function. It performs a logical operation on one or more logical inputs, and produces a single logical output. A gate is a digital circuit which either allows a signal to pass through it or stops it. It is commonly known as a logic gate because it allows the signal to pass through it only if certain logical conditions are satisfied. Signals in a digital logic circuit take on the values of 0 or 1. Logic gates are devices which compute functions of these binary signals. Whereas in elementary algebra expressions denote mainly numbers. In Boolean algebra they denote the truth values *false* and *true*. These values are represented with the bits (or binary digits) being 0 and 1. They do not behave like the integers 0 and 1, for which $1 + 1 = 2$.

The following table shows some of the representation of logic gates.

Type	Distinctive shape	Boolean algebra between A & B	Truth table												
<u>AND</u>		$A \cdot B$ or $A \& B$	<table border="1"> <thead> <tr> <th>INPUT</th> <th>OUTPUT</th> </tr> <tr> <th>A B</th> <th>A AND B</th> </tr> </thead> <tbody> <tr> <td>0 0</td> <td>0</td> </tr> <tr> <td>0 1</td> <td>0</td> </tr> <tr> <td>1 0</td> <td>0</td> </tr> <tr> <td>1 1</td> <td>1</td> </tr> </tbody> </table>	INPUT	OUTPUT	A B	A AND B	0 0	0	0 1	0	1 0	0	1 1	1
INPUT	OUTPUT														
A B	A AND B														
0 0	0														
0 1	0														
1 0	0														
1 1	1														
<u>OR</u>		$A + B$	<table border="1"> <thead> <tr> <th>INPUT</th> <th>OUTPUT</th> </tr> <tr> <th>A B</th> <th>A OR B</th> </tr> </thead> <tbody> <tr> <td>0 0</td> <td>0</td> </tr> <tr> <td>0 1</td> <td>1</td> </tr> <tr> <td>1 0</td> <td>1</td> </tr> <tr> <td>1 1</td> <td>1</td> </tr> </tbody> </table>	INPUT	OUTPUT	A B	A OR B	0 0	0	0 1	1	1 0	1	1 1	1
INPUT	OUTPUT														
A B	A OR B														
0 0	0														
0 1	1														
1 0	1														
1 1	1														
<u>NOT</u>		A or $\sim A$	<table border="1"> <thead> <tr> <th>INPUT</th> <th>OUTPUT</th> </tr> <tr> <th>A</th> <th>NOT A</th> </tr> </thead> <tbody> <tr> <td>0</td> <td>1</td> </tr> <tr> <td>1</td> <td>0</td> </tr> </tbody> </table>	INPUT	OUTPUT	A	NOT A	0	1	1	0				
INPUT	OUTPUT														
A	NOT A														
0	1														
1	0														



Summary

In this chapter we have discussed :

- The language of symbolic logic, symbolic notations and translation of sentences into symbols.
- Symbolic logic uses artificial “language” to avoid the difficulties of vagueness and confusion.
- Symbolic logic is by far the simplest kind of logic—it is a great time-saver in argumentation. Additionally, it helps prevent logical confusion when dealing with complex arguments.
- The modern development of symbolic logic began with George Boole in the 19th century.
- Symbolic logic can be thought of as a simple and flexible shorthand.



I can

- identify uses of symbolic logic.
- convert propositions into symbolic form.
- construct truth table and find out the truth value of propositions.



Let us assess

1. Find out the truth value of the following P is T ,Q is F and R is T
 - a) $(p \vee q) \vee q$
 - b) $\sim p (p \cdot v)$
 - c) $(p \vee q) \sim r$
2. Distinguish the difference between constant and variable.

3. Change the following proposition into symbolic form and state its truth and falsity using truth table.
 - a) If the barometer is not falling, then there would not be a storm
 - b) Rose is blossoming and fragrance is coming out.
 - c) Students are either hostlers or day scholars.
 - d) Neither Ford or Toyota makes economy cars.
4. Give a brief history of symbolic logic.
5. What are the various uses of symbols in logic? Explain.
6. Explain various types of symbols used in symbolic logic.
7. Point out the differences between disjunction and alternation.
8. Explain Truth Table Method as a decision procedure.
9. What is the main characteristic of constant symbol? Explain with the help of examples.
10. Prepare a seminar paper substantiating the advantages of symbolic logic.

10

THE LOGIC OF RESEARCH

KEY CONCEPTS

- Meaning and definition of research
- Salient features of research
- Qualities of good research
- Stages of research



Introduction

This chapter discusses the meaning, scope and features of research. It also focuses on the various steps in research. They are Selection of the problem, Objectives of the study, Formation of hypotheses, Data collection, Analysis and interpretation, Proving of hypothesis, Findings and suggestions.

Meaning and definition of Research

Listen to the discussion of students on the day-to-day issues.

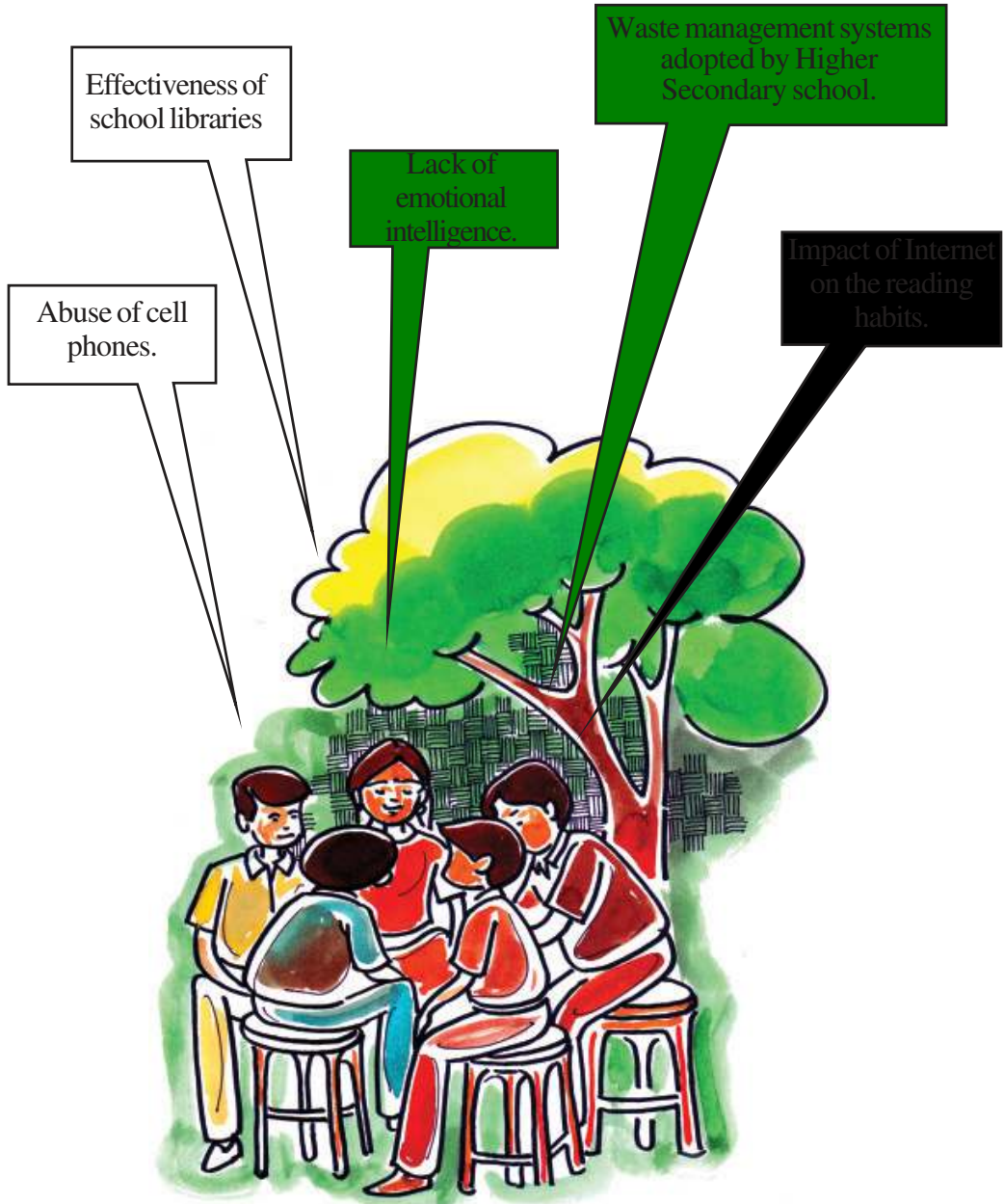



Activity 1

List similar problems you face in daily life

- 1.
- 2.
- 3.
- 4.
- 5.

These are some of the problems we face and strive to find out solutions.

The most important issue identified was '*Impact of Internet on the reading habit of higher secondary school students*'.



Once the problem is identified the natural step is to find out the cause of the issue in order to solve it. It is certain that there are problems in every field, such as science, society, politics, the media, economics etc.

Human beings are interested to acquire information from different sources about the cause of the problems. They always ask questions and try to find out answer for that. They acquire knowledge through enquiries, analysis and interpretations. Today man acquires knowledge through a systematic method, which is generally known as **research**. Moreover, variability is basic feature of human society. Everything in this world is unique. People differ in their attitudes, opinion, capabilities and so on. This poses problems for systematic inquiry to answer specific questions about a phenomenon.

The term Research comes from the French word '**Recherché**'.

This means '**to go about seeking**'.

Commonly research refers to a search for knowledge. It is a systematic method of finding solution for a problem.

It is also a systematic search for the right information on a specific topic. In fact research is an art of intense investigation. Research is an academic activity and as such the term should be used in a technical sense.



Definitions

The Oxford Advanced Learners Dictionary of Current English (8th Ed-2012) explains research as “a careful investigation or enquiry specially through search for new facts in any branch of knowledge”.



Activity 2

Find out the definitions of the word research from various dictionaries and other sources.



(Clifford Woody, Professor of Education

Director of the Bureau of Educational Reference and Research)

According to Clifford Woody research comprises defining and redefining problems, formulating hypothesis or suggested solutions; collecting, organising and evaluating data; making deductions and reaching conclusions; and at last carefully testing the conclusions to determine whether they fit the formulating hypothesis.



Objectives of Research

The purpose of research is to discover answers to questions through the application of scientific procedures. The main aim of research is to find out the truth which has not been discovered yet. Each research study has its own specific purpose. However, research objectives fall into the following broad groupings:

1. To gain familiarity with a phenomenon or to achieve new insights into it. Such study is also called as exploratory research study.
2. To portray accurately the characteristics of a particular individual, situation or a group. Such studies are known as descriptive research studies.
3. To determine the frequency of which something occurs or with which it is associated. Such studies are known as diagnostic research studies.
4. To test a hypothesis of a causal relationship between variables. Such studies are known as Hypothesis-testing research studies.

Salient features of research

- Research is directed towards the solution of a problem.
- It emphasises the development of generalisation.
- It is based on the observable experience on concrete evidence.
- It involves gathering new data from primary source.
- It requires expertise
- Research tries to find out answer for unsolved questions.
- Research formulates theories, principles and predictions.
- It demands accurate description.
- It involves carefully designed procedures and vigorous analysis.
- It is objective and logical.
- Research is a patient and unhurried activity.
- Research must be carefully recorded and reported.
- It requires courage.



Research is done to

- solve a problem.
- understand the facts.
- fulfil the objectives of the study.
- develop a method.

There are four fold scientific activities in Sanskrit to find out the truth

- *Nirupana* [determination]
- *Anveshana* [searching]
- *Anusandan* [researching]
- *Vicharana* [reasoning]

Qualities of a good research

1. **Systematic**:-A good research must always be systematic. It should proceed in a specified manner with the well defined rules.
2. **Logical**:-Research must be guided by logical rules of reasoning. Both deduction and induction must be followed to arrive at generalisation.
3. **Empirical**: - A good research must be empirical, that means research should always be supported by material facts or data.
4. **Replicable**:-The results of the research should be verifiable by repeating of the study.
5. **Critical**: - The research approach should have a critical mind.
6. **Relevance**: A good research must be relevant.



Qualities of a good researcher

A good researcher should have

- ✓ *proficiency in the field of research*
- ✓ *desire for knowledge and truth*
- ✓ *alertness*
- ✓ *power to understand*
- ✓ *education*
- ✓ *persistent curiosity*
- ✓ *positive mind*
- ✓ *reflective ability*
- ✓ *predictive power*

Action research

Action research is a research initiated to solve an immediate problem. It is a reflective process of progressive problem solving. It is led by individuals working in teams or as part of a 'community practice' to improve the way they address issues and solve problems.



Stages of Research

Let us examine how the problem '*The impact of Internet on the reading habit of higher secondary school students.*' is solved.

Let us check



Discuss in groups the possible measures of solving the above problem.

.....

There are certain steps involved in research. They are:

- Selection of the problem
- Defining the objectives of the study
- Formation of hypothesis
- Data collection
- Analysis and interpretation
- Proving of hypotheses
- Findings and suggestions



1. Selection of the Problem

The first step of research is to establish a firm research focus. Researcher should form questions about the problem to be studied and determine a purpose for the study. In the case of government organisation the area of research is suggested by administrators or policy makers. The students of research get the help of a guide/teacher in schools, colleges, universities and research institutions to identify the areas of study. They should discuss the problem with their friends or experts in the field. Researcher should go through journals, news papers, dissertations, research reports etc to discover unanswered questions.

You have discussed with your teacher and friends and selected "the impact of Internet on the reading habit of Higher Secondary school students" as a major problem to be solved. Thus you have been going through the first step of research.

Logic and Reasoning

Sources of a research problem



- Experience
- Literature
- Past research
- Discussion with experts
- Folk knowledge

Qualities of a good research problem



- Researchable
- New
- Significant
- Feasible
 - Competency
 - Enthusiasm
 - Finance
 - Time
 - Administrative considerations

While selecting a problem the following points should also be considered



- ✓ The subject of the research should not be too wide and uncontrollable in nature.
- ✓ Topic should not be too narrow
- ✓ Problem selected should match with academic background, research talent, knowledge and expectance of the researcher
- ✓ The limitations such as time and availability of money should also be considered while selecting the problem.



Activity 4

Find out any popular folk belief or myth in your place.

.....

.....

.....

Review of related literature



In order to undertake a research activity, sufficient background information on the research topic is essential. Review of related literature is a pre-request for gaining background knowledge on the research topic. It gives brief review of previous studies on the problem. The researcher attempts to look back into what has been done in this area through surveys seminar papers, journals, articles, books, news papers etc.

2. Objectives of the study

Researcher should clearly state the objectives of the study. The goals to be achieved in this study should be listed here. The overall research process is confined to these objectives. It will help him to produce meaningful output.



Let us check



Write the objectives for the topic Impact of Internet on the reading habit of higher secondary school students.”

- To analyse whether there are any differences on the reading habit of HSS students due to the of Internet.
- To suggest some measures for improving the reading habits of students and healthy use of Internet resources and services
-
-
-

3. Formulation of hypotheses

The next step in research is to state the working hypotheses. You have already studied in chapter 8. It is a tentative solution/assumption made in order to draw out and test its logical or practical consequences. It is the crucial point of research. In most types of research, the development of working hypothesis plays an important role. Hypothesis should be very specific and limited to the objectives of the research. The role of the

Logic and Reasoning

hypothesis is to guide the researcher by delimiting the area of research and to keep the researcher on the right track. It sharpens thought and focuses attention on the more important aspects of the problem. It also indicates the type of data required and the type of methods of data analysis to be used.



Activity 5

Frame hypothesis for the topic “Impact of Internet on the reading habit of higher secondary school students.

- Main purpose of the use of Internet is communication rather than academic purpose.
- The use of Internet reduces reading habit of HSS students.
-
-
-

4. Data collection

All kinds of research works require data. Data can be collected in different ways. The collection of data in the initial stage is statistical investigation. There are two types of data - primary and secondary.

Sources of forming hypotheses

- Cultural values of the society
- Past research
- Local Knowledge
- Personal experience
- Discussions



Primary data

Primary data are those which are collected for the first time. In other words primary data are original in character. Primary data is directly related to the phenomena under investigation.

E.g. Census, survey, diaries, questionnaire etc.

Secondary data

Secondary data are those which have already been collected, tabulated and presented in some form by someone else for some other purpose. The secondary data are in the form of finished products. Secondary data are indirect and reports based on primary data.

Method of Data collection



- Observation
 - Interview
 - Using telephone
 - Questionnaire
 - Schedules
- (i) **Observation:** This method implies the collection of information by way of investigator's own observation. The information obtained relates to what is currently happening. It is not complicated either by the past behaviour or future intentions or attitudes of respondents. This method is expensive. The information provided by this method is also very limited. As such this method is not suitable in inquiries where large samples are required.
- (ii) **Through personal interview:** The investigator seeks answers to a set of pre-conceived questions through personal interviews. This method of collecting data is usually carried out in a structured way. The output depends upon the ability of the interviewer to a large extent.
- (iii) **Through telephonic interviews:** This method of collecting information involves contacting the respondents over the telephone. This is not a very widely used method. But it plays an important role in industrial surveys in developed nations, particularly, when the survey has to be accomplished in a very limited time.
- (iv) **By mailing of questionnaires:** The researcher and the respondents do come in contact with each other if this method of survey is adopted. Questionnaires are mailed to the respondents with a request to return after completing them. It is the most widely used method in various economic and business surveys. Before applying this method, usually a pilot study for testing the questionnaire is conducted. It will reveal the weaknesses, if any, of the questionnaire. Questionnaire to be used must be prepared very carefully so that it may prove to be effective in collecting relevant information.
- (v) **Through schedules:** Under this method enumerators are appointed and given training. They are provided with schedules containing relevant questions. These enumerators go to respondents with the schedule.

Let us check



Prepare a questionnaire that helps to verify any two hypothesises of the problem under investigation.

(Note : a sample questionnaire is given below.)

Questionnaire



General information

- Name :
- Gender : Male/Female
- Subject/Class :

1. Do you use the following Internet tool/service?

(a) Email (b) WWW (c) Social network (d) Educational website

2. Specify the frequency of the use of Internet

Tool/service	Daily	Weekly	Monthly	Occasionally
Email				
WWW				
Social network				
Educational website				

3. Specify the purpose of the use of Internet.

(a) Communication (b) Assignments (c) To find out friends (d) Films/ pictures

4. Do you agree to the statement that Internet usage will reduce reading habit?

(a) Agree (b) Partially agree (c) Disagree

5. Does the use of Internet help you in your academic works?

Yes No

6. Is training essential for students to create awareness about better use of the Internet?

Yes No

5. Analysis and interpretation of data

The data collected need to be analysed. The analysis of data requires a number of closely related operations. It includes establishment of categories, the application of these categories to raw data through coding and tabulation, and then drawing statistical inferences.

The data should be put in to manageable groups and tables for further analysis. Thus, researcher should classify the raw data into some purposeful and usable categories. *Coding* operation is usually done at this stage. Here the categories of data are transformed into symbols that may be tabulated and counted. *Editing* is the procedure that improves the quality of the data for coding. With coding the stage is ready for tabulation. *Tabulation* is a part of the technical procedure wherein the classified data are put in the form of tables. The mechanical devices can be made use of at this juncture. A great deal of data, especially in large inquiries, is tabulated by computers.



The following table is the tabulation of 100 questionnaires done by a group of students on the hypothesis of the issue “Impact of Internet on the reading habit of Higher Secondary school students”

Purpose	Male		Female		Total	
	No	%	No	%	No	%
Communication	20	40	15	30	35	35
Assignment	10	20	20	40	30	30
Films/pictures	12	24	5	10	17	17
To find out friends	8	16	10	20	18	18
Total	50	100%	50	100%	100	100%

Let us check



Analyse responses in the questionnaire in the form of a table as given above.

6. Proving hypotheses

At the final stage the verified hypothesis is tested to show that it is the only adequate explanation of the given phenomenon. Hypotheses formulated in the beginning of the study can be tested with known statistical methods. After identifying the validity of hypotheses, the tentative solution to the problem will become a scientific truth or fact.

The above table shows that the main purpose of the use of Internet is for communication rather than academic purpose.

Let us check



Construct a table tabulating the questionnaire regarding the other hypothesis ‘the use of Internet reduces reading habit of HSS students.’

Generalisations and interpretation: If a hypothesis is tested and upheld several times, it may be possible for the researcher to arrive at generalisation, i.e. to build a theory. As a matter of fact, the real value of research lies in its ability to arrive at certain generalisations. If the researcher had no hypothesis to start with, he might try to explain his findings on the basis of some theory. It is known as interpretation. The process of interpretation may bring in new questions which in turn may lead to further researches. Interpretation refers to the task of drawing inferences from the collected facts after an analytical and/or experimental study. In fact, it is a search for broader meaning of the research findings.



7. Findings and suggestions

A conclusion reached after an examination or investigation is called the finding. It is the result of the process involved in the entire steps of research. The other stages are the stepping stones to arrive at findings. In this step we reach at a conclusion of the problem under investigation. The finding reveals that the hypothesis is the cause of the phenomena. Our finding concerning the problem ‘the impact of Internet on the reading habits of higher secondary school students’ is that the use of Internet adversely affects the reading habits of students. A genuine research work should contain specific suggestion for solving the



problem and improving conditions in the light of the finding. After finding the cause of the problems under investigation the researcher can suggest solutions for the problems.

- The above study shows that male students often use Internet more for communication and amusements.
- Female students use Internet more for study purpose.

Suggestions

- As a researcher list out suggestions to improve the reading habits of students even while using Internet.
-
-
-

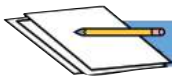

Summary

Research is a systematic method of finding solution for a problem. The salient features of research are: it is directed towards the solution to a problem, it emphasises the development of generalisation, it is based on the observable experience on concrete evidence and it involves gathering data from primary source. There are certain qualities for a good research. The stages of scientific investigation / research are: selection of the problem, objectives of the study, formation of hypotheses, data collection, analysis and interpretation, proving of hypotheses and final findings and suggestions to solve the problem.



I can

- o Identify various steps in a research.
- o solve problem in our daily life through research method.
- o recognize the qualities and features of research.
- o do research and prepare research papers.



Let us assess

- I. Tick (✓) the correct answer.
- The term research comes from the French word "*recherché*" it means
 - to go about seeking
 - learning
 - knowing
 - to go about willing
 - Which of these is not a method of data collection.
 - Questionnaires
 - Interviews
 - Observation
 - Hypothesis
 - Which of the following is the first step in starting the research process?
 - Survey of related literature
 - Hypothesis of problem
 - Searching for solution
 - Solution to the problem
 - The essential qualities of a Researcher are
 - Positive mind
 - Power to understand
 - Curiosity
 - All the above
 - A research paper is a brief report of research work based on
 - Primary Data
 - Secondary data
 - Both the Primary and Secondary data
 - None of the above
 - Briefly describe the different steps involved in a research process.
 - What do you mean by research?

8. Write short notes on
 - (1) Objectives of research
 - (2) Criteria for a good research
 - (3) Research and scientific method.
9. How do you define a research problem? Give three examples to illustrate your answer.
10. For the research topic 'Abuse of cell phones among school students', write 2 or 3 objectives?
11. Write 3 or 4 hypotheses of the research topic - "Waste management system adopted by school students"



BIBLIOGRAPHY

1. Irving.M.Copi (2010): "Introduction to Logic" (14th Edition), *MacMillan Publication*, NewDelhi.
2. Patrick J Hurley(2012): "A Concise Introduction to Logic (11th Edition), *Wadsworth Cengage Learning Publication*, USA.
3. Graham Priest (2000): "Logic A Very Short Introduction", *Oxford Press Publication*, NewYork.
4. Irving M Copi and Keith Burgess(1996): "Informal Logic" (3rd Edition), *Macmillan Publication*.
5. Irving M Copi(2006): "Essentials of Logic", *Macmillan publication*, *New Delhi*.
6. Lizzy Lewis & Nick Chandley(2012): "Philosophy for Children Through the secondary curriculum", *Continuum International Publishing Group*, New York.
7. John L Taylor(2012): "Think Again: A Philosophical Approach to teaching", *Continuum Publishing group*, New York.
8. Ben Dupre(2007): "50 Philosophy Ideas you really need to know", *Quercus Publishing plc*, London.
9. Naresh Ghai(2008): "Philosophy Thinkers and Thoughts Living issues in Philosophy", *Cyber Tech Publication*, USA.
10. R.S Aggarwal(2008): "A modern approach to Verbal & Non-verbal reasoning", *S Chand & Co. ltd*, Newdelhi.
11. Anjani A Gupta(2008): "All about Reasoning (Verbal)", *Ramesh Publishing House*, *New Delhi*.
12. Earl Hunt(2011): "Human Intelligence", *Cambridge University Press*.

13. Prabhat Javed(2009): "Non – Verbal Reasoning", *BSC Publishing Co.Pvt. Ltd.* New Delhi.
14. C.R. Kothari(2012): "Research methodology: Methods and techniques" (Second Revised Edition) , *New Age International Publication.*
15. Frederick. J. Gravetter(2000): "Research Methods for the behavioral Science, *Wods worth Cengage Learning, USA.*
16. Louis Cohen(2007): "Research methods in Education" (6th Edition-Special Indian Edition) , *Routledge Publication.*
17. Dawson and Catherine(2002): "Practical Research Methods", *UBS Publishers,*
18. Kumar Ranjith(2005): "Research methodology, A step – by – step guide for beginners", (2nd edn.) *Pearson Education.*
19. Ranjendra Kumar (2008): "Research Methodology", *APH Publishing Corporation, New Delhi.*
20. Orustein (2011): "Foundations of Education" (11th Edition), *Wods worth Cengage Learning ,USA.*
21. Premchand Jogi(2009): "History of Educational Philosophy", *Crescent Publishing Corporation.*
22. **Galavotti**, Maria Carla (2000): "Observation and Experiment in the Natural and Social Sciences"-

Boston Studies in the Philosophy and History of Science, *Kluwer Academic Publishers, Netherland.*
23. Judea Pearl, Causality(2009): "Models, Reasoning and inference" (2nd Edition), *Cambridge University Press.*
24. Stephen S Carey(2011): "A beginner’s guide to Scientific method", *Wods worth Cengage Learning, USA.*

Logic and Reasoning

25. Hugh G Gauch Jr(2003): "Scientific Method in Practice", *Cambridge University Press*.
26. Richard D Jarard(2001): "Scientific Methods: An online Book", *Dept. of Geology and Geophysics, University of Utah*.
27. Robert L Park(2010): "Superstations: Belief in the age of Science, *E. Book-n*
28. Ramnath Sharma(2012): "Text Book Of Symbolic Logic", *Surjeet Publications, Delhi*.
29. A.Wolfk(1976): "Text Book of Logic", *Surjeet Publication*.
30. Irvin M Copi and Cal Cohen (1995): "Introduction to Logic", 9th Edition, Macmillan USA.
31. James Edwin Creighton (1919): "An introductory Logic", *MacMillan Company*.
32. William J Kilgore(1968): "An introductory Logic", *MacMillan Company*.
33. L S stebbing(2011): "Modern elementary Logic", *Cambridge University Press*.