

1 Electricity



What is required to switch on radio? When does T.V. get switched off?

With these types of questions, the word 'electricity' gets reflected in your mind. The word 'electricity' is associated in day-today life in this contrary. We see the apparatus like lamps, radio, T.V., fan in which electrical energy is used. Prepare a list of other such apparatus where electric energy is used.

How does a machine or a motor work with electrical energy? How electric lamp (glowsh) illuminates when it is switched on?

What is required? Bulb used in torch, metallic wire (wire which can allow current to pass through it) battery, insulating tape, rubber band etc.....

What to do?

- Get a bulb used in torch and two pieces of conducting wire.
- Connect two pieces of wires with bulb using insulating tape as shown in the figure 1.1.
- As shown in the figure 1.1, connect these two conducting wires with battery (cell) using rubber band.
- Does the lamp glow? (illuminates)? _____
- Remove any one wire from bulb or battery and note the observation.

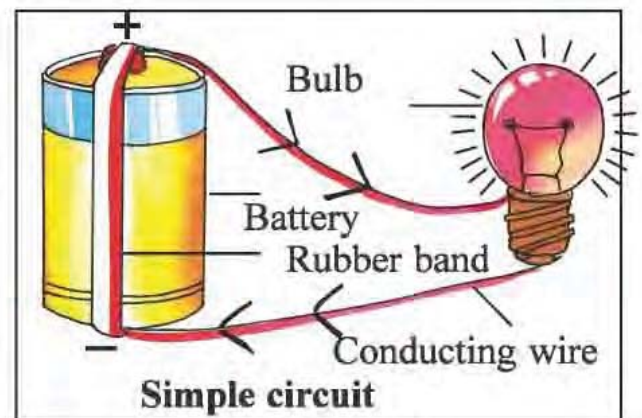

Figure 1.1

1 ♦ Electricity

We can observe that it is necessary to connect both the terminals of battery using conducting wire with both terminals of bulb for the how of envert thus when it is connected, the path to flow current circuit is completed.

The closed path where the current flows is known as circuit.

Now, connect the wire, battery and lamp as shown in the following figure (1.2) and observe whether the bulb glows or not.

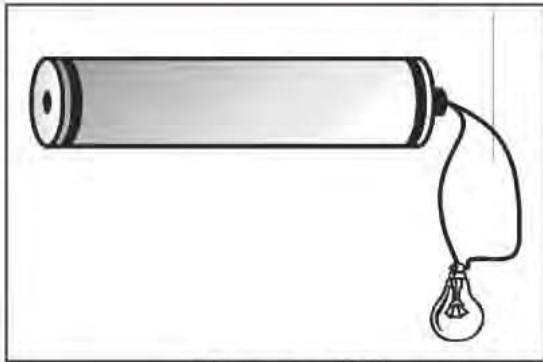

Figure -1.2

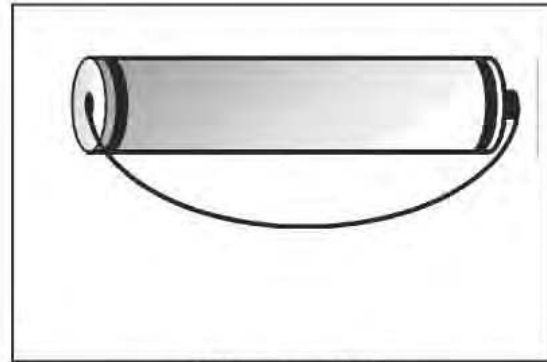

Figure -1.3



Why should one not do like this?

Now, connect the circuit as shown is fig.4 and note observations as per instructions in table.

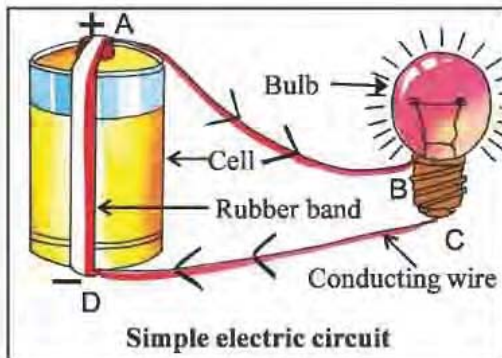

Figure 1.4

Removing end	observation-Bulb glows /does no glow
A	
B	
C	
D	

Thus,

- If both the ends of battery are connected at the different ends of the bulb using conducting wires, such closed path is known as “Closed circuit” and current flows in the closed circuit.
- “If one of the ends of the bulb or battery is disconnected or open, then such circuit is known as “Open circuit”. The current does not flow in open circuit.

1 ♦ Electricity



What is required? Piece of thermocol, two pieces of conducting wire, two drawing pins, safety pins, (Pushpins)

What to do?

- Get a safety pin, pass the drawing pin from ring of it.
- Paste it on the thermocol piece as shown.

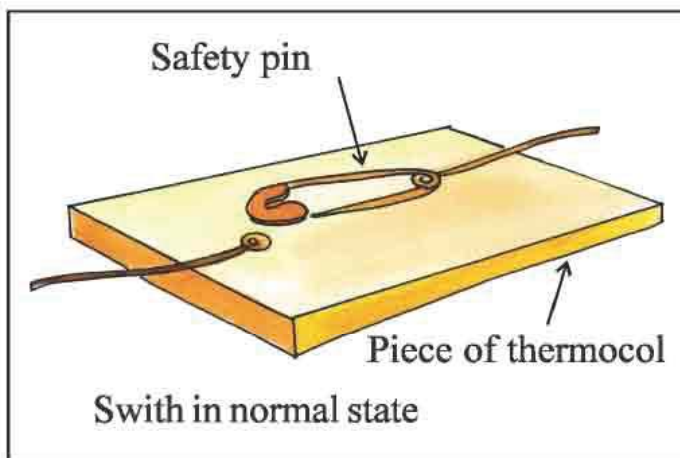

Figure 1.5

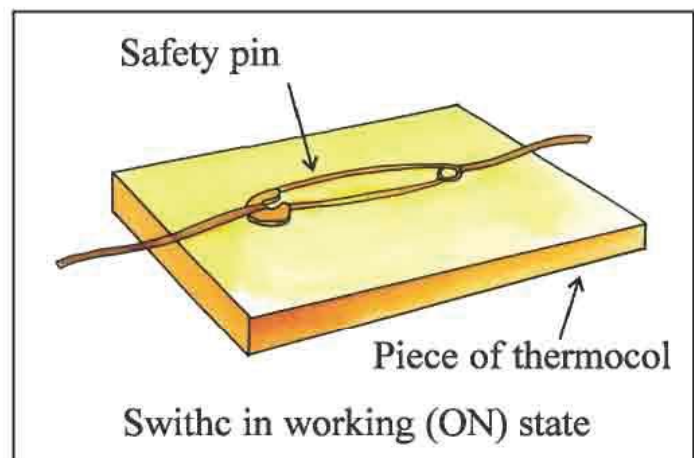

Figure 1.6

- Join the another drawing pin on thermocol board in such a way that the other end of safety pin touches the drawing pin.
- Connect both the conducting wires with drawing pins.
- A switch is ready.

A switch is a device which does not complete the electric circuit in normal (OFF) state and completes the electric circuit in conducting (ON) state.

- **Switch in 'OFF' state** —————> **Open circuit condition**
- **Switch in 'ON' state** —————> **Closed circuit condition.**



Think, whether the electric circuit is completed or not when you switch 'ON' the fan.

1 ♦ Electricity



What is required? a bulb used in torch, a battery, three conducting wires, an insulating tape, a rubber band,

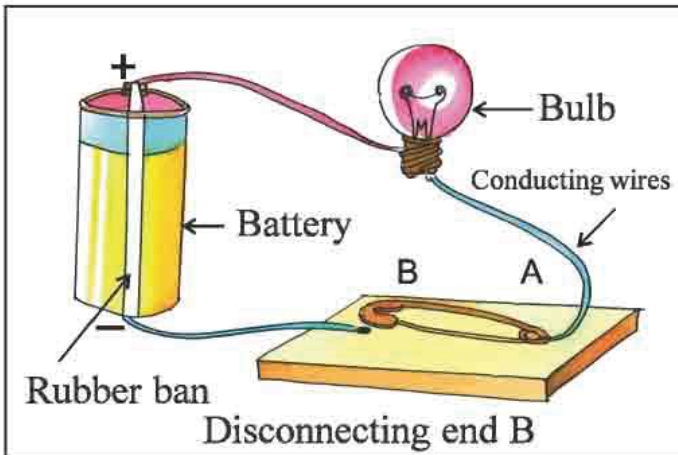

Figure 1.7

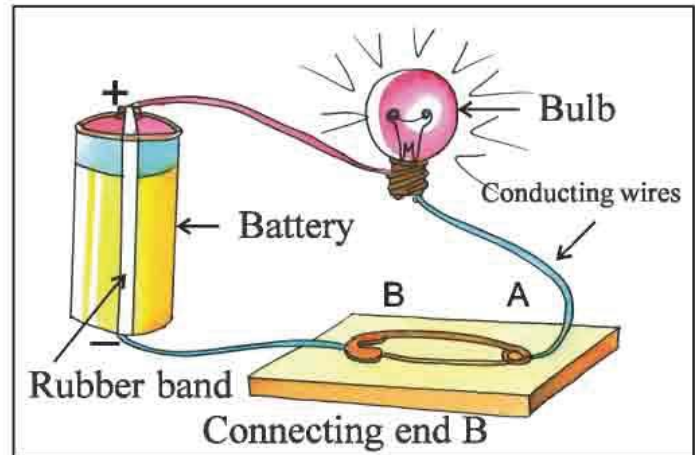

Figure 1.8

What to do?

- Connect one end of lamp with one of the conducting wire of the switch and the other end of the lamp with one end of battery. Connect the other end of battery with the other end of the switch.
- Bring the open end of safety pin in contact of push pin, what happens?

- Remove the end of the safety pin from the contact, what happens?

- From the above two observations, you will be able to answer while switching on switch.

1 ♦ Electricity



Electric conductors and insulators (non-conductors) :

What is required?

a bulb, a cell, an insulating tape; a conducting wires, a wooden plank, a pencil, a key, a refill of pen, a match stick.....

What to do?

- Prepare an electric open circuit as shown in the Figure 1.9
- Connect ends A and B with items shown in the following table.
- Observe whether the bulb glows or not and list them in the table.

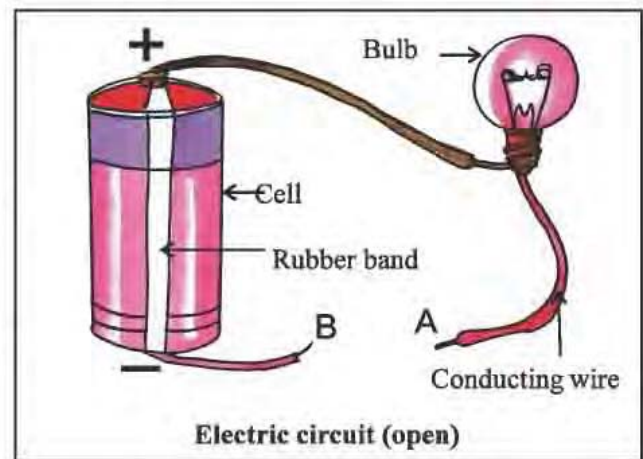

Figure 1.9

Sr.No.	Thing (Other things except these can be taken)	Whether bulb glows? yes or no?
1	Rubber	
2	Wooden planck	
3	Pencil	
4	Key	
5	Refill of pen	
6	Match stick	
7		
8		
9		
10		

1 ♦ Electricity

We can say all the observations of the previous activity :

- Those things when connected to the wires, makes the bulb glow - that means current flows through them. These things are conductor.
- Those items, when connected to the wires, do not make the bulb glow, that means the current does not flow through these items. These things are non conductor items. (Materials).
- The things which allow the current to pass through them it are known as electric conductor.
- The things through which current does not pass are non-conducting materials or (insulators).

Classify the things taken for activity :

1. Conductors. _____
2. Insulators _____



Use of electricity in daily life is abundant. One can not think life without electricity. Discuss the following questions :

- (1) How do the bulbs of bus, rickshaw, bike (Motor bike) glow?

- (2) How does a bulb of the torch glow?

- (3) How does the circuit get completed in a torch? (Get the torch and observe)

- (4) Which item remains on after removal of electric power?

1 ♦ Electricity

(5) Discuss and note what precautions are to be taken while using electric appliances?

**Cautions :**

- Do not connect wires directly in the plug.
- Use insulating tape while connecting two ends of wires.
- Do not touch the electric switch with wet hands (why?)
- Do not try to catch the thread of the kite hanging from electric pole.



Use the earthed wire in household wiring.
The electric appliances having sign as shown in Fig. only should be purchased. The number of stars indicates the level of saving of electricity.

More the stars, more the saving.



Figure 1.10

Fuse :

Fuse is seen in the electric circuit in the house, in addition to switch, bulb, tubelight etc.

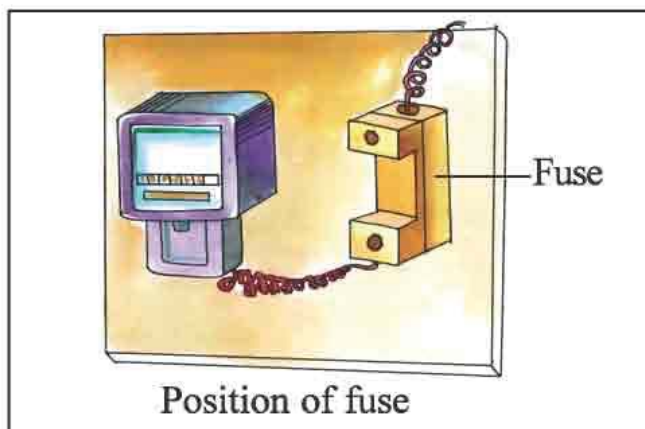

Figure 1.11

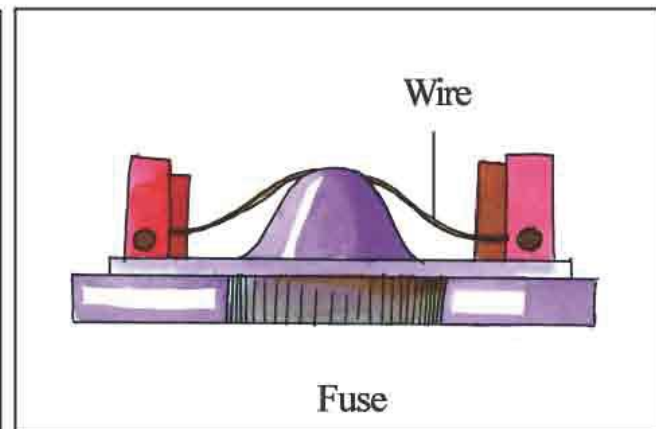

Figure 1.12

1 ♦ Electricity

- In each fuse, a small, thin, special type of conducting wire is used, which can melt easily. When more current passes through it. When amount of current passing through electric circuit increases beyond certain limit, the fuse connected in electric circuit immediately melts and opens the circuit and stops the current flowing in the circuit. Hence, accident can be avoided.

When fuse goes off...

- Put off the main switches.
- Remove the remains of the wire from the fuse carefully it may be hot;
- Remove the melted wire of the fuse.
- Connect new fuse wire.
- Connect the fuse assembly.
- Switch 'ON' the main switch.

Note : Our body is a good conductor of electricity, hence care must be taken while working with electric circuits. Use battery while performing all practicals in your text book.

Caution :



You must have noticed the signs as shown here on electric poles and electric appliances. This sign is an indicator of the fact that if proper care is not taken while using these electric appliances, it can bring fatal injuries or even death can occur, hence never tinker with electric wires or electric sockets.



(1) **M.C.B. :** Are used for the protection from short circuits in electric circuits at home or offices. It has a function like main switch. MCB immediately switches off when short circuits take place.

(2) **Vampire power :** Many times the appliances like T.V. or computers are switched off using remote sets instead of mechanical switches. Instruments like mobiles can be kept with plug connected even after complete charging. In these cases, appliances use the power and it is a waste of electric energy. That is known as vampire power.



Figure 1.13

1 ♦ Electricity



Why does it so happen when there is a trouble in light or fan in one room at home, the lights and fans in the other rooms remain on ?



Let us do the following activity to understand above situation.

What is required?

Four bulbs used in torch conducting wires, insulating tape, two batteries, rubber bands.

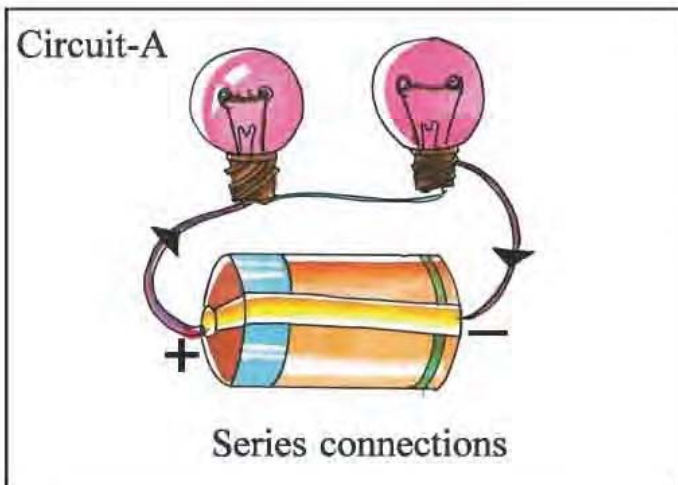

Figure 1.14

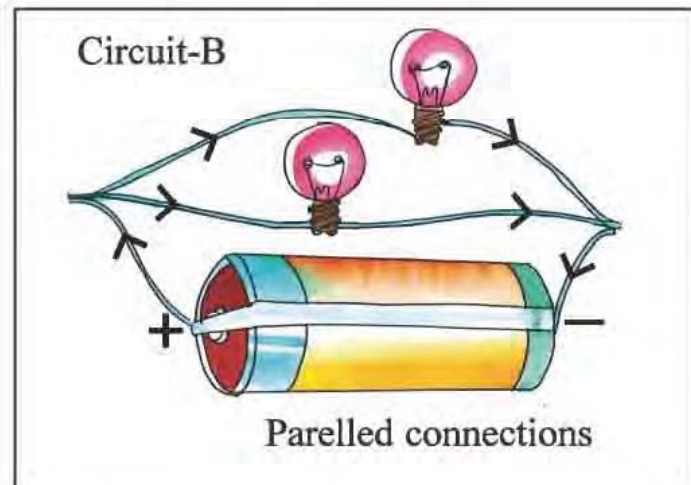

Figure 1.15

What to do?

- Prepare two electric circuits as shown in Fig. 1.14 and Fig. 1.15
- Remove one of the ends of any one bulb connected in circuit A. Write your observations.

1 ♦ Electricity

- Remove any one end of conducting wire connected with a bulb in circuit B and write your observation.
-
-
- What is the conclusion from your observations? Which type of electric connection are used in household electric circuits? Circuit A or Circuit B?
-
-



Electric circuit A is a series connection in which there is a single track only for the flow of currents, which gets open when any one wire is disconnected and the current stops flowing through electric circuit.

Circuit B is a parallel connection. There are more than one paths available to flow through bulb or appliances. They are having parallel connections, in which only those appliances stop working where wires are disconnected because current stops flowing in that path.



1. Prepare the electric circuit shown here in Fig. 1.16
2. Classify electric conductors and non conductors (insulators) Rubber, plastic, iron, aluminum, match stick, chalk stick, cloth piece, copper wire, key.

Electric conductors :

Insulators :

3. Prepare the list of appliances used at your home and school in which electricity is used.
4. What will you take while working with electric circuits?

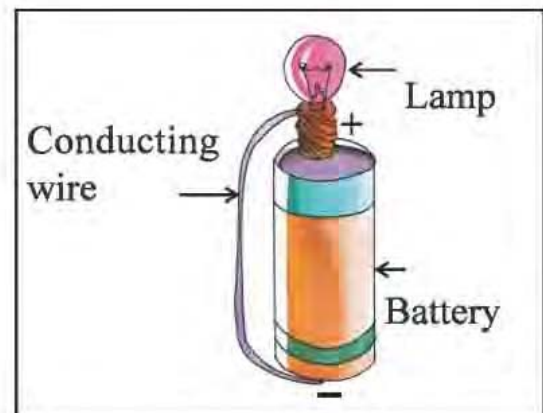

Figure 1.16

2

Lever



Figure 2.1

Write the names of simple machines used in different parts of bicycle on the basis of its figure.

Part used in bicycle / Name of part	Simple machine
Brake	
Wheel	
Nut-bolt	
Paddle.	

Thus, bicycle is prepared using different simple machines. Let us try to know more about lever, one of the types of simple machines.



- Try to push a heavy stone as shown in the figure 2.2 and note your experience here.



Figure 2.2

2 ♦ Lever

Now try to push the same heavy stone using big rod as shown in the figure 2.3.

Note here your experiences.

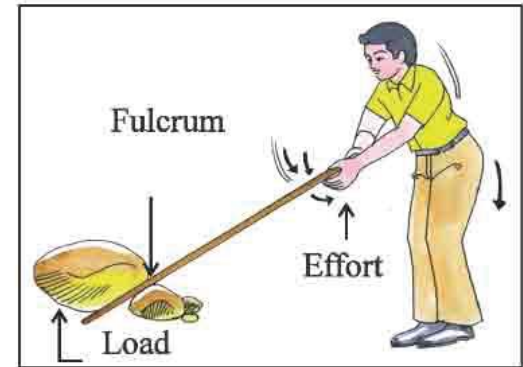

Figure 2.3

- “A strong rod which can move with force around point of support is known as lever”.
- Lever is a simple machine. Lever can be used to get work done easily, quickly and with less amount of efforts.

Parts of lever :

- **Fulcrum** : The point with respect to which rod can move freely is called fulcrum.
- **Load** : The object which can be pushed or lifted using one of the ends of lever is known as load.
- **Effort** : The force applied at one of the ends of the lever to do work is known as effort.
- **Distance of efforts** : The distance from effort to fulcrum is known as distance of effort.
- **Distance of load** : Distance from fulcrum to the load is known as distance of load.
- **Load end** : The end of the lever with which work is done is known as load end.
- **Effort End** : The end of the lever where force of effort is applied is known as effort end.

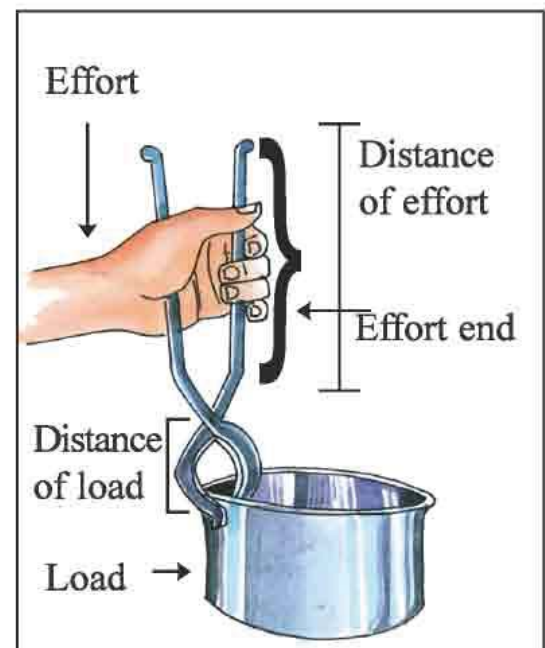

Figure 2.4

2 ♦ Lever

With this knowledge of parts of lever, let us try to understand how lever can be used to get work done easily and quickly.

**What is required?**

Approximately two ft. long and one cm thick wooden stick, masses of 20 gm, 50 gm, 100 gm and 200 gm, iron hooks, a wooden stand.

What to do?

- Scale the wooden stick 'o' at the centre and write the numbers, 10,20,30at equal distances, on both the sides of the wooden stick as shown in fig. 2.5.
- Place the iron hooks at the marks 10, 20, 30 as shown in fig. 2.6.
- Fit this wooden stick, which can have free movement , keep in mind that wooden stick is balanced.
- Hang a 100 gm mass at one of the ends of wooden stick at marked 10 and observe what happened (as in fig. 2.7).

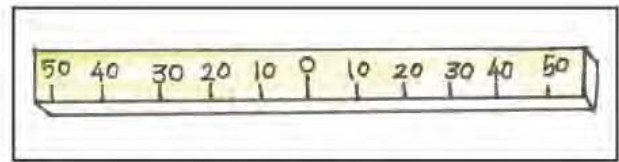

Figure 2.5

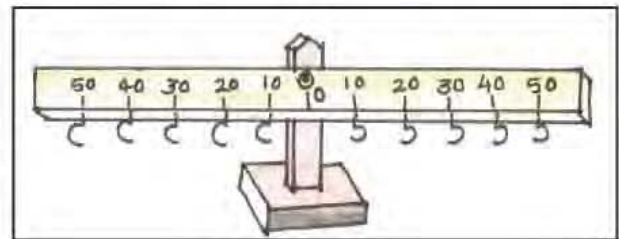

Figure 2.6

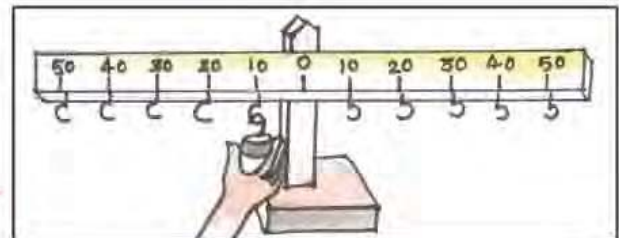

Figure 2.7

- Hang another 100 gm mass at the other side marked '10' and observe what happens. Note your observation.
- Now remove 100 gm other side and replace 50 gm mass at a distance marked 20. What happens ? Note your observation.

2 ♦ Lever

How has this happened?

If 100 gm mass is considered as a load and '10' unit distance as load distance from fulcrum at '0' then $(100 \times 10) = 1000$ gm. cm the product of load and load distance (if load distance is measured in cm.) Thus, again when at the other end, 100 gm mass is considered as an effort and '10' unit distance as distance of effort from fulcrum at '0' then the product of effort and distance of effort will be $100 \times 10 = 1000$ gm.cm.

Thus, the product of load & load distance is equal to the product of effort and distance of effort [load x load distance = effort x distance of effort]

Thus, in similar, way 150 gm mass at unit mark '10' is replaced by 50 gm mass at unit mark '20' we get load (100 gm) x load distance (10 cm)

= effort (50 gm) x distance of effort (20 cm)

= 1000 gm cm. This causes the horizontal balance of the wooden stick.

Principle of lever :

Load x load distance = effort x distance of effort

Fill in the details in the following table using the apparatus of lever :

Obs No.	Load (gm) L	Distance of load (cm) DL	Product of load and load distance L x DL (gm/cm)	Effort E (gm)	Distance of effort (cm) DE	Product of effort & distance of effort EX DE (gm cm)
1	200	10	-----	100	-----	-----
2	400	10	-----	-----	80	-----
3	400	-----	8000	200	-----	-----

It is clear from this activity that higher distance of effort will be more useful with less effort to lift or push the load easily and quickly. Thus, work can be done easily, quickly and with less efforts using principles of lever.

2 ♦ Lever

**What is required?**

Lemon juicer, scissors, nut cracker, fork, utensil plucker, long handled broom plier-etc.

What to do?

- Complete the following table by observing the above list of objects.

object	Mark '✓' what is at the centre?		
	Fulcrum	Load	Effort

- (1) Prepare a list of objects having fulcrum at the centre

“The type of lever in which fulcrum is between the centre of load and effort is known as type-1 lever.

- (2) Prepare a list of objects having load at the centre.

“The type of lever in which load is between the fulcrum and effort is known as type-2 lever.

2 ♦ Lever

List the objects other than given in the previous picture where principles of different types of lever are used

We use many objects, in which the principles of lever are used in daily life. Have you noticed or observed such objects ? List them in the following table.

Sr. No.	Name of object	What is at centre?	Type of lever	Use



(1) Name of the object : _____

(2) Show load, effort and fulcrum in the fig. 2.8.

(3) What is the type of lever?

(4) Which part of lever is at the centre in the object shown in figure?

(5) What is the type of lever (fig. 2.9) ?



Figure 2.8

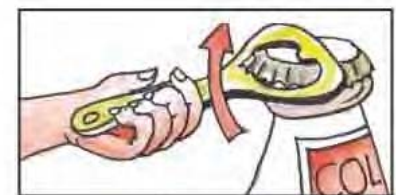

Figure 2.9

2 ♦ Lever

(6) Which part of the lever is at the centre in this object?

(7) What is the type of lever fig. 2.10?



Figure -2.10

Give the explanations of the following words with reference to **lever** :

effort, load, fulcrum

(8) Give scientific reasons :

1. The length of the hands of scissors used to cut the metal sheets are kept longer.

2. The length of the hands of scissors used by tailor is less than the length of blades is more.

3

Separation of Substances

We come across many substances around us. How are these substances made? Here below, the list of some substances is given in the table. Will you be able to say from which they are made of?

No	Name of the substance	Made of
1	Tea	
2	Lemonade	
3	Soil	
4	Sea water	

You can see that the each of the above substances is made of two or more constituents. Such substance is called mixture.

The constituents with which a mixture is made may be of any state either solid, liquid or gaseous. Names of some mixtures are given below in a table. Place its constituents according to the their form in the proper column.

No	Name of the mixture	From which constituents it is made?		
		Solid	Liquid	Gaseous
1	Mixture of rice and pulses			
2	Lemons juice			
3	Air			
4	Sugar solution			
5	Soda-water			
6	Fog			
7	Fermented dough for Dhokalas			

3 ♦ Separation of Substances

On the basis of the state of the components, there are seven different types of mixtures :

1. Mixture of solid substances.
2. Mixture of liquid substances.
3. Mixture of gaseous substances.
4. Mixture of solid and liquid substances.
5. Mixture of gaseous and liquid substances.
6. Mixture of gaseous and solid substances.
7. Mixture of solid, liquid and gaseous substances.



Having discussed with your friends, find out some examples of each of this.

Sometimes a necessity arises to separate the components of a mixture such as,

- (1) To remove non-required components. For example, to remove bran (peel off the skin) from roasted salty peanuts.
- (2) To get rid of harmful components. For example, to remove small pieces of stones from grains.
- (3) To know the proportion of the components. For example, to know the proportion of sand, clay, silt and organic materials in the soil.
- (4) To separate the components as per requirement. For example, to separate wheat and rice from the mixture.
- (5) To obtain pure sample for an experiment. For example, to obtain distilled water.

Method to separate components of a mixture is called 'Separation'. For separation there are different methods. On the basis of the properties of the constituents of the mixture a proper method for separation is used. Come on. Let us know about such methods through activities.

3 ♦ Separation of Substances

**Picking**

What is required? Grains mixed with small pieces of stones, plate.

What to do?

- Take grains mixed with small pieces of stones in a plate.
- Picking the small pieces of stones from the grains and remove.

Generally two solid substances which do not mix with each other are separated from a mixture by picking with hand. This method is known as 'Picking'.

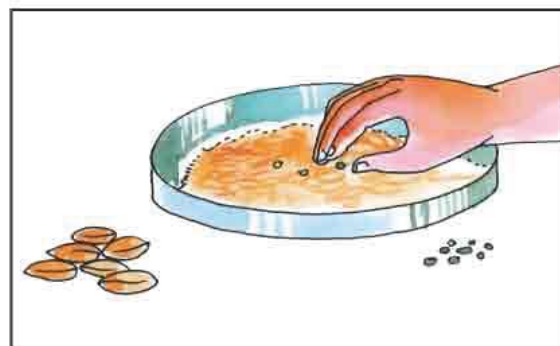

Figure 3.1

(1) Why are small pieces of stones separated from grains?

(2) Do you use 'Picking' method anywhere else?

**Sieving**

What is required? Wheat flour, sieve, plate.

What to do?

- Keeping a sieve on a plate, take a small quantity of flour in it.
- Shaking the sieve slowly, sieve the flour.
- After sometime, touching the flour left in the sieve with impurities and the flour collected in the plate, make your observation.



Figure 3.2

If the solid substances are not of the same size and they do not mix with each other. The process by which they can be separated from the mixture with an appliance having a wire mesh fixed tightly in a frame like a sieve is called 'Sieving'.

3 ♦ Separation of Substances



(1) Why do we separate the substance left in the sieve from the flour?

(2) Have you seen the use of this method anywhere else?



3. Winnowing

What is required? Roasted salty peanuts.

What to do?

- Take salty peanuts in the hands and crush them with both the hands.
- Transfer them from one hand to the other hand and meanwhile blow some air slowly on them.



Figure 3.3

What did you see?

In a mixture, the substances which are light in weight can be separated with blowing some wind on them. Such a method is known as 'Winnowing'.

From a mixture, to separate the components with winnowing method, it is necessary that there should be difference between their densities.

(1) Why do we remove the husk of salty peanuts?

(2) Have you seen the use of this method anywhere else?

3 ♦ Separation of Substances

**Decantation**

What is required? Dirty water, two transparent glasses.

What to do?

- Take dirty water in a transparent glasses
- Keep this glass on a plane surface like table.
- Let the glass be on the table for about thirty to forty minutes and then observe it.

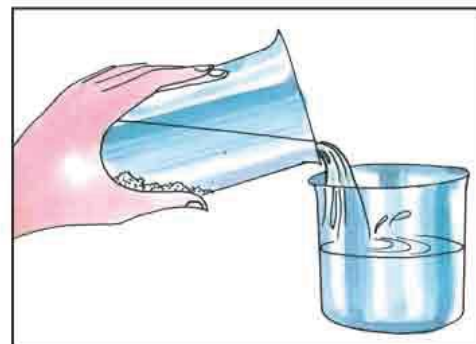

Figure 3.4

What did you see?

Now, slowly take the upper water from the glass in the other glass. Observe the water obtained in the other glass.

The method to separate the substances which are insoluble in liquid as well as have different densities method to separate called 'Decantation'.



(1) Have you seen the use of decantation method anywhere else?

(2) Why are dust and dirt separated here from water?



From the mixture of liquids having different densities, separating funnel is used in laboratory to separate each constituent.

What is required? Mixture of kerosene and water, a separating funnel and two beakers.

What to do?

- Fill the separating funnel with the mixture of kerosene and water.
- Keep it steady for some time.

3 ♦ Separation of Substances

What did you see?

- Now keep a beaker just below the separating funnel and open the cock of the separating funnel.
- Once the water from the separator funnel comes out completely, close the cock of the separating funnel.
- Now keep the other beaker just below the separating funnel and open the cock again.
- Observe the liquids collected in both the beakers.
- This process of separation is called separation method. It is a type of 'Decantation method'.



5. Filtering

What is required? Decanted water obtained from the previous method, a piece of cotton cloth, two beakers, a string.

What to do?

- As shown in the figure 3.6, tie a piece of cotton cloth on the mouth of a beaker with a string.
- Now, slowly pour the water obtained from decantation on the cloth tied to the beaker.
- Observe carefully the water collected in the second beaker and substances.
- Solid substances which do not dissolve in liquid are separated by the method with network mater is called 'Filtering'.



Figure 3.6

3 ♦ Separation of Substances



(1) Why are the insoluble solid impurities removed from water?

(2) Have you seen the use of this method anywhere else?



Figure 3.7

In modern times, for purification of water, modern purifiers are used. In which different kinds of harmful material as well as virus wastes are removed and water is made drinkable.



6. Magnet Method

What is required? Saw dust, Iron filings, paper, magnet

What to do?

- Mix saw dust and Iron filings on a paper.
- Move a magnet through the mixture.

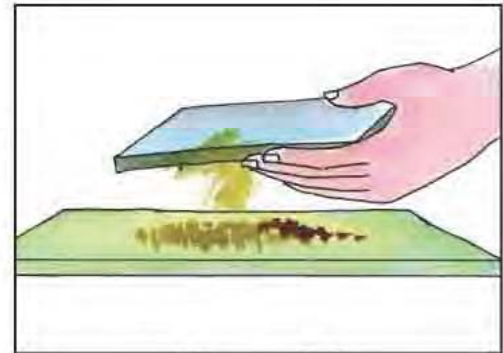

Figure 3.8

What did you see?

The method of separating iron from the mixture is called 'Magnet Method'.

(1) Which components from the mixture can be separated by this method? Why?

(2) Have you seen the use of this method anywhere else?

3 ♦ Separation of Substances



7. Sublimation

What is required?

Camphor, common salt, evaporating bowl, glass funnel, cotton, tripod, wire gauze, spirit lamp, match box.

What to do?

- Take mixture of camphor and common salt in an evaporating dish.
- Close the nozzle of the glass funnel with cotton.
- Keeping a wire gauze on the tripod, place an evaporating dish.
- As shown in the figure: 3.9, place the glass funnel upside down over the evaporating dish.
- Light the spirit lamp and put it under the tripod.
- Go on observing the evaporating dish bowl and the funnel for some time.
- Once the white smoke starts rising up in the nozzle of the funnel, wait for a moment and then extinguish the spirit lamp.
- Allow the glass funnel to cool down for some time, then observe the white substance deposited on the inner side of the funnel.

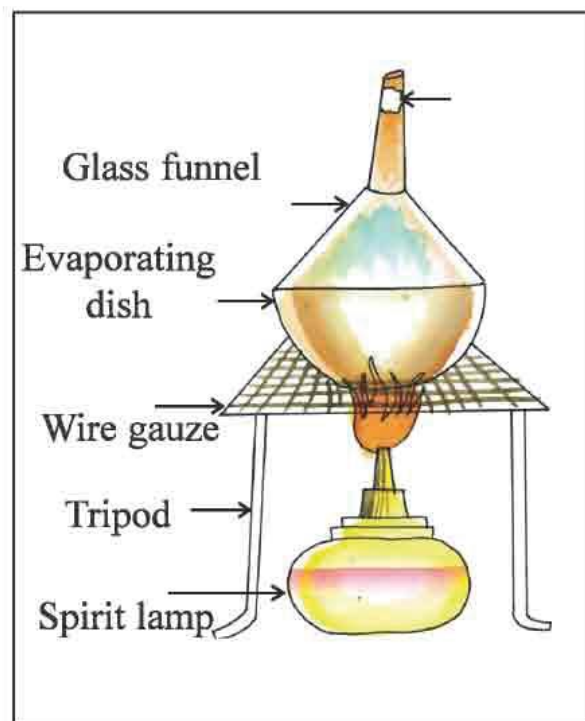

Figure 3.9

When some substances in a solid state are heated then they directly change into gaseous state and if cooled the gaseous state directly turned into solid state. This type of substances are called sublimating stances.

eg. Camphor, Napthalene-pill, iodine, dry ice.

To separate sublimating substances from a mixture the special method used is called 'Sublimation'.

3 ♦ Separation of Substances

**Evaporation**

What is required? A beaker, Water, Common salt, spoons, a saucer.

What to do?

- Take some water in a beaker.
- Add some common salt and prepared solution it salt by stirring with spoon
- From this solution, take some amount of solution in a saucer.
- Keep this saucer outside in the afternoon sun shine for two to three hours.
- After that, observe the solution in the saucer.

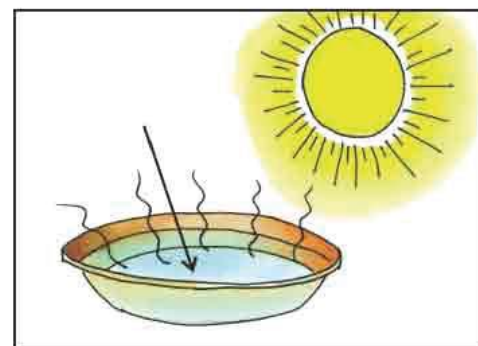

Figure 3.10

What did you see?

With the heat of the sun, water from the solution changes to water-vapour. Thus water and salt are separated from the salt-solution. This process is called 'Evaporation'.

**Where is this method used ?****9. Distillation**

What is required? Flask, cork, thermometer, tripod, wire-gauze, condenser, receiver flask, spirit lamp, match box, water.

What to do?

- Arrange the apparatus as shown in the figure: 3.11.
- Light the spirit lamp. When the mercury of the thermometer shows the temperature 100°C keep an empty beaker near the opening end of the condenser.

3 ♦ Separation of Substances

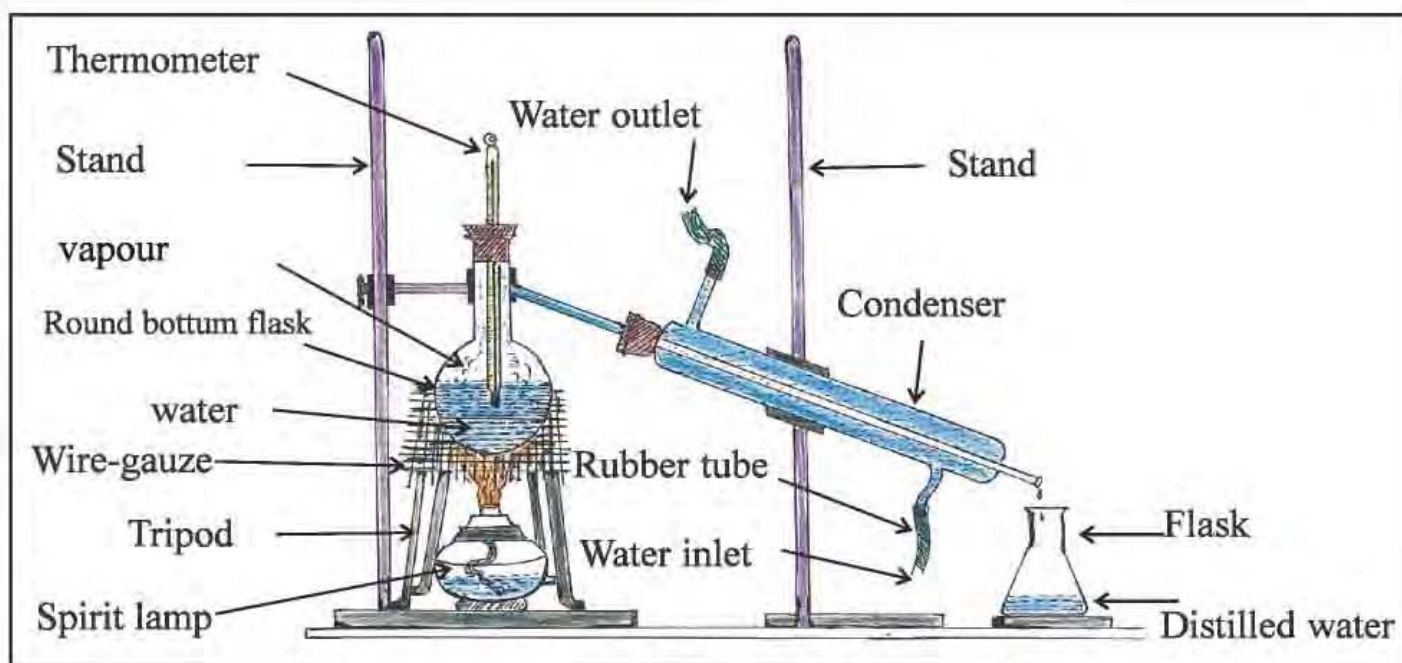

Figure 3.11

What did you see?

The components are separated from the mixture of liquids having different boiling points and are obtained in the pure form by the process which is called 'Distillation'.

The water collected in the receiver flask by this method is 'Distilled water'.



- (1) Where do we use distilled water?
- (2) Is distilled water proper for drinking? Why?



Crude oil is distilled in the 'Fractional distillation towers' and at different temperatures petrol, naphtha, kerosene, diesel, tar, wax, etc. substances are separated.



Where else is distillation method used in practice?

3 ♦ Separation of Substances

Q.1 Below is the list of some mixtures given. To separate the components from the mixtures, which method will you apply? Mention the method, giving the reason for it :

- (1) Mixture of Sulphur and iron filings
- (2) Mixture of oil and water
- (3) Mixture of peanuts and grams
- (4) Mixture of common salt and Naphthalene balls
- (5) Solution of sugar

Q.2 Explain the differences :

- (1) Filtering and Decantation
- (2) Sieving and Picking
- (3) Evaporation and Distillation

Q.3 Thinking the forms of the state of the components of the mixture, mention the mixtures are of the what type :

- (1) Fermented syrup for Jalebi
- (2) Soil
- (3) Air
- (4) Lemon juice
- (5) Solution of glucose

Q.4 Make a list of the different methods for isolation which you generally use in every daily life.



4

Measurements



• Mass :

What is required? Two cups, water

What to do?

- Take two cups of same size.
- Fill one of the glasses up to half level and the other completely with water.
- Put these glasses (with the help of a friend) on your palm, simultaneously.
 - (1) Which cup appears heavy?

(2) Why?

- The glass completely filled with water contains more quantity (mass) of water.
- The amount of quality of material possessed by the object is known as mass. It is expressed as 'm'
- The mass of the same object increases with increase in quantity of mass.



Fill one cup with water and the other with sand completely and put them on your palm simultaneously.

(1) Which glass appears heavier?

(2) Why?

- The mass of different types of substances having same volume is different.

4 ♦ Measurements



- Repeat the same activity by taking two different type of substances. Which substance has higher mass? Note it.

So far as the quantity of the substances present in does not change the mass of the substances does not change. Mass of substances remains same every where.

Different types of physical balances and weight boxes are used for the measurements of mass.

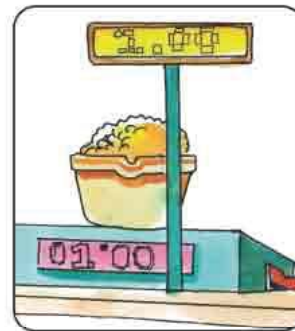

Fig. 4.1 Different types of balance



Where do we use these types of balances (physical balances)?

For the measurements of mass of chemicals with specified volume in laboratory, gold, silver, or diamond, the balances shown in fig. 4.2 are used.

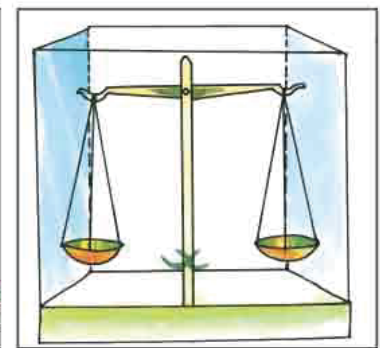
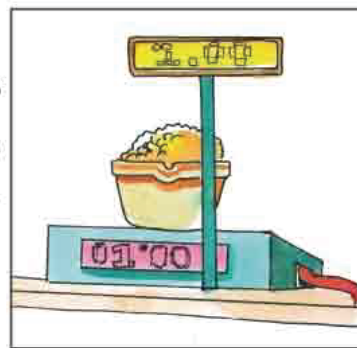

Fig. 4.2



Why are these types of balances kept in glass box?

4 ♦ Measurements



• Measurement of mass :



Figure 4.3 (Different weights)

What is required? Balance, weights, sand, wheat

What to do?

- Take a balance as shown in fig. 4.4.
- Get different weights from weight box.
- Weigh 500 gm same with this balance.

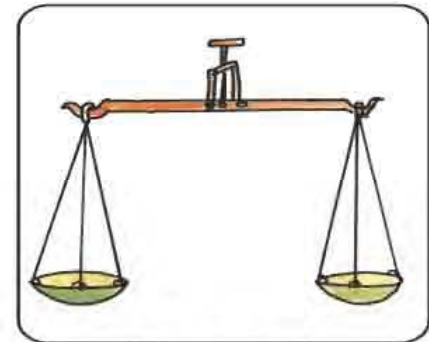

Figure 4.4



What have you done for that?

- Pour wheat in one of the part of the balance. Find what is the mass of wheat.

Mass of Wheat = _____



What have you done for that?

We measure the mass of wheat or sand in gram or kilogram. Gram (gm) and kilogram (kg) are the units of measure of mass.

Kilogram is a standard measure of mass. It is expressed as kg.

4 ♦ Measurements



What is required : Balance, weights

What to do?

- Take one balance. Put 1 kg weight in one of the pans.
- Put the different weights in grams in the other pan and balance the balance.
- What is the weight of gram measurement equivalent to 1 kg in other pan?

- 1 Kilogram (kg) = 1000 gram (gm)

We use the unit like ton for purchase of quantities in more proportions.

- 1 Ton = 1000 (kg) kilogram.

The units of mass used in prace line are as follows.



1 share = Approximately = 500 gram (g)

1 man = 20 kilogram (kg)

1 quintal = 100 kilogram (kg)

1 Qunital = 1000 kilogram (kg)

- **Weight**



Fig. 4.5 Different weighing units



What is gravitational force ?

The gravitational force acting on any substance at any place is known as weight of the substance at that place. It is denoted by 'W'. Spring balance is used to measure weight.

4 ♦ Measurements

The weight of any object can be calculated using the following formula :

$$w = mg \text{ [where } m = \text{mass of the substances}$$

$$g = \text{gravitational acceleration)}$$

$$g = 9.8 \text{ m/sec}^2 \text{ and the unit of } g \text{ is m /sec}^2]$$



What is the unit (measure) of mass?

What will be the unit of weight?

The unit of weight 'N' is known as Newton in memory of Newton)



• **Measures of weight**

- Mass of Jay is 30 kg, find his weight

$$w = mg$$

$$= 30 \times 9.8$$

$$= 294 \text{ N or } 294 \text{ kgm / sec}^2$$



Similarly, find the weight of your five different friends.

No.	Name of friend	Mass (m) (kg)	Weight W (N)

4 ♦ Measurements



Measure the weight using spring balance.

No	Object	Weight W (N)
1	stone	
2	Compass box	
3	Book	
4		
5		
6		
7		

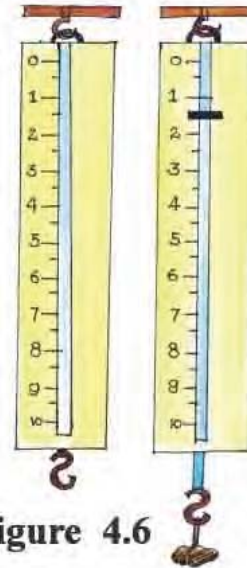

Figure 4.6

Gravitational force on the moon is one sixth that acts on the objects on the earth : hence weigh of substances ing 60 N on the earth will be 10N on the moon.



Earth is bulged at equator and The valuse gravitational force is zero at the centre of the earth. The value of gravitational force increases as we move away from the centre of the earth, while substances on the polar region is comparatively near to the centre of the earth, its weight is more there.



Write the differences : mass and weight

Mass	Weight
_____	_____
_____	_____
_____	_____
_____	_____

4 ♦ Measurements

**Measurement of volume :**

What is required? two bowls, grains of peas and mung.

What to do?

- Get two equal bowls.
- Fill the grains of peas in one and grains of mung in the other
- Which grains are required more in number to fill bowl?

why? _____



Which type of ball, from volley ball or cricket ball, occupies more space?



What a compass box or your text book of science and technology, occupies more space?

The space occupied by a substances is known as volume, Volume of a substances is what is expressed as 'V'



What is required? one jug, one cup, water.

What to do?

- Take the jug and the cup and fill both with water. _____
- In which is there more of water? _____

“The capacity of any vassel to accommodate more amount of the liquid is called or holdering capacity or beaming ”

4 ♦ Measurements

• Units of (measure) of volume :

- The standard unit of volume is cubic meter or meter³.
- The smaller unit of volume is cubic centimeter (C.C.) or cm³

$$1 \text{ cubic meter} = \text{metre}^3$$

$$= 1 \text{ meter} \times 1 \text{ meter} \times 1 \text{ meter}$$

$$= 100 \text{ cm} \times 100 \text{ cm} \times 100 \text{ cm}$$

$$= 1000000 \text{ cubic (centimeter) or } .\text{cm}^3 = 10^6 \text{ cm}^3.$$

- Litre and milliliter are other units of measurement of volume of, their symbols are L and ml respectively.



What is required? Different measuring units, water

What to do?

- Fill the litter measuring unit with water using milliliter measuring units.
- How much of water is required to fill 1 liter? _____

$$1 \text{ Litter} = 1000 \text{ milliliter}$$

$$1 \text{ litter} = 1000 \text{ cubic (cm)} = 1000 \text{ cm}^3. \therefore 1 \text{ milliliter} = 1 \text{ cubic cm (1 cm}^3)$$

- Volume of liquid can be measured by two methods.

- (1) With the help of measuring units
- (2) With the help of scaled measuring flasks.

With the help of measuring units

Where do we use the measuring units shown in figure 4.7?



Fig. 4.7 (cone shaped measuring units)

4 ♦ Measurements

Where do we use measuring units shown in fig. 4.8 ?

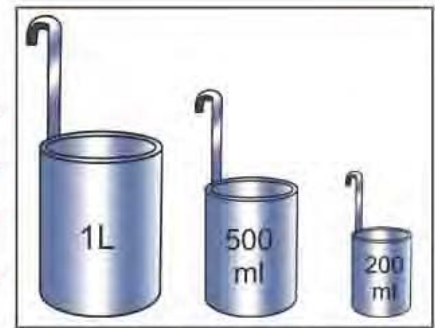

Figure 4.8



What is required? a bucket, a jug, a pot, a glass, a water bottle and water

What to do?

- How much water is filled in each of the above vassles? Find with the help of measuring units.

No.	Vassel	Volume of the water (litre)
1.	Bucket	
2.	Jug	
3.	Cup	
4.	Earthen pot	
5.	Water bottle	
6.		
7.		

Where are the apparatus shown in fig. 4.9 used?

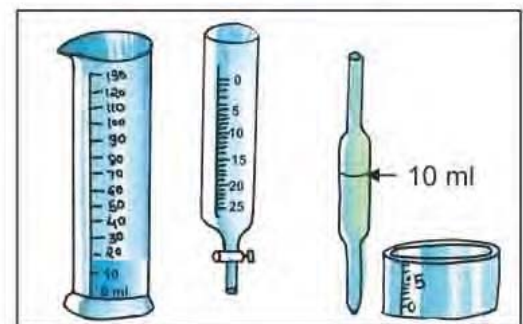

Flask, burette pipet scaled units (Fig. 4.9)

4 ♦ Measurements

**Measurement of volume of liquid pipette.**

What is required? Pipette, water

What to do?

- Take a pipette, observe it.
- How much volume of liquid a pipette can measure?

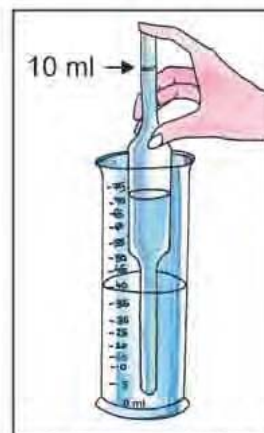

Figure 4.10

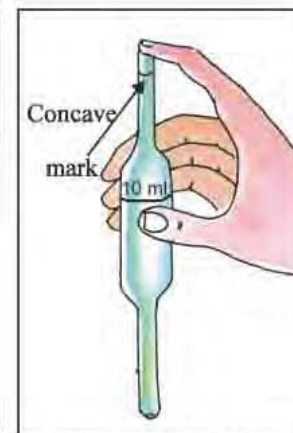

Figure 4.11

- As shown in fig. 4.10 dip the pointed tip of the pipette in the water.
- Suck the water through the open end of the pipette.
- Fill the pipette completely with water. Put your finger or thumb immediately on the upper open end of the pipette after removal from your mouth, so that the water will not flow out. (as in fig. 4.11)
- Put the water level mark on pipet in front of your eyes (horizontally)
- Removing the finger slowly from the upper end of the pipette the water will flow out. Remove the pipette, so that the concave surface part of the water shown comes to the mark in the figure.

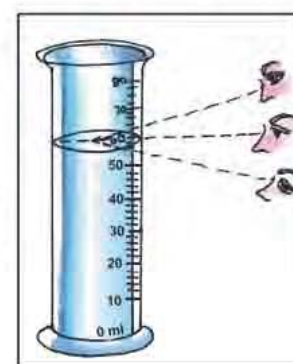

Figure 4.12

**Volume Measurement by measuring cylinder :**

What is required? a pipette, a measuring cylinder, water

What to do?

- Take a pipette. Take 10 ml water with pipette and fill the measuring cylinder.
- Place flask so that it is at its level.

V = _____

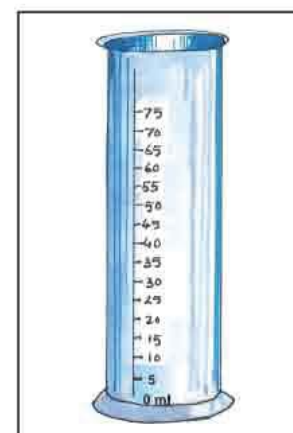

Figure 4.13

4 ♦ Measurements

- Put the measuring flask little slant as shown in the and read the level $V =$ _____
- When can accurate measurement be done ?

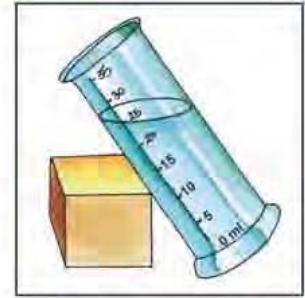

Figure 4.14



Observe the figure carefully. From which angle can correct measurement be observed ?

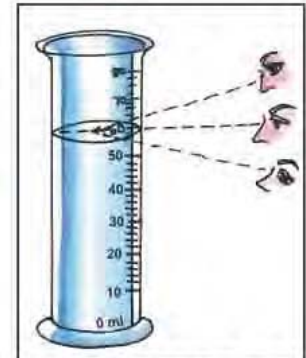

Figure 4.15

- Count the number of marks between '0' to '10' ml measuring flask.
- How many divisions of 10 ml are there on it ?



The volume of device like refrigerator is given in liters. Why?



Least count measure

What is required? Measuring cylinder, water

What to do?

- First of all take a measuring cylinder.
- Find the volume occupied between two consecutive big marks on the flask.
- Count the number of small divisions marked between the difference between two large consecutive marks.

Least count measure : The capacity to measure the volume of the minimum liquid at any vessel, is called least count measure of the vessel.

Thus, in general

Least count measure = $\frac{\text{Measure between two successive big marks}}{\text{Number of small divisions between two successive big}}$

4 ♦ Measurements



- Determine the least count measure of the cylindrical flask you are having with you.
- Least count measure = _____



What is required? a measuring cylinder, coloured water, a bowl.

What to do?

- Take measuring cylindrical
- Fill coloured water in the bowl
- Find the volume of coloured water in ml. and note down.
- Measure of volume of water = _____
- **Measurement of volume of solids.**

(1) Measurement of volume of regularly shaped (symmetric) solid.

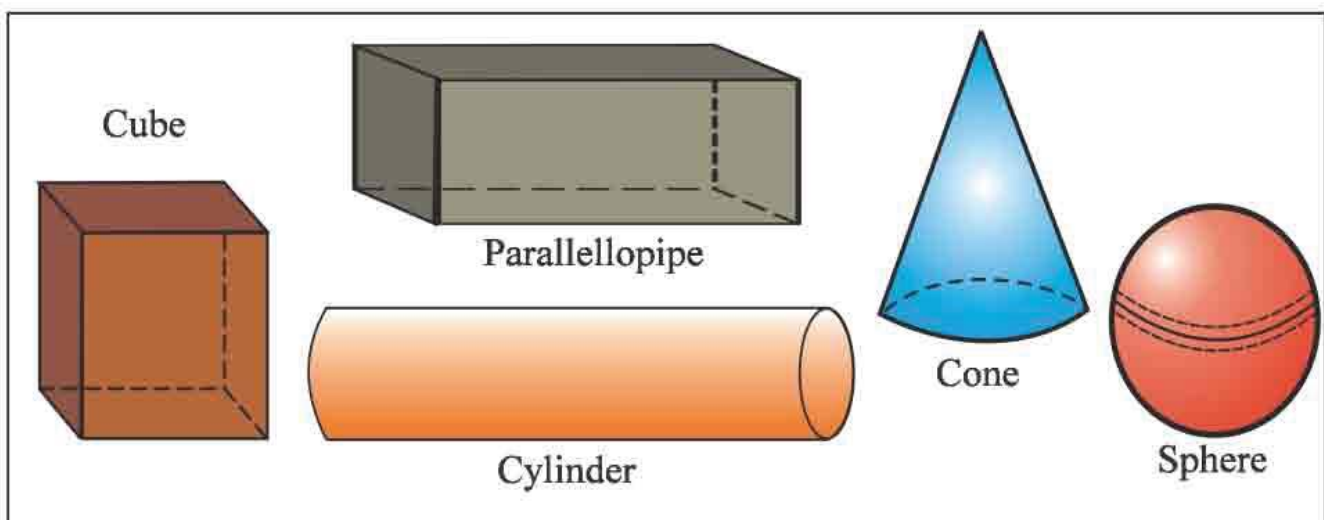

Figure 4.16

- Volume of well - regular shaped solids can be found using formula.

4 ♦ Measurements

- Volume measurements of cube and parallalo piped solids can be obtained using following formuls :

$$\begin{aligned}\text{Volume of cube} &= \text{Legnth} \times \text{length} \times \text{length} \\ &= l \times l \times l \\ &= l^3\end{aligned}$$

$$\begin{aligned}\text{Volume of parallalopipe} &= \\ \text{Length} \times \text{breadth} \times \text{height} &= l \times b \times h \\ &= l bh\end{aligned}$$



Collect the cubic and parallalopied substances you get near by you. What will be its volums, calculate with the help of given formula Measure their volume using the formula and tabulate them in table

No.	Name of object	Length(l)(cm)	Breadth(b)(cm)	Height (h) (cm)	Volume V (cm ³)
1	book				
2					
3					
4					
5					
6					
7					

- Measurement of volume of solid substances. For solid substances of irregular shape.
 - Measurement of volume of solid which are sinkin g in water as well as remain insoluble.
 - With the help of measuring cylindrer sbstances.
 - With the help of displacement cylindrer.



1. With the help of neasuring flask.

What is required? Measuring cylinder, thin strong thread, irregularly shaped stone, coloured water.

What to do?

- Get the irregular shaped stone
- Tie it with strong thin thread.

4 ♦ Measurements

- Take measuring flask. Fill coloured water in it.
- Note its level $V_1 =$ _____ ml of the surface with proper alignment.
- Immerse the stone tied with thread in the measuring flask slowly.
- Note down, what happens.

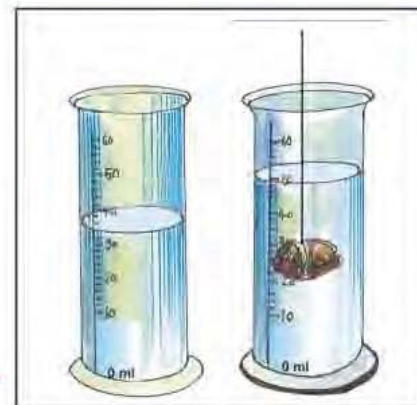

Figure 4.1

- Stone displaces coloured water equal to its own volume. Hence, its water level rises
- Note this reading volume v_2 ml
- $V_2 =$ _____ ml
- $V_2 - V_1 =$ _____ ml
- Thus, volume of stone $V_2 - V_1 =$ _____ ml



Note : This method can also be used for regular shaped in soluble solid substances.



How do we measure the volume of irregular shaped solid substances this method?



With the help of displacement vassel

What is required? a displacement, a vessel, a container, a measuring cylinder, stone, thread, coloured water.

What to do?

- Take irregular shaped stone.
- Tie it with thin strong thread.
- Take the displacement vassel. Fill it with coloured water, closing its nozle with finger.
- Remove the finger and allow the excesswater to flow out of the nozle.
- Adjust the measuring cylinder near end of the nozle.

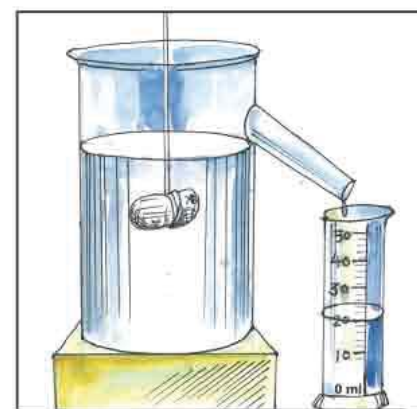

Figure 4.18

4 ♦ Measurements

Now,

- Immerse the stone tied with thread completely in water. What happens due to this?

- How much coloured water is collected in measuring cylinder ?
- Volume of the water = _____ ml
- Volume of the water collected in flask represents the volume of the stone.
- Therefore volume of stone = _____ cm^3 = ml



Measure the volume of regularly shaped solids using measuring flask (cylinder)

The volume of solid substances is measured in cubic meters or cubic centimeter, while, volume of the liquid substances is measured in liters.

- **Density**



What is required? Key, lid of pen (Plastic) bucket, water

What to do?

- Fill the bucket with water
- Immerse the key and the lid of pen in the water

What happens ?

Why?

4 ♦ Measurements



If an iron piece dropped in water, it sinks in to it; while big ship prepared from iron does not sink, why ?

Here we can not say is lighter than water. Thus, on the basis of characteristic of floating only can not be said that only substances is heavy or light.

Densities are measured to compare their lightness or heaviness.

“The ratio of mass and volume of a substances is known as its density.”

Density :

- What is the unit of mass ? _____
- What is the unit of volume? _____

Hence unit of density = $\frac{\text{Unit of mass}}{\text{Unit of volume}} = \frac{\text{gm}}{\text{cm}^3}$ or $\frac{\text{kg}}{\text{m}^3}$



Collect, different substances like an eraser, a key, a stone, a dice, water, oil, honey, a bar magnet, glass balls, a brick. Find mass of object and volume of each object and find its density.

No	Name of the substances	mass (g) m	V volume (cm ³)	Density $\rho = \frac{m}{V}$ (gm/cm ³)
1	Key			
2	Eraser			
3	Stone			
4	Dice			
5	Water			
6	Oil			
7	Bricks			
8	Honey			
9	barmagnet			
10	Glass ball (marble)			

4 ♦ Measurements

- Which substances have density lesser than that of water?

- Will all the substances float on the water or sink in it?

- The substances with less density than that of water will float on the water.
- Which are the substances having density higher than that of water.

- Will all these substances float or sink in water.

- The substances having density higher than that of water will sink in water.

Name of substances**Density (gm/cm³)**

Ice	0.92
Water (pure)	1.00
Sea water	1.03
Iron	7.8

Name of the substances**Density (gm/cm³)**

Lead	11.8
Mercury	13.6
Pure gold	19.3



Q.1 Write the correct answer for the question listed below from given options :

- (1) Which instrument is used to measure the mass of a substance ?
(a) Spring balance (b) Burette (c) Balance (d) Measuring cylinder
- (2) Which apparatus is used to measure volume of liquid?
(a) Physical balance (b) measuring cylinder
(c) Spring balance (d) Weights
- (3) Which units is used for the measurement of weight?
(a) Kilogram (b) gram (c) Newton (d) milliliter

4 ♦ Measurements

Q.2 Match the following :

A	B
1 Kilogram	1000 millilitre
1 litre	1 cubic centimetre
1 millilitre	1000000 cubic centimetre
1 cubic meter	1000 gram

Q.3 Note, how much water is stored in water tank sited in your village.

Q.4 Note, how much of water is stored in water tank at your home.

Q.5 Note how many litre of water is stored in a pot at your home

Q.6 When you go for shopping in the bazar, in which units is the measuerment made ?

Q.7 Where will be correct measurement useful to you?



5

Mirrors and Reflections

When we observe objects, animals, birds, sceneries, colourful butterflies etc. in the vicinity, we enjoy it and feel happy.



Why are we able to see the objects?



What is required?

a small plain mirror and a laser torch

What to do?



Figure 5.1



Figure 5.2

- Take a small plane mirror. Allow light from laser torch to fall on the mirror and try to see the reflection of light on a wall or on clothed screen.
- The bright ray of light is reflected from polished and smooth surface of the plane mirror. Similarly, light from the surrounding comes back from the objects, which enters in our eyes, which makes us see the objects but we do not see the reflected ray of light.
- The Phenomenon of ray of light, coming back after getting incident on surface of an object is known as reflection of light.

5

Mirrors and Reflections

When we observe objects, animals, birds, sceneries, colourful butterflies etc. in the vicinity, we enjoy it and feel happy.



Why are we able to see the objects?



What is required?

a small plain mirror and a laser torch

What to do?

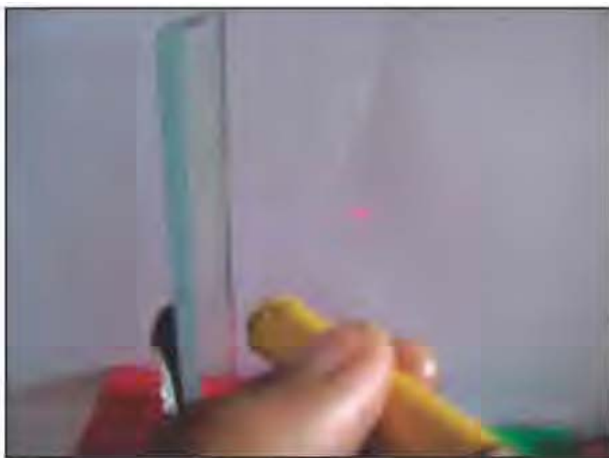

Figure 5.1



Figure 5.2

- Take a small plane mirror. Allow light from laser torch to fall on the mirror and try to see the reflection of light on a wall or on clothed screen.
- The bright ray of light is reflected from polished and smooth surface of the plane mirror. Similarly, light from the surrounding comes back from the objects, which enters in our eyes, which makes us see the objects but we do not see the reflected ray of light.
- The Phenomenon of ray of light, coming back after getting incident on surface of an object is known as reflection of light.

5 ♦ Mirrors and Reflections



Let us understand the phenomenon of reflection of light

What is required? a plane mirror, a stand, a drawing paper, a torch, a scale, a pencil

What to do?

- Place the drawing paper on a plain surface.
- Draw a line segment AB on paper as shown in Fig.
- Place a plain mirror vertically on it.
- Allow ray of light from torch to be incident on the surface show of plain mirror by adjusting the torch very near to the surface show the path of the ray of laser light.
- Mark points P and Q shown in Fig. 5.4 on the path generated by ray of laser light using pencil.
- Similarly, mark points R and S as shown in fig. on the path generated by reflected ray of laser light using pencil. Remove the plain mirror from the paper.
- Draw the ray PQ passing through points P and Q.
- Draw the ray RS passing through points R and S.
- Mark point 'O' on line segment \overline{AB} where the ray \overrightarrow{PQ} and ray \overrightarrow{RS} intersect using pencil.
- Draw a \overrightarrow{ON} perpendicular to AB from point 'O'
- You will be able to see the figure as follows on the paper.

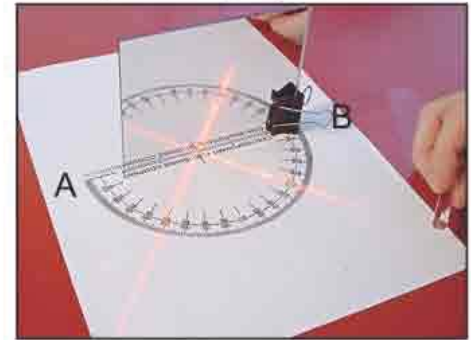

Figure 5.3

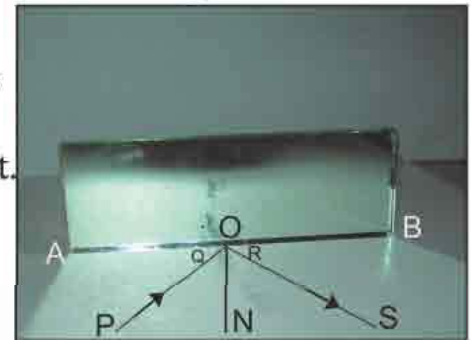

Figure 5.4

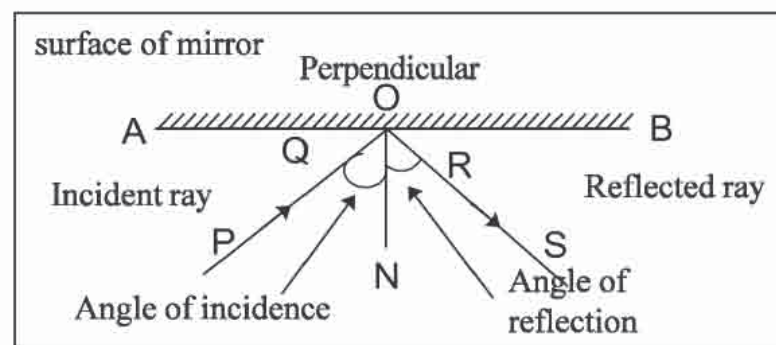

Figure 5.5

5 ♦ Mirrors and Reflections

- **Incident ray** – The ray of light coming from laser torch on the surface AB of plane mirror at point 'O' is an incident ray as shown in Fig. \vec{PQ} is an incident ray.

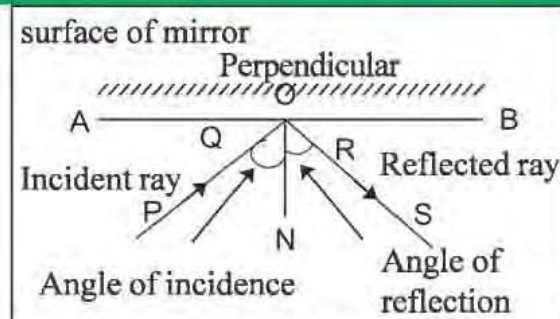

Figure 5.6

- **Point of incidence** : The point on the surface AB of a plane mirror where the incident ray from laser torch incident is known as point of incidence as shown in fig. 5.6 'O' is the point of incidence in the figure.
- **Perpendicular (normal)**: A line making an angle of 90° with surface AB of plain mirror at point of incidence 'O' is known as perpendicular (normal)
- **Angle of incidence** : Angle subtended between incident ray and perpendicular at point of incidence is known as angle of incidence. $\angle PON$ shown in the fig. is the angle of incidence
- **Reflected ray**: The ray of light coming back from point of incidence is known as reflected ray. \vec{RS} is reflected ray shown in fig. 5.6
- **Angle of reflection** : Angle subtended between reflected ray and perpendicular drawn at the point of incidence is known as the angle of reflection $\angle SON$ as shown in fig. 5.6 Repeat the activity by making ray of light incident on the plain mirror and prepare the tabulation as given below.

Trial of expt.	Angle of incidence (in degree)	Angle of reflection (in degree)
1		
2		
3		

- Is the angle of incidence and reflection remain same or different in each trial?

- Are the ray of incidence and the ray of reflection on the same side of the perpendicular or opposite side?

5 ♦ Mirrors and Reflections

- Does the plain of incident ray, reflected ray and perpendicular changes or remains the same?
-
-

The following rules can be deduced from these observations.

- **Laws of reflections of light:**
 - Incident ray and reflected ray are on the opposite sides of the perpendicular drawn from point of incidence.
 - The level of incidence and angle of reflection are always equal.
 - Incident ray, reflected ray and perpendicular drawn from point of incidence are in the same plane.



What is required? a polished paper, a torch, a plane paper

What to do?



Figure 5.8



Figure 5.9

- Take a polished paper, observe your face in it,
- Make light incident on polished paper and try to observe reflection on the simple paper
- Rush the polished paper slowly and try to see your face in it.
- Make light incident on this wrinkled paper and observe the reflection on plane paper.

Note your observations

We can observe that parallel rays made incident on polished surface get reflected parallelly, such reflection is known as a **uniform reflection**.

5 ♦ Mirrors and Reflections

While parallel rays made incident on uneven surface (wrinkled polished paper) does not get reflected, such reflections are known as **non uniform reflections**.

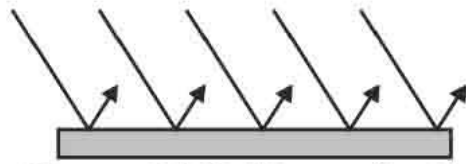

Figure 5.9 Uniform reflections.

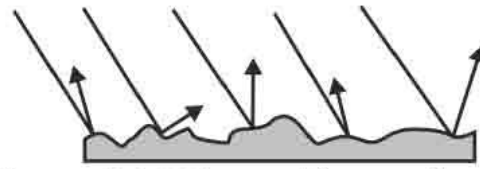

Figure 5.10 Non-uniform reflections.



Why do we see sometimes deshaped face in some special mirrors?

Think and discuss :

- Does each law of reflection obey when reflection of light takes place from an even surface? yes/no.?



Study of images obtained by reflections of light from plain mirrors.

What is required? a plan mirror, a scale, a drawing paper, two candles, a stand, a thermocole



Figure 5.11



Figure 5.12

What to do?

- Place a thermocole sheet on the table.
- Put the drawing paper on it and draw a line segment AB on it.
- Place a plain mirror on line segment AB vertically.
- Place a candle at a distance 10 cm, away from plain mirror (candle should have similar or smaller height than mirror) in front of polished surface of plain mirror

5 ♦ Mirrors and Reflections

- Try to observe the reflection of candle in the plain mirror.
- Now, adjust a little longer candle behind the mirror in such a way that the positions of both, the candle adjusted behind the plain mirror and the image of the candle in the plain mirror should coincide.
- Make sure the colinearity of the candle and the image of the candle by observing the arrangement from different positions.
- Now, remove the mirror
- Measure the distance of the position of candle placed behind the mirror from line segment AB.
- Place the candle in front of plain mirror at different distance and repeat the activity and note your observations in the following table.

Trial number	Distance of candle in front of mirror	Distance of candle at rear side of mirror	Is the size of the candle placed in front of mirror and its image observed is same or different?
1	10 cm		
2			
3			

We know that, the image that can not be obtained(received) on the screen is known as virtual image.



What is required : a plain mirror

What to do?

- Answer the following question after observing your image in plain mirror.

5 ♦ Mirrors and Reflections

- When you lift your right hand, which hand is raised in your image in the mirror.

- Which hand would / you need to raise to observe right hand raised in your image?

- If you hold the right ear, which ear would you observe hold in your image?

- Write the letters ABC on a paper and observe the image in the plain mirror.
- How do letters appear to you? Draw its figure in the following box
- Observe the images formed by placing letters A to Z in front of plain mirror.
- Which letters appear same, even in images? List them

- Write the characteristics of images formed by plain mirror based on the observations from above activities.



What is required? Two plain mirrors, a stand, a small things like eraser and sharpeners

What to do?

- Place two mirrors perpendicular to each other on stands as shown in fig. Place eraser or sharpner between mirror and observe the images in the mirrors

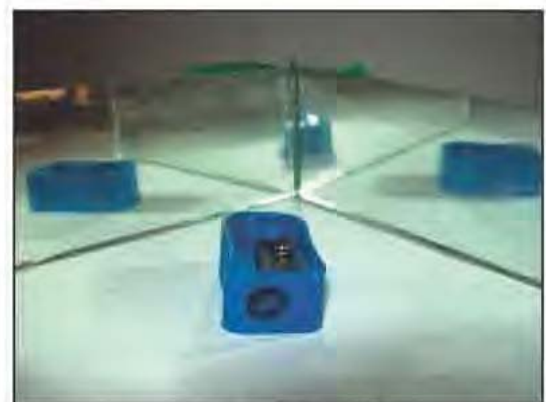

Figure 5.13

5 ♦ Mirrors and Reflections

- How many images of objects (Eraser or sharpener) are seen?

- Now, change the angles between the two mirrors by 30° , 45° and 120° and repeat the activity and note your observations in the table.

No of Trial	Angle between two mirrors	Total number of images observed
1	30°	
2	45°	
3	120°	



Does the number of images observed in the plain mirrors increase or decrease with increase in the angle between the plain mirrors?

Why do we get more than one image of an object placed between, two mirrors?

What degree angle is to be adjusted between the mirrors to get 5 images of an object placed between them?

From above activity, we can derive the following formula to find the number of images.

$$\text{No. of images} = \frac{360^\circ}{(\text{Angle between two mirrors})} - 1$$

Solve the following examples using the formula :

- Calculate the number of images formed by placing an object – between two plane mirrors when the angle between by the plain mirrors is 40° .

5 ♦ Mirrors and Reflections

What should be the angle between by two plain mirrors to get 9 images of an object kept between the two plane mirrors?



Let us prepare an apparatus which is working on the basis of the principle of reflection of light..

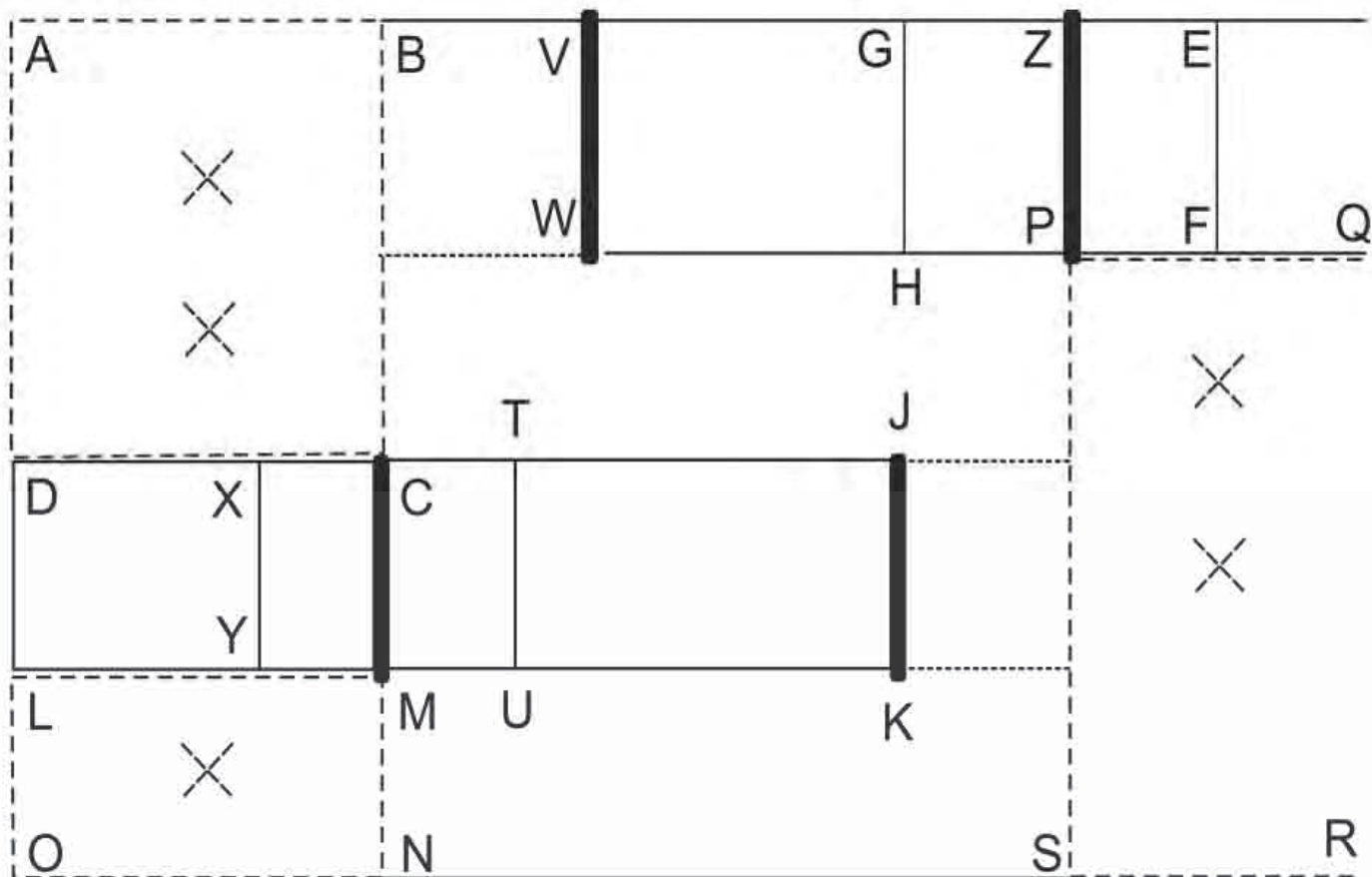

Figure 5.14

What is required? Hard board, two plain mirrors, gum, a cutter, a cissors, a scale, a pencil etc.

What to do?

- Draw the figure on a hard board as shown in fig. 5.14.
- Cut and remove, rectangular pieces ABCD, LMNO, PQRS. We observe the following type of shapes as in fig. 5.15.

5 ♦ Mirrors and Reflections

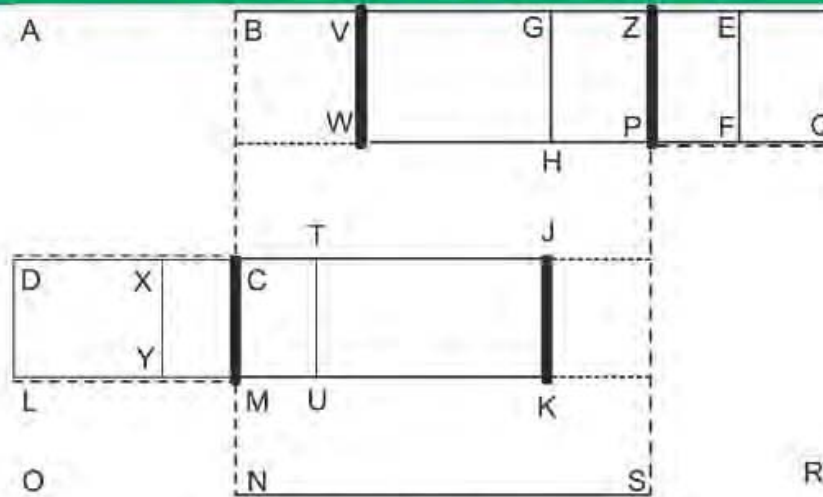

R Figure 5.15

- Put a soft cut on the hard board at W, J and K and fold the board at line segments \overline{VW} , \overline{ZP} , \overline{CM} , \overline{JK} , \overline{PW} , \overline{CJ} and \overline{MK} (Board should not get cut). Paste line segments \overline{EF} and \overline{XY} on the edges of plain mirror using adhesive tapes or gum, and paste line segments \overline{GH} and \overline{TU} at an angle 45° on the other edge as shown in fig. 5.17. We will get the structure as shown in fig. 5.17.

Paste the hard board pieces on the cut line parts. This type of apparatus is known as periscope.

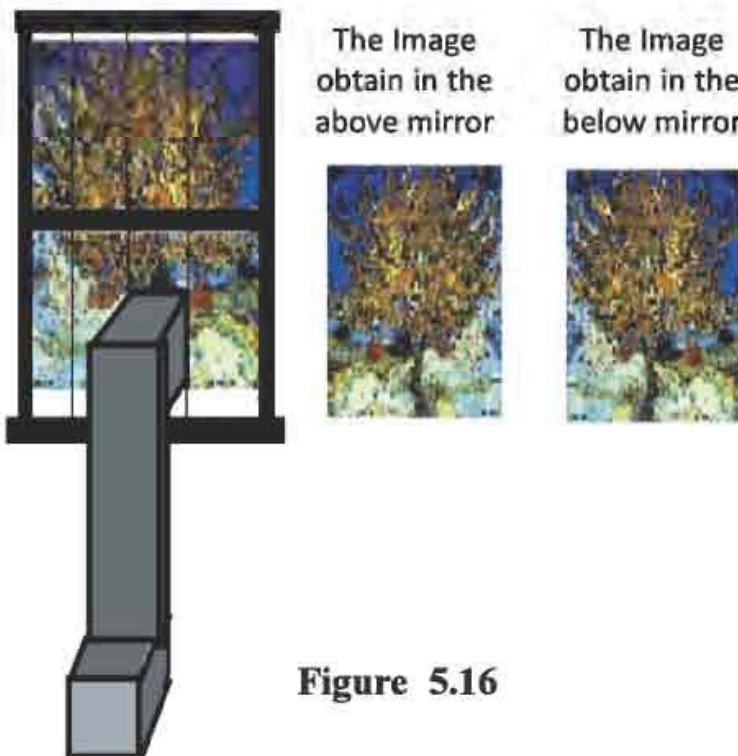

Figure 5.16

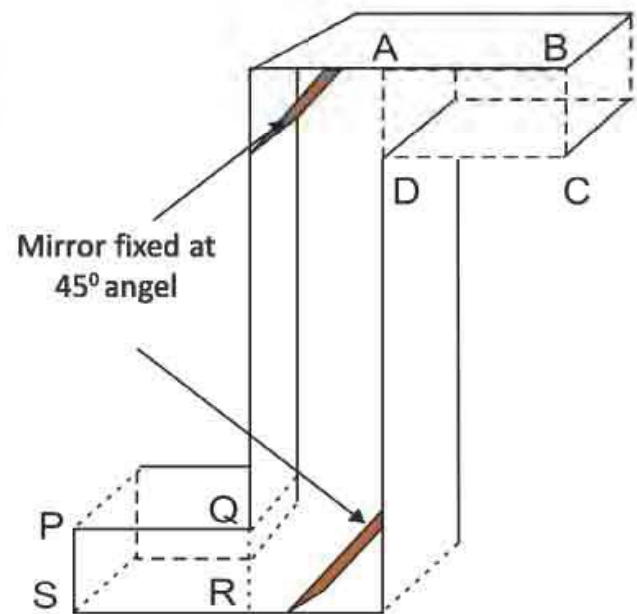

Figure 5.17

5 ♦ Mirrors and Reflections



By adjusting periscope in different positions, as shown in figure observe the sceneries outside; by hiding yourself.

Figure 5.18 Figure 5.19



- Why is the object seen even when a board is in its from, when to be seen from the end of peristion?
-
- What type of shape of periscope is required to observe, different parts of your body?



Figure 5.20



Figure 5.21



Figure 5.22



Figure 5.23

Submarines are used to travel in side sea water as the fishes do. Periscope is useful to observe the activities taking place on and above surface of sea level even keeping the submaries in deep waters. Similarly, the army requires such units (Periscopes) to observe activities of army keeping our army men hidden inside the bunkers.



Using characteristics of multiple images generated by plain mirrors, we can have a magical painter.

What is required? There are small plain mirrors of rectangular or square shape, card papers, gum, adhesive tapes, opaque plastic, small pieces of bangles, rubber bands, etc.

5 ♦ Mirrors and Reflections

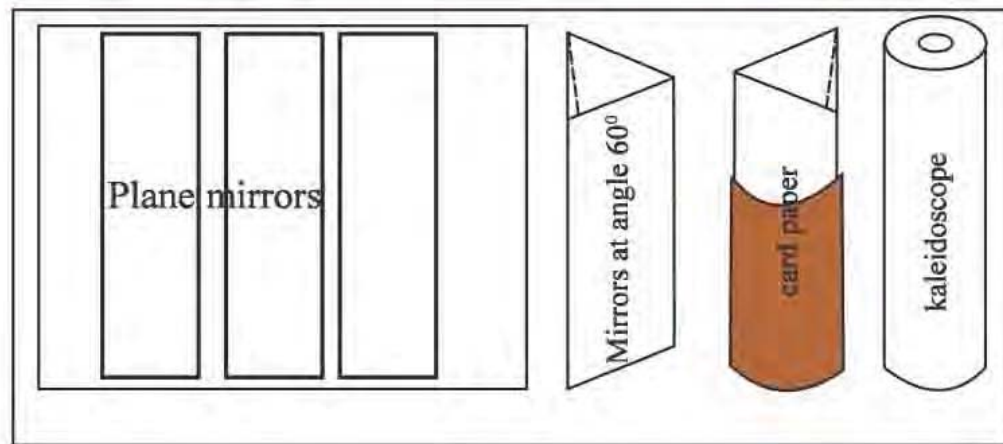

Figure 5.24

What to do?

- Paste three plain mirrors on a card paper keeping 2 to 3 mm distance between them using gum [Polished surface must be kept at the upper end.] as shown in fig. 5.24.
- Keeping the angle of 60° among three mirrors, paste them with rubber bands or adhesive tapes.
- Cover the system now with card board or card paper and close one of the ends by pasting opaque semi transparent plastic.
- Put 5 to 6 pieces of bangles from the open end. Paste a card paper on the open end and close it.
- Make a small hole at the centre of this end of the card paper. Here is our magic painter, known as kaleidoscope, rotating this kaleidoscope slowly, observe the different design.

**Why do we get such designs in kaleidoscope?**

Q.1 The word AMBULANCE is printed as shown below on the ambulance van, why?

AMBULANCE

5 • Mirrors and Reflections

Q.2 Place the plain mirrors on the side AB, in the fig.picture given below.



Q.3 Prepare a solar cooker with the help of your friends and teacher and describe the method of preparing it by listing the objects you are using for it.

Material :

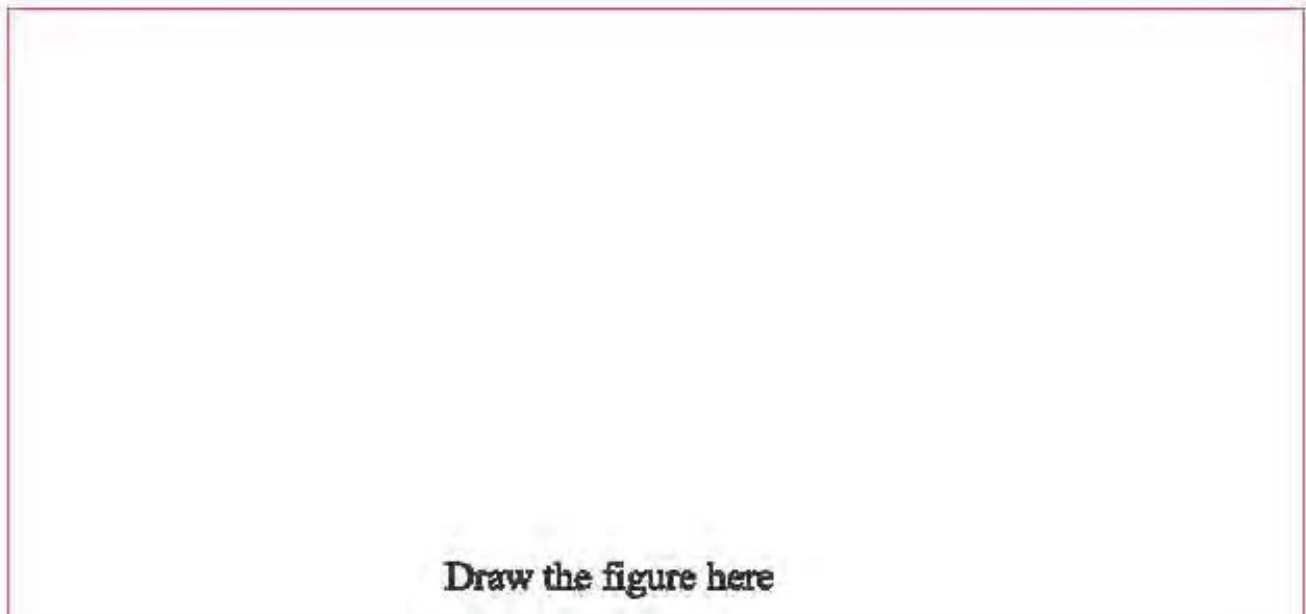

Method of preparation :

6 Curved Mirrors

You would have observed and enjoyed watching yourself at magical mirrors where you would have found your images dispel, long, short, inverted or erect inside the magical mirrors. Such mirrors are curved mirrors.



Why do we observe our images long or short, inverted or erect, thick or thin in the curved mirrors?



Take a shining, big teaspoon and observe your face on the inner and outer sides of it. What do you see ?

What shape of your face is observed in the outer shining surface of a steel glass?



Let us prepare curved mirrors (knife).

What is required? a plastic ball, a cutter,

What to do?

- Take a plastic ball. Cut the portion of the ball as shown in figure 6.1. Collect the part as observed in fig. 6.2.

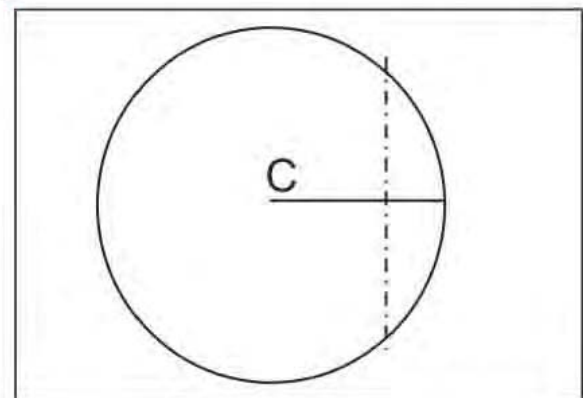

Figure 6.1

6 ♦ Curved Mirrors

- Just like the part cut from the plastic ball, similarly such parts are cut from hollow glass balls and curved mirrors.
- There are two types of curved mirrors
 - 1 Concave mirrors
 - 2 Convex mirrors

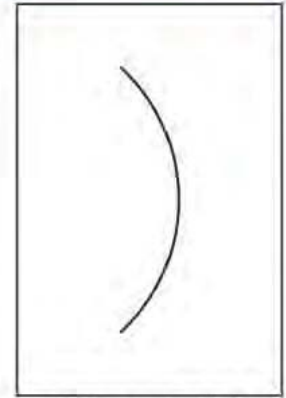

Figure 6.2

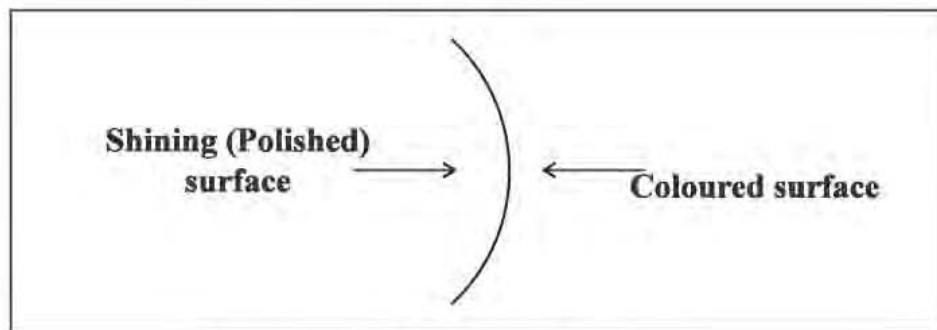

Figure 6.3 Concave mirrors

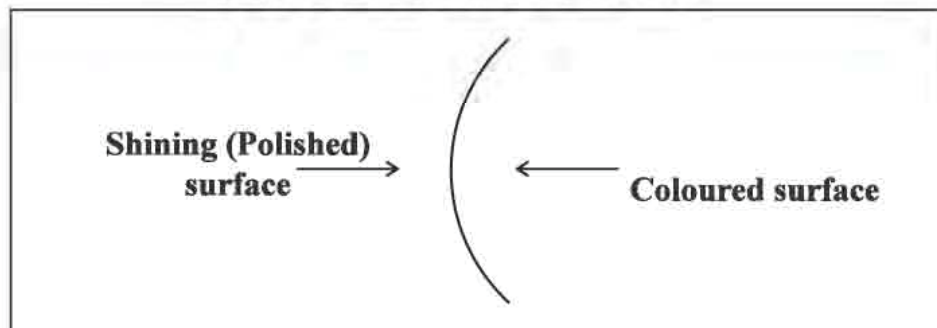

Figure 6.4 Convex mirrors

Some of the mirrors are polished internally and external curved surface are coloured. Such mirrors are called **concave mirrors**.

Some of the mirrors are polished externally and internal curved surfaces are coloured. Such mirror is called **convex mirror**.



What is required? Watch glass, shining paper, water colour, gum, brush etc.

What to do?

- First of all take watch glass.
- Paste shining paper on the inner curved surface with gum

6 ♦ Curved Mirrors



What is required? Concave mirror, Convex mirror,

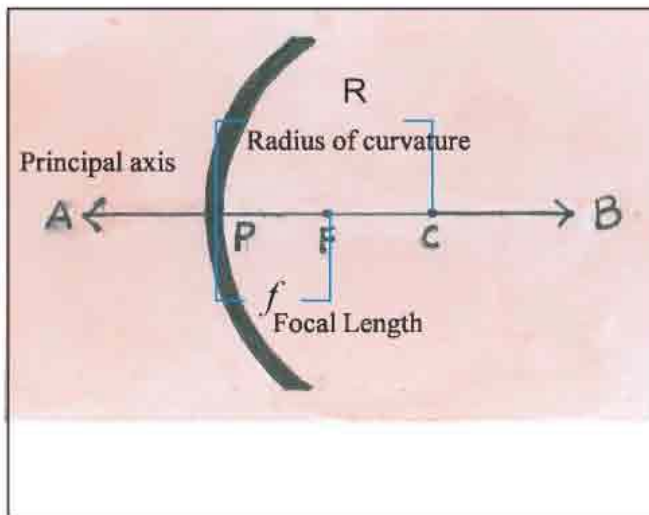

Figure 6.6
Concave mirror

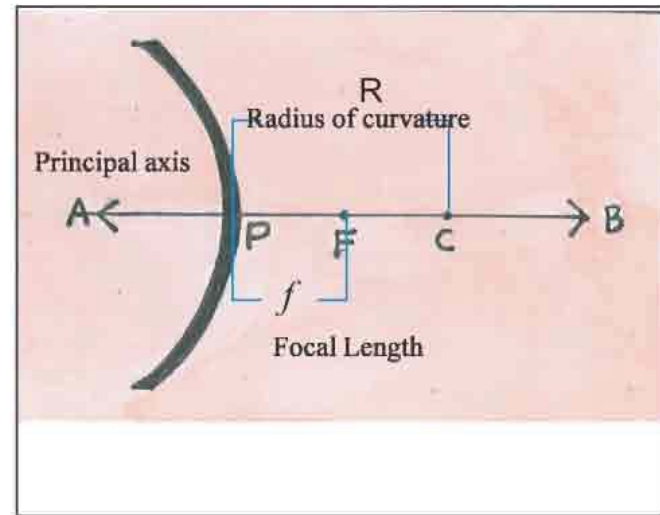

Figure 6.7
Convex mirror

What to do?

- Take one concave mirror and one convex mirror, Observe it and try to get acquainted with ITS terminology.
- **Pole :** the centre of the curved surface of the mirror is known as pole P is pole point.
- **Centre of curvature:** The centre of the hollow sphere from which curved mirror is cut is called centre of curvature is the centre of curvature in figure.
- **Radius of curvature:** The distance between pole point and centre of curvature (C) is called radius of curvature. The line segment CP in fig. is radius of curvature. It has a symbol R. Thus $CP = R$
- **Principal axis:** The virtual line passing through pole point and centre of curvature is known as principal axis. The line AB, is in figure represents principal axis.

6 ♦ Curved Mirrors



What is required? a concave mirror, a torch, a paper, a stand.....

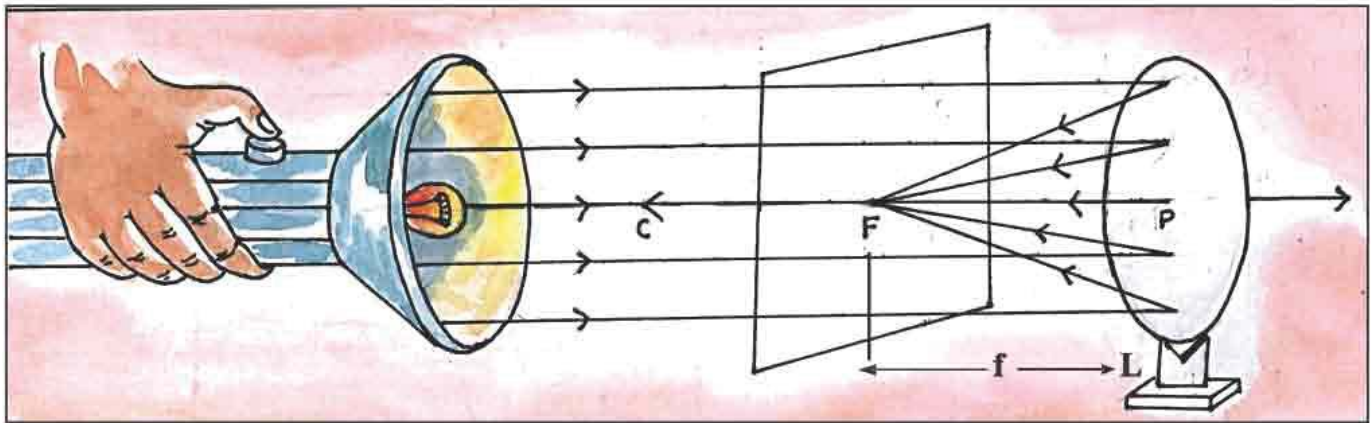

Figure 6.8

What to do?

- Take one concave mirror and adjust it on a stand as shown in the figure.
- Keep the torch at a distance larger than that of centre of curvature of mirror and allow the light to fall on it.
- Try to capture the point size image of rays of light reflected from concave mirror, on the paper and note your observation.
- Do you get point sized image of rays reflected from concave mirror? Yes/ No.
- **Principal focus :** The rays of light made incident parallel to the principal axis horizontally, gets, (converged) concentrated at a point on the principal axis after getting reflected from the concave mirror. A point on the principal axis is known as principal focus or principal focal point of concave mirror. As shown in fig., F is the principal focus (Principal focal point).
- Similarly, in case of concave mirror the reflected rays of light reflected from polished surface do not converge at a single point but they diverge, then those diverging rays of light can be virtually, imagined and extended backward at one point, such a point is focal point of convex mirror.
- **Focal length :** The distance between pole point and the principal focus of a curved mirror is known as focal length of that curved mirror, It is represented by symbol (f) as shown in the Fig.

6 ♦ Curved Mirrors

- **Relation between focal length and radius of curvature.**
- Radius of curvature of a curved mirror is always double than that of focal length F . thus, $R = 2f$ or $f = R/2$
- Calculate the following using the above formula.
- What will be the focal length of a curved mirror if it has 10 cm radius of curvature?

- If focal length of a curved mirror is 6 cm then what will be its radius of curvature?



Characteristics of image obtained by using concave mirror

What is required? a concave mirror, a candle, a match box, a drawing paper, a mirror stand, a candle stand

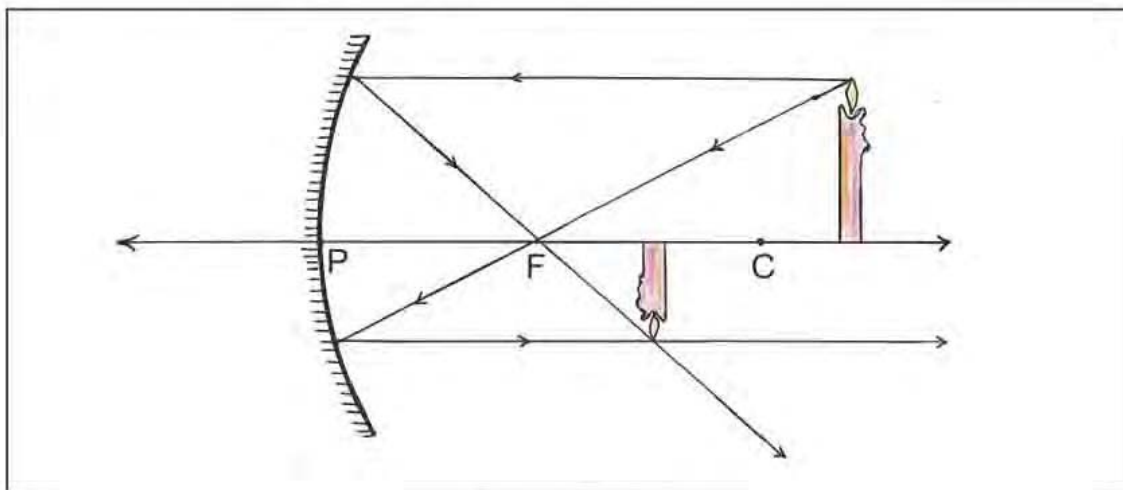

Figure 6.9

What to do?

- Adjust the drawing paper on a plain surface as shown in the figure.
- Adjust the concave mirror on stand on it.

6 ♦ Curved Mirrors

- Mark Principal focus F and centre of curvature C of concave mirror on it.
- Place a candle using candle stand on it at distance higher than radius of curvature in front of the concave mirror and light the candle.
- Capture the image of the flame of candle on a drawing paper and write your observations.
- Position of candle:
- Position of image:
- Which type of image is observed? Errect / inverted:
- How does the image appear ? Smaller / bigger than the flame of candle.

As in above activity, one of the rays of light coming from candle made incident on the concave mirror paralld to principal axis horizontally, passes through principal focus after reflection and the other which made incident on concave mirror after passing through principal focus get reflected parallel to the principal axis. All such rays converge at a point where the image of the object is obtained.

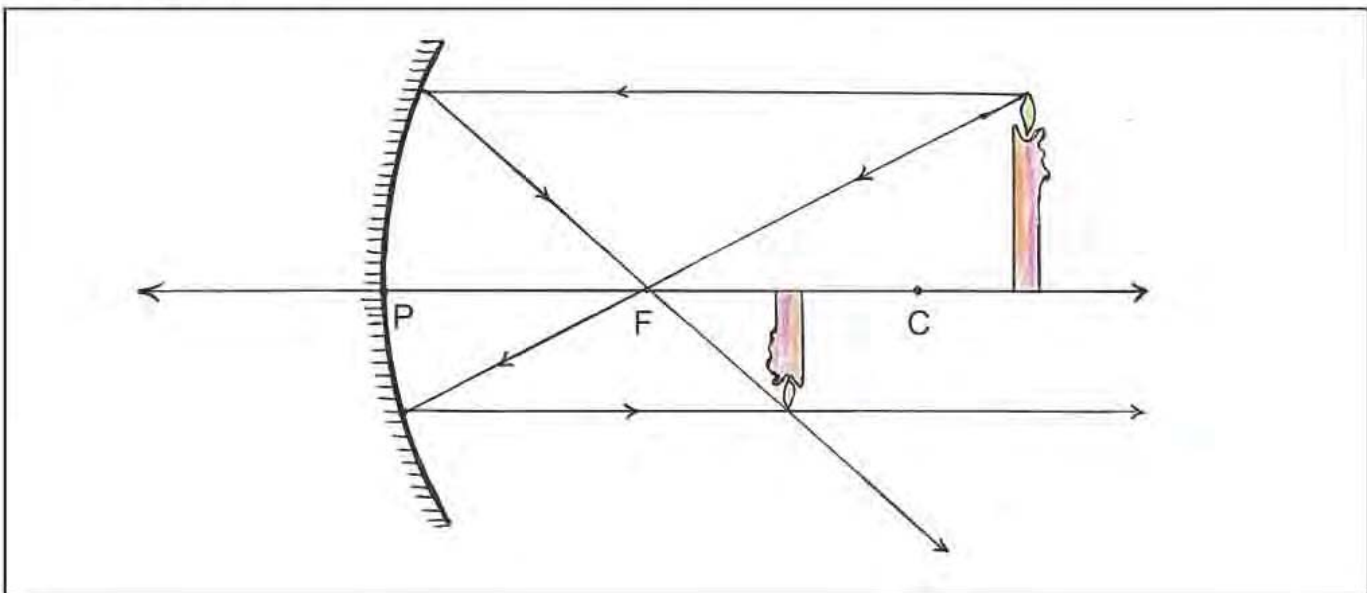

Figure 6.10



Repeat the above activity, keeping the candle at different positions as shown in the following table and note the position of image, type of images and other characteristic.

6 ♦ Curved Mirrors



Discuss in each case, in which you get which type of images, and why you get it like that with your teacher.

Position of candle	Position of image	Type of image of candle			Position of rays
		erect or inverted	biger or smaller than flame of candle	Real / virtual	
At radius of curvature					<p>Figure 6.11</p>
Between radius of curvature and principal focus					<p>Figure 6.12</p>



Observe the following figure 6.13

As in above activity, when the candle is placed between point P and Point F of a concave mirror, the rays coming out of object (candle) gets, incident on the mirror and after reflection passes through principal focus C. while some of them travelling in the direction of radius of curvature get reflected in the same direction and passes through centre of curvature C.

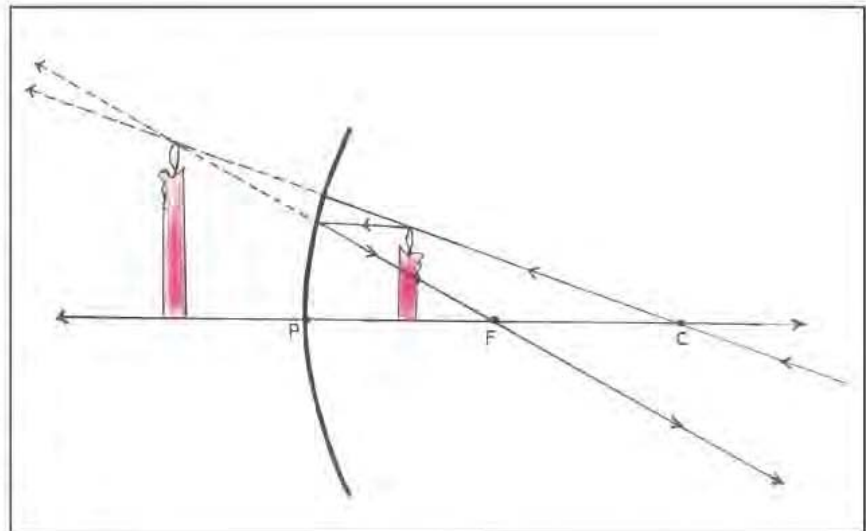

Figure 6.13

Thus, drawing of the path of rays indicate these rays do not interesection on one side of the mirror but we need to extend them virtually to understand the point of intersection of there rays. Which we get at a position behind the concave mirror. Thus, these rays appear to interesection behind the mirror at some point where we get the image of the object (candle), which is big in size, erect and virtual image.

6 ♦ Curved Mirrors

These characteristics of images obtained by curved mirrors are useful in daily life. Some of the pictures of objects in which we use curved mirrors are shown. Observe them carefully and write the characteristics used in the table.

Pictures showing use	For which characteristic it is used?
	
	
	
	



Write the other uses of curved mirror you have observed :

6 ♦ Curved Mirrors



Let us prepare a parabolic solar cooker

What is required?

An earthen pot, a curved metal sheet, polished aluminum foil, gum, a wooden stand, a nut bolt etc.

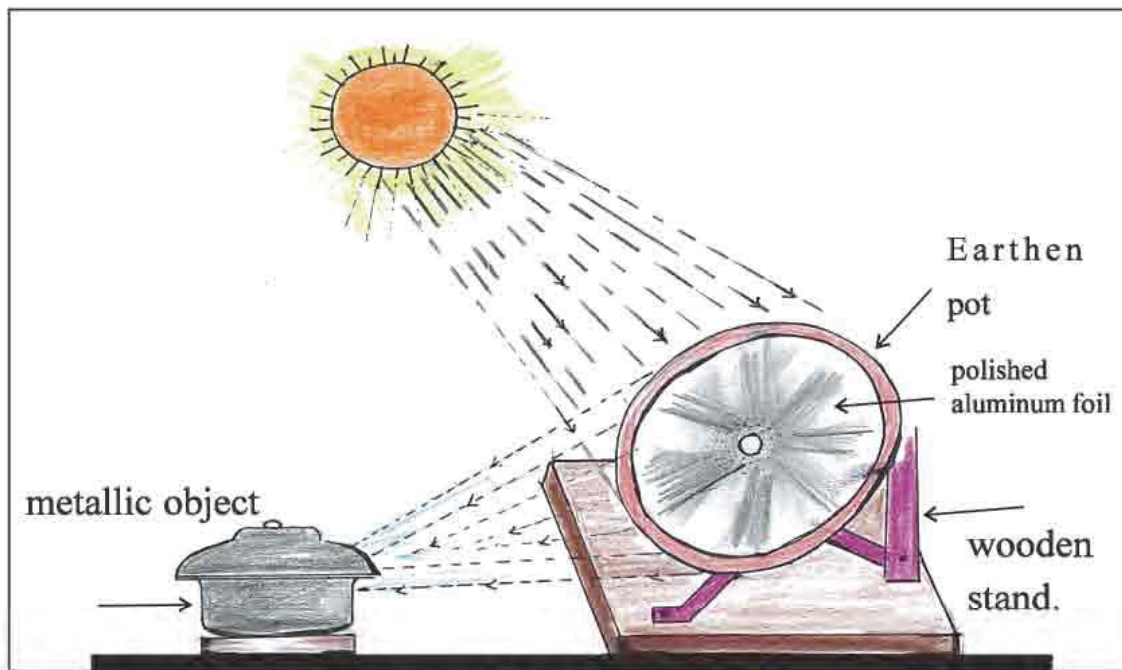

Figure 6.14

What to do?

- Take the curved earthen pot, paste the polished aluminum foil inside it.
- Prepare a hole at the centre of sheet and using nut bolts get it fitted on the wooden stand.
- Adjust this arrangement in front of sun light in such a way that the reflected sun light gets focussed at a single point.
- Place a metallic object at that place and observe it after some time.
- Note your observations.

6 ♦ Curved Mirrors



Characteristic of images observed in convex mirrors.

What is required? a convex mirror, a mirror stand, a candle, a candle stand, a match box, a drawing paper

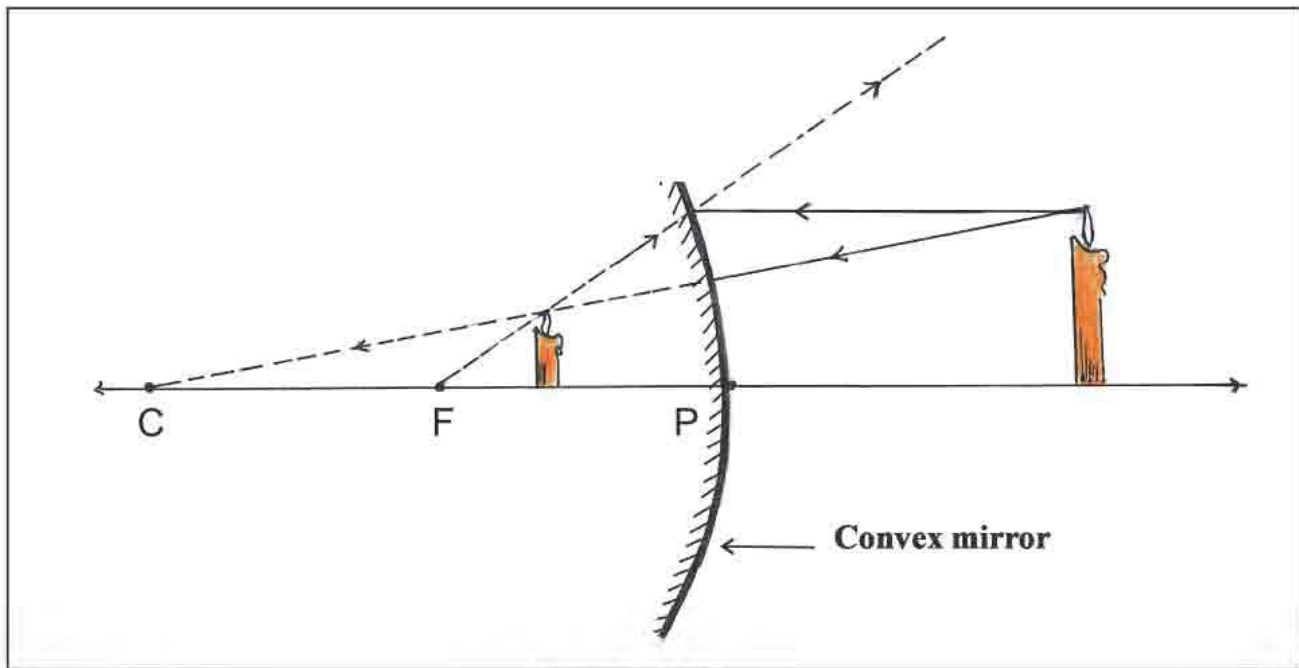

Figure 6.15

What to do?

- Place a drawing paper on plain surface
- Place the stand and mount the convex lens on it.
- Adjust a candle on stand in front of the convex mirror as shown in the fig.
- Try to obtain the image on the paper or screen, observe the image and note the observation of image.
- position of candle :
- position of image:
- What type of image is ? Erect / Inverted:
- What is the size of image? bigger / smaller, than the size of the candle:

6 ♦ Curved Mirrors

- Can we obtain the image on screen? Yes/ No
- Type of image : Real / virtual



Discuss how and why formation of image obtained during above activity takes place using convex mirror with your teacher and draw the diagram.

Uses of convex mirror :

Due to the type of images obtained using convex mirrors, they possess special characteristics and are accordingly useful in daily life.



Figure 6.16



Figure 6.17



Figure 6.18

Note other uses of convex lense, you have seen.



- Q.1** Why is it written as “objects in the mirror are closer than they appear”, on the side glasses of motorbikes or scooter or cars?

6 ♦ Curved Mirrors

Q.2 Why are big convex mirrors placed in front of reception tables of some hotels or big shopping malls?

Q.3 Mention in the following figure, what is the position of rays which obtaining image of an object placed in centre of curvature in concave mirror.

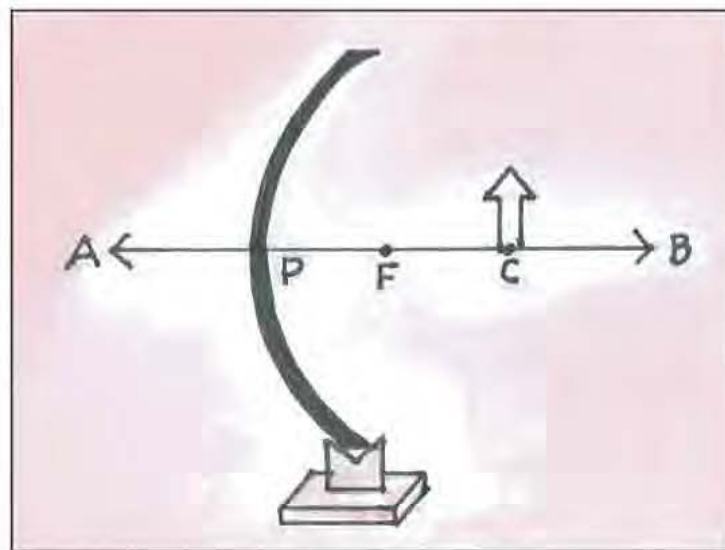

Figure 6.19

Q.4 Why are concave mirrors used in search lights?

Q.5 What type of image is obtained while using convex mirror when the object is far away from mirror?

7

Element, Compound and Mixture

Varieties of things are found around us. If we see a new thing, at once we are anxious to know about it, from what is it made? Isn't it true?

- Any word in English language is made by using 26 alphabets from A to Z.
- Thus 26 alphabets from A to Z are the basic units of English language.
- Any number is composed from 10 digits from 0 to 10.
- Thus 10 digits from 0 to 9 are the basic units for number system.

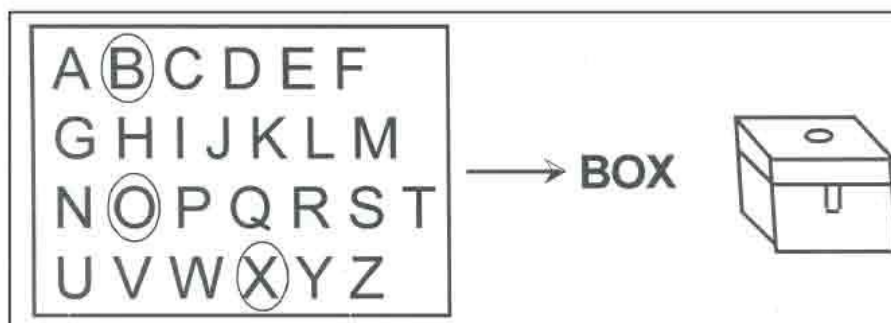

Figure 7.1

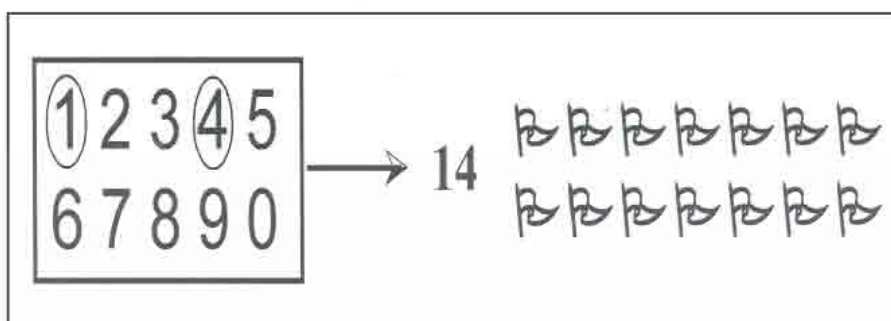

Figure 7.1

Exactly in the same manner, all the substances around us are composed from the basic units. Such basic units are called 'Elements'. There are 118 such elements.

In the study of Science for convenience, instead of writing the full name of the element they are expressed with symbols. Any symbol is expressed by the first letter of the name of the element either in English or Latin.

Such as **H** is the symbol for hydrogen. If the first letter is allotted for the symbol of another element then the symbol consists of first two letters of the name of the element. In this symbol the first letter is capital and the second letter is small one.

eg. The symbol for Helium is **He**.

Sometimes the symbol is composed of the first letter and the third letter.

eg. The symbol for Magnesium is **Mg**.

7 ♦ Element, Compound and Mixture



No	Name of the Element	Latin name	Symbol
1	Hydrogen	—	H
2	Helium	—	He
3	Lithium	—	Li
4	Beryllium	—	Be
5	Boron	—	B
6	Carbon	—	C
7	Nitrogen	—	N
8	Oxygen	—	O
9	Fluorine	—	F
10	Neon	—	Ne
11	Sodium	Natrium	Na
12	Magnesium	—	Mg
13	Aluminium	—	Al
14	Silicon	—	Si
15	Phosphorus	—	P
16	Sulphur	—	S
17	Chlorine	—	Cl
18	Argon	—	Ar
19	Potassium	Kalium	K
20	Calcium	—	Ca

7 ♦ Element, Compound and Mixture

Elements are composed of very minute particles which are not visible by naked eye or even by a microscope. While atoms are known, one atom, molecule or a group of the same type of atoms is called an element. Atoms is a constitutional unit.

**What is required?**

a magnesium strip, a pair of tongs, a candle, a match box

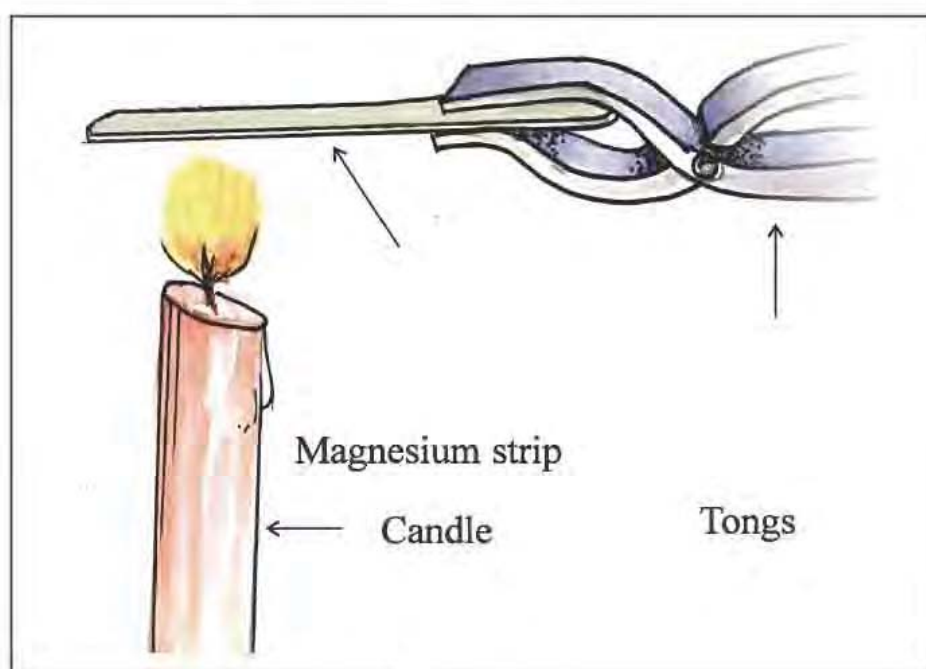

Figure 7.3

What to do?

- Hold a magnesium strip with a pair of tongs.
- Light a candle and then keep one end of the magnesium strip on the flame.
- In the same position, keep the strip steady near the flame for some time.
- What happens? Note your observation here below.

7 ♦ Element, Compound and Mixture

Burning the magnesium strip, we get ashes in white colour. Observe the ashes properly and you will see that the new substance (ashes) obtained by burning the magnesium strip has totally different properties other than the properties of magnesium.

Compound : When two or more elements combine by a chemical reaction together in a definite proportion and form a new substance losing the individual fundamental properties of the elements and possess totally new properties, this new substance is called a compound.

In the activity we performed, magnesium combines with the oxygen from the air and forms a new compound called 'Magnesium oxide'.

In the Compound :

- More than one element combine in a definite proportion.
- Every element loses its original properties and the compound takes totally new properties.
- Hydrogen (H) is an inflammable gas.
- Oxygen (O) helps combustion.
- Two Atoms of the element Hydrogen combine with one atoms of the element Oxygen (O) and one molecules of water is formed.
- Water is a compound in a liquid form.
- It helps in extinguishing fire.



In your class and with the teacher have a discussion about such types of examples.



What is a molecule?

- Two or more atoms of the same type or of the different types combine and form molecule.
- Molecule is a constitutive unit for compound.
- The atoms of more than one element combine together with each other and form a molecule of compound. eg. MgO, H₂O .

7 ♦ Element, Compound and Mixture

Sometime, the atoms of one element itself combine with each other and form a molecule of the element. Such as H_2 , N_2 , O_2 etc.

- Most of the elements found independently in nature combine their molecules with each other and form a molecule of the element. But some gases like Helium, Neon, Argon etc. exist in the form of molecule, these gases are known as inert gases.



The chemical reactions combining the elements can be written in the form of an equation

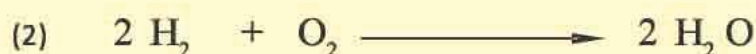

Some Known Compounds

No	Ordinary name	Chemical name	Molecules
1	Sugar	Sucrose	$C_{12}H_{22}O_{11}$
2	Common salt	Sodium Chloride	$NaCl$
3	Glucose	Glucose	$C_6H_{12}O_6$
4	Baking powder	Sodium bicarbonate	$NaHCO_3$
5	Washing soda	Sodium carbonate	$Na_2CO_3 \cdot 10H_2O$
6	Blue - vitriol	Copper Sulphate	$CuSO_4 \cdot 5 H_2O$
7	Caustic soda	Sodium hydroxide	$NaOH$
8	Water	—	H_2O

7 ♦ Element, Compound and Mixture



What is required? Common salt, Iron filings, Two sheets of paper, magnet bowls.

What to do?

- Take some common salt on a sheet of paper.
- Move a magnet over it.
- What did you see?

- Take iron filings on a sheet of paper.
- Move a magnet over it.
- What did you see?

- Now mix salt and iron filings together.
- Move a magnet over it.
- What did you see?

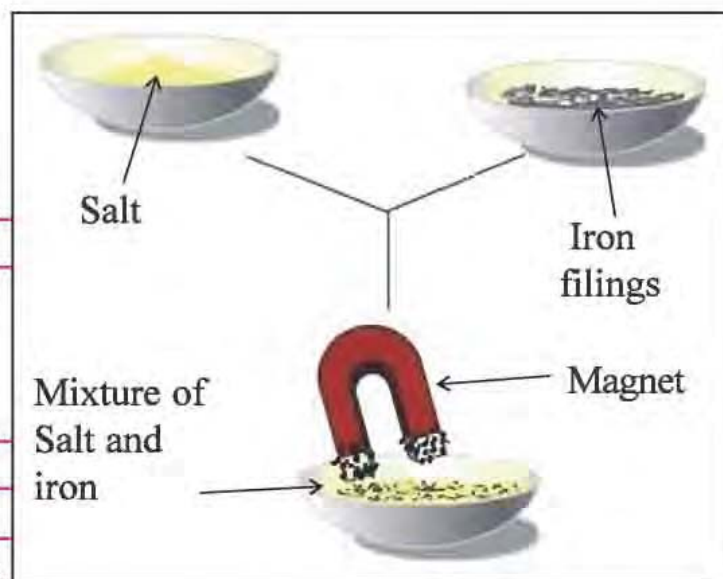

Figure 7.4



Here which method of 'Separation' is used?

More than one element or substance mix together with each other in any proportion and make a mixture. The elements or substances in a mixture do not have any chemical reaction with each other hence they preserve their own fundamental properties. There are three types of mixtures.

- (1) Mixture of element and element: Mixture of Iron and Sulphur.
- (2) Mixture of element and compound: Mixture of Iron and common salt.
- (3) Mixture of compound and compound: Solution of common salt (mixture of water and common salt).

7 ♦ Element, Compound and Mixture

You have already studied about the constitution of air. Is it a compound or a mixture?



Q.1 Selecting the proper choice from the given choice, answer the following questions :

- (1) From the following _____ is an element.
(a) Sugar (b) Common salt (c) Oxygen (d) Air
- (2) Separate the one which differs from the other.
(a) Air (b) Water
(c) Soil (d) Mixture of rice and pulses
- (3) Which of the following is not a compound?
(a) Sugar (b) Common salt (c) Water (d) Gold

Q.2 The list of some substances is given below. Classify them as element, Compound and mixture :

oxygen, air, carbon dioxide, iron, soil, sugar, water, silver.

Q.3 Give differences :

- (1) Element and Compound.
- (2) Compound and Mixture.
- (3) Element and Mixture.



8

Musculo - Skeleton System

- What would happen if there are no bones in our body ?
-
-

Our body has definite shape and volume. The structure which provides us shape and support is known as skeleton. Skeleton is made up of different bones. We also call it skeleton system.

There are ligaments between different bones of our body. There are elastic ligaments between the joints.

Thus structure made up of bones and ligaments is known as skeleton system. It provides shape and support to our body and protects the soft internal organs.

Bones are found joined in our body. These are called joints or ligaments.



Figure 8.1

- Where do we have joints in our body as shown in the figure?
-
-

- Where the flexible joints are found in our body?
-
-

- Where are the inflexible joints found in our body?
-
-

8 ♦ Musculo - Skeleton System

Thus some bones are connected with each other with movable joints which are called Movable joints while some bones are linked to another bone by immovable joints. Such joints are known as immovable joint.

(1) Bones of head :

Bones of skull and face forms our head. Soft organ like brain is protected here. It consists of $8 + 14 = 22$ bones.



2. Rib cage :

The diagram shows rib cage. Organs like lungs, heart are protected here. It consists of 12 pairs of ribs and one main bone. Thus there are total 25 bones.



Figure 8.3

3. Vertebral column :

The structure shown in the figure is vertebral column. It is made up of many vertebrae. Soft pad like structure is found between adjoining vertebrae which provides elasticity and flexibility. It protects the spinal cord. It is made up of 33 bones.

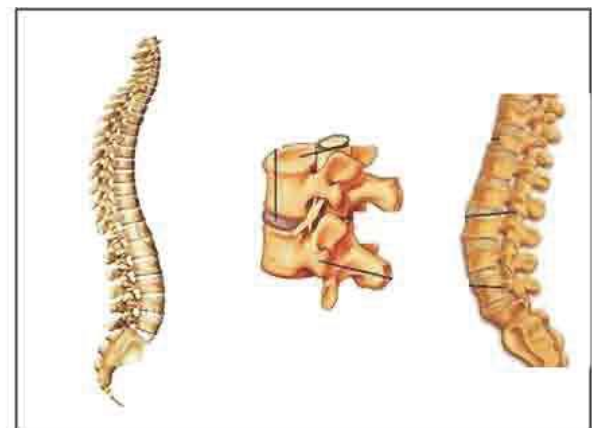

Figure 8.4

(4) Hand :

Each hand comprises of total 30 bones. Among which 19 bones are found in the paw.

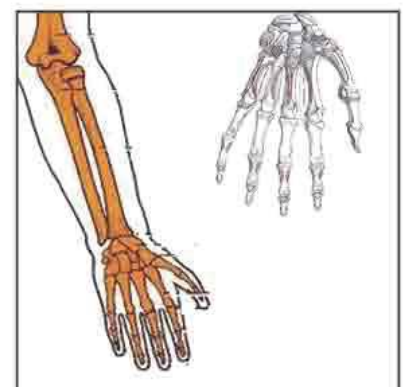

Figure 8.5

8 ♦ Musculo - Skeleton System

5. Leg :

Each leg comprises of 30 bones. Among which thigh bone (femur) is the longest and strongest.

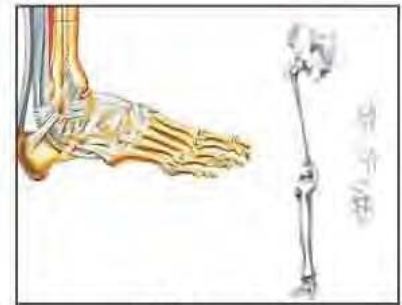

Figure 8.6

6. Pectoral girdle :

Pectoral girdle is found connected with the chest bone towards the ventral side, while it is connected to the vertebral column with the help of muscles on the dorsal side. It comprises of 4 bones.



Figure 8.7

7. Pelvic girdle :

Pelvic girdle are connected to the thigh bone on the ventral side while it is connected to the vertebral column on the dorsal side. While it is connected to the bones of legs on the lateral sides, it is comprised of two bones. Six bones of ear and a pelvic bone together make the total 213 bones in our body.



Now, perform an activity to understand the movement of your joints and put yes / no in the following table.

Parts of Body	Movement				
	Move completely	Moves/Band slightly	Moves downward	Moves upward	Can not be moved
Neck	No	Yes	Yes	Yes	-
Wrist					
Fingers					
Palm					

8 ♦ Musculo - Skeleton System

Parts of Body	Movement				
	Move completely	Moves/Band slightly	Moves down ward	Moves upward	Can not be moved
Back					
Head					
Elbow					
Hand	Yes	Yes	Yes	Yes	
Eyes					



We understood about the bones. Now you push your hand or leg gently. What do you between bones and skins?

Thus the mass of tissue, which contract as well as relax or can change the position of an organ is called muscle tissue. Different muscles of the body form muscular system.

Muscles are of two types :

(1) Voluntary muscles :

Muscles whose contraction and relaxation are under our control are called voluntary muscle e.g muscles of hand and legs etc.

(2) Involuntary Muscles :

Muscles so elastic that they whose contraction and relaxation are not under our control are called involuntary muscles e.g. muscles of lungs, heart etc.

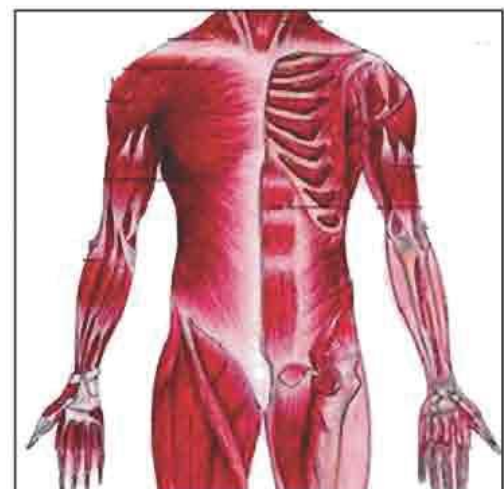

Figure -8.8

Functions :

- Muscles can be contracted or relaxed.
- Their function is to help in movement.

8 ♦ Musculo - Skeleton System



1. Of what is the skeleton formed?

2. In which bones of body are ligaments present?

3. Which is the longest and strongest bone of the body?

4. Which organ of our body is protected by vertebral column?

5. Which structure protects brain?

6. How many types of joints are found in body ? Which are they?

7. Which structure protects lungs and heart?

8. Where do you find spinal cord in body ?

9. How many types of muscles are found in body? which are they ?

10. If bones were not present in our body than.....



9

Heat and Temperature

Heat is very important in daily life. Some objects are hot, some object are cold in our surroundings. If following objects are placed open what happens to them ? Write your experience.

Hot tea in a cup

Ice cream

Hot water

Plate placed in sunshine



Hot body placed in open space lose heat and cold object placed in open space lose coldness. Hot body releases heat in atmosphere. Cold body absorbs heat from atmosphere.

What is required? Four bottles of same size, water, ink or colour, a card paper.



Figure 9.1



Figure 9.2

9 ♦ Heat and Temperature

What to do?

- Take four similar bottles.
- Fill one with hot water and other with cold water.
- By adding two-three drops of ink or colour make water coloured.
- Fill plain cold water in remaining two bottles and place card paper on it.
- As shown in the figure, place this bottle on the coloured water bottle inverted.
- Slowly, remove the card paper and observe the water in bottle.



What is seen in inverted bottle when card paper is removed?

From which bottle which bottle does the diffusion of water particle take place? Why?

Water of which bottle is not coloured. Why?

Heat transformation takes place from hotter body to less hot body. When two objects, having different temperature, are in thermal contact, the heat will be transferred from higher temperature to lower temperature. This process will continue till temperature of both substances becomes equal. It is called thermal equilibrium.



Do the following activity to understand thermal equilibrium

what is required ? a cup of glass, hot water, a pan, cold water

What to do?

- Fill a cup of glass with hot water.
- Fill cold water in the pan.
- Place a cup of glass in the pan.



Figure 9.3

9 ♦ Heat and Temperature

- After some time, touch the water in pan and note the observation.

There are two friends near by you. Touch the wrist of their hand and try to experience the heat of their body and note in following table.



Figure 9.4

No.	Name of friend	Hot or cold with respect to your body?
1		
2		
3		
4		



Why do we blow up while drinking tea?



What is required? Two small similar pans, a spirit lamp, a tripod stand, water

What to do?

- Take two similar bowls.
- Fill one bowl half with water. Fill other bowl full with water.
- Give heat to both the bowls with spirit lamp for same time.
- Then touch the water of both the bowls and note your observations.



Figure 9.5

9 ♦ Heat and Temperature



Water in which bowl is hotter?

Water in which bowl is less hot?

Why is water of both bowls not equally hot on supplying heat for same time?



Figure 9.6

On supplying same heat, the heat energy of objects may be different. Because heat energy depends on the mass of substance.

Total kinetic energy of the atoms of object is the thermal energy of object.



A person is standing at the bank of pond with a cup of tea. Then heat of water of pond or hot tea, which has more heat?

We experience heat. We can get idea about the heat of object by touching it. To understand this, let's do an activity.



What is required? Three similar large bowls, water

What to do?

- Take three similar bowls.
- Fill one with cold water and second with hot water.
- Fill third one with luke warm water.

9 ♦ Heat and Temperature

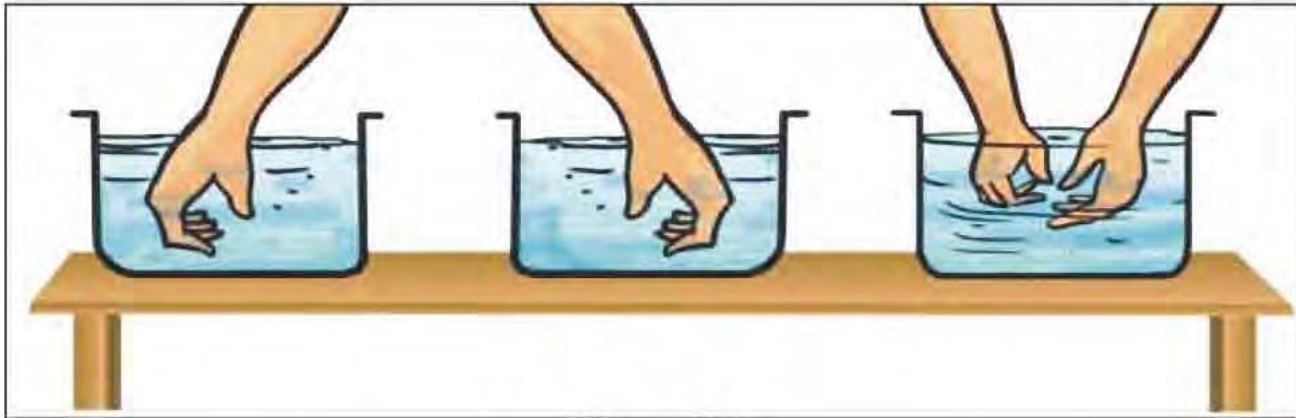

Figure 9.7

- Now insert your left hand in first bowl and right hand in second pan for some time.
- After some time place both the hands in luke warm water of third pan.

What is experience of left hand in first bowl?

What is experience of right hand in second bowl?

What is experience of left and right hand in the third bowl?

Can you say whether the water in the third bowl is hot or cold? why?

The degree of hotness or coolness of any substances is called temperature.

Whether substances is how much hot or cold can be said from its temperature. If heat is supplied to body, its temperature increases and if heat is absorbed from the body, its temperature decreases. We can't decide whether the body, is hot or cold by touching it. If object is very hot the skin will burn while touching it. There is the apparatus to measure temperature.

9 ♦ Heat and Temperature

The apparatus used to measure accurate temperature of any object is called **thermometer**.



What is required? Simple thermo meter

What to do ?

- Observe normal thermometer



What do you see while observing thermo meter?

Thermometer is like cylindrical glass rod. In side it, there is thin tube at lower end of it. There is a capsule type shape. In that, alcohol or mercury is filled. In normal thermometer, the numbers are calibrated in degree Celsius.

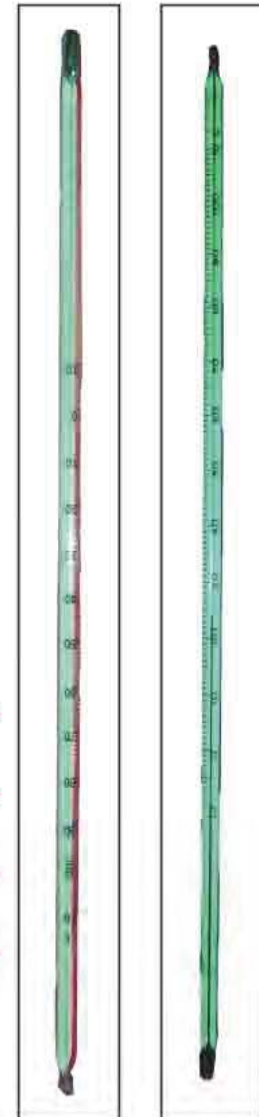

Figure 9.8 Figure 9.9



Why is mercury filled in thermometer?

Mercury is a metal in liquid state. It is expanded when heat is supplied to it. It never sticks with tube, so it can easily move in glass tube. Because of glittering of Mercury, the thermometer can be seen easily. So the temperature of the substances can be easily read.

9 ♦ Heat and Temperature



Lets measure the temperature of water with thermometer.

What is required? Domestic thermometer, two bowls, water

What to do?

- Take two bowls.
- Take cold water in one bowls.
- Take hot water in the bowls.
- Place the thermometer in cold water so that mercury part immerses in it.
- Now observe mercury in the thermometer and measure temperature. At which digit the mercury in the thermometer becomes steady?

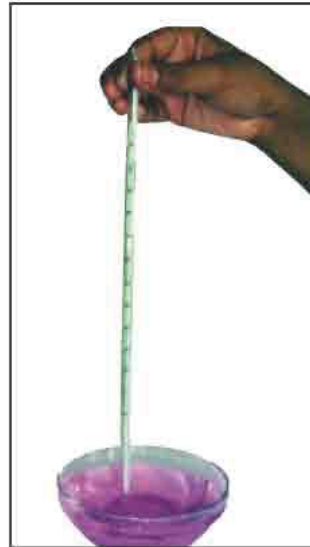

Figure 9.10



Figure 9.11

- Now place the thermometer in hot water so that mercury part immerses in water.
- Observe mercury in the thermometer and take measurement. At which digit mercury in thermometer becomes steady?

- How much maximum temperature can be measured with this thermometer.



At which digit is the steady mercury column observed while observing thermometer ? why?

Doctor uses the thermometer to measure fever of patient. It is different from a normal thermometer. Let's observe it.

9 ♦ Heat and Temperature



What is required?

Clinical thermometer

Domestic thermometer



Figure 9.12

What to do?

- Write the differences, by observing the clinical and the domestic thermometer in the table.

Clinical thermometer	Domestic thermometer
1. _____	1. _____
2. _____	2. _____
3. _____	3. _____



Figure 9.13



Figure 9.14



°C = Celsius

°F = Fahrenheit

How to convert Celsius in Fahrenheit?

$$^{\circ}\text{F} = \frac{9^{\circ}\text{C} + 160}{5} \quad \text{or} \quad ^{\circ}\text{F} = 1.8^{\circ}\text{C} + 32$$

How to convert Fahrenheit to Celsius?

$$^{\circ}\text{C} = \frac{5^{\circ}\text{F} - 160}{9} \quad \text{or} \quad ^{\circ}\text{C} = \frac{^{\circ}\text{F} - 32}{1.8}$$

9 ♦ Heat and Temperature



What is required? Clinical Thermometer

What to do?

- Measure the temperature of bodies of your five friends in your class room.
- While measuring temperature of other friend, clean the mercury containing part with cotton and give slow thrust to the thermometer.



Figure 9.15

No.	Name of friend	Temperature (Celsius)	Temperature (Fahrenheit)
1			
2			
3			
4			
5			



Which precautions should be taken while measuring body temperature with clinical thermometer?

Why does mercury become steady after some time while measuring body temperature?

9 ♦ Heat and Temperature

Why does mercury not move in downward direction after measuring body temperature by clinical a thermometer?



Normally, the body temperature of healthy person is 37°C i.e. (98.6°F)



1. Why is light thrust given to clinical thermometer before using it?
2. Can we measure the temperature of boiling water with the help of clinical thermometer ? Why?

Different types of thermometer :



Figure 9.16 Digital Thermometer



Figure 9.17
Digital Clinical Thermometer



Figure 9.18
Thermometer which is placed on forehead

We get information about temperature of different places from T.V., Radio, or news papers. Let's do activity to know the temperature in the surroundings of us.

9 ♦ Heat and Temperature



What is required ? Domestic thermometer

What to do?

- Hang domestic thermometer in the class room and note temperature in the given table below :

TIME TABLE				
Day	Morning 11.30	Noon 2.30	Noon 4.30	Average temperature of the day
Monday				
Tuesday				
Wednesday				
Thursday				
Friday				
Saturday				

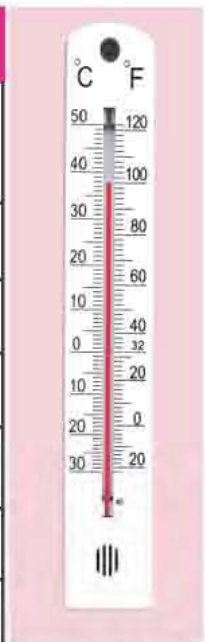

Figure 9.19
Thermometer



Average temperature of which day is more?

Temperature of which day at which time is more?

Average temperature of which day is less?

9 ♦ Heat and Temperature

By studying above table, prepare the graph of average temperature

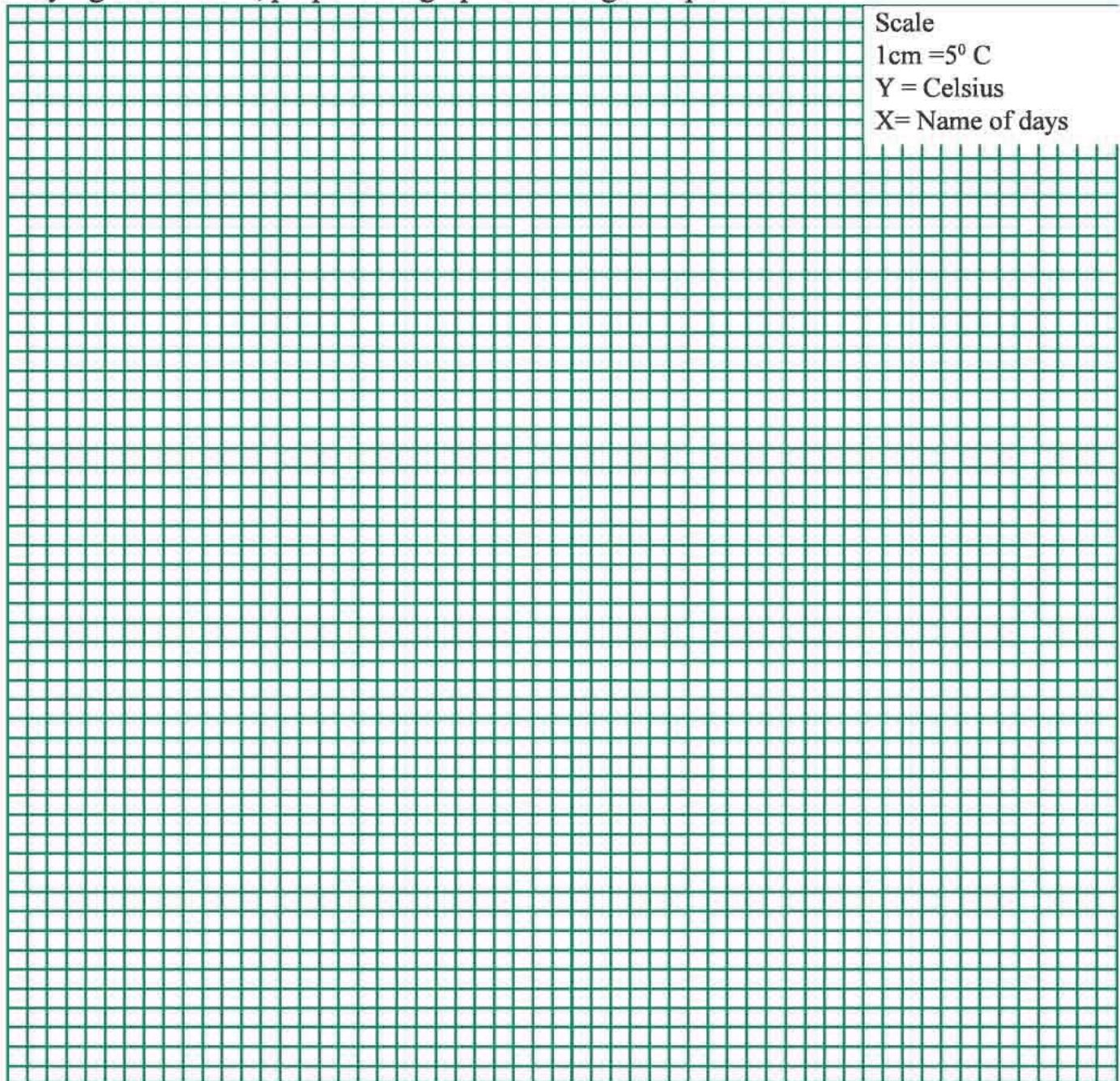

Figure 9.20

When liquid substances is heated, it converts into vapour. The chang in the form of substance takes place at definite temperature.



What is required? a domestic thermometer, a boal a pan, Ice cubes, stand, spirit lamp

What to do?

- Take a bowl place with ice cubes in it.
- Adjust thermometer so that the mercury part of it is in contact with ice.

9 ♦ Heat and Temperature

- Arrange apparatus as shown in figure. Measure temperature using thermometer..... $^{\circ}\text{C}$
- Now, heat the bowl and continuously measure temperature. When ice is in bowl the temperature is $^{\circ}\text{C}$
- Till ice is present in bowl the temperature is not increasing on supplying heat. Means this that temperature remains constant. At 0°C temperature ice is converted in to water. That constant temperature is called melting point of ice.



Figure 9.21

The constant temperature at which solid substance is converted in to liquid form is called melting point of that substance.

- After conversion of ice in water on supplying heat to bowl, temperature of water increases. After sometime, water is converted in vapour. Then even you supply heat, temperature remains constant. $^{\circ}\text{C}$. This constant temperature is called boiling point of water.

The constant temperature at which liquid is converted in to vapour is called boiling point of that substances.



Name of substance	Meting point	Boiling point
Ice	0°C .	100°C
Mercury	-39°C	357°C
Zinc	419°C	907°C
Copper	184°C	562°C
Aluminum	660°C	2467°C
Gold (Aurum)	1065°C	2807°C
Iron (Ferum)	1535°C	2750°C

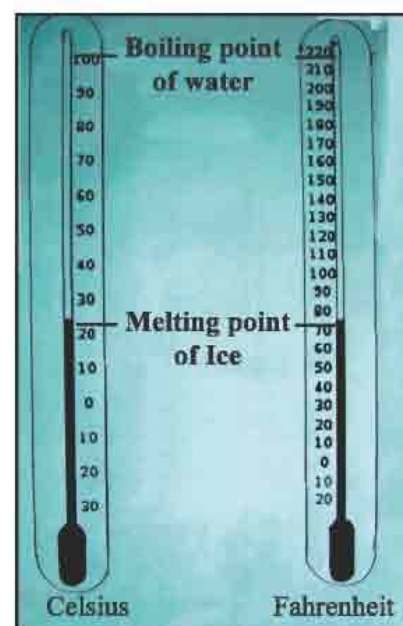

Figure 9.22

9 ♦ Heat and Temperature

For different substances melting and boiling points are different. It is used to make silver ornaments, to get petroleum products, to make ice cream, to get distilled water etc. Discuss and note the other uses.



Difference between evaporation and boiling :

1. Evaporation takes place due to vapour formed at the surface of liquid. Boiling takes place due to vapour through out the liquid inside it.
2. Vaporization occurs at any temperature. Boiling occurs at specific temperature.



Q.1 The hot water taken for bath becomes cold after some time. Why this happens?

Q.2 Can temperature of ice cream be judged by touching it ? why ?

Q.3 Measure temperature by clinical thermometer by placing it in ice cream cup. Can we get proper temperature? why?

Q.4 If there is no wedge in clinical thermometer, what happens?

Q.5 Do activity :

Take a cup and a bowl. Fill water in it. Put both in a refrigerator. In which vessel does water become cold quickly ? why?

Q.6 Visit the doctor and get following information :

- (1) Which device is used to measure fever of patient? why?
- (2) Which type of thermometer does the doctor have?

9 ♦ Heat and Temperature

- (3) What is the body temperature of healthy person?
- (4) When can be said that the patient has fever?
- (5) Note the body temperature of a patient when you visit.

Name of patient :

Temperature : _____ °C _____ °F

Q.7 Draw figure of Domestic thermometer.



10

Air Pollution

Raju and Riaz are fast friends. Raju lived in a village while Riaz lived in a city. Raju went to Riaz's house in the city during Vacation. Both friends went for a walk in the evening. Raju saw many vehicles running on the road. Smoke was coming out of industrial chimnies. Raju felt the heat. He felt irritation in his eyes and nose. When they moved further Raju started sneezing and suffocating suddenly. Do you know, why did it so happen to Raju?

There are different gases and microorganisms in the atmosphere. The harmful changes that are burnal to environment are known as pollution. The factors responsible to spread pollution are known as pollutants. Pollutant may be in solid, liquid or gaseous form. Out of these, the gaseous pollutants are more in proportion in the atmosphere. Do you know what are the reasons which spread air pollution? Let us see.



Figure 10.1

- Write reasons for air pollution on basis of the above picture

10

Air Pollution

Raju and Riaz are fast friends. Raju lived in a village while Riaz lived in a city. Raju went to Riaz's house in the city during Vacation. Both friends went for a walk in the evening. Raju saw many vehicles running on the road. Smoke was coming out of industrial chimnies. Raju felt the heat. He felt irritation in his eyes and nose. When they moved further Raju started sneezing and suffocating suddenly. Do you know, why did it so happen to Raju?

There are different gases and microorganisms in the atmosphere. The harmful changes that are burnal to environment are known as pollution. The factors responsible to spread pollution are known as pollutants. Pollutant may be in solid, liquid or gaseous form. Out of these, the gaseous pollutants are more in proportion in the atmosphere. Do you know what are the reasons which spread air pollution? Let us see.



Figure 10.1

- Write reasons for air pollution on basis of the above picture

- **Smoke exhausting vehicles :**

Smoke exhausted by scooters, trucks, motor cars etc. spreads pollution in air. Now a days, the upper layer of the air also gets polluted because of the poisonous gases produced from the fuels used for jet planes, rockets and missiles



Figure 10.2



In the sky, we see a big strap behind some aero planes, what is it?

- **Smoke coming out of industries :**

The pollution of air has reached to dangerous level because of industries. Because of use of chemical substances in the industries, carbon particles and poisonous gasses like carbon monoxide (CO) sulphur dioxide and hydrogen sulphide (H₂S) are produced and mix with the air, and so they pollute the air. In addition, woods and coal are used as fuel in many industries. Because of this, the carbon dioxide (CO₂) and carbon monoxide (CO) are produced and they spread pollution of air.



Figure 10.3

Collect the book "Industries of district" from the school library and discuss the air pollution.

10 ♦ Air Pollution

- **Deterioration of substance :**

When the vegetables, fruits, foods excreta of animals, dead bodies of animals lie for a long time, get deteriorated and gases like Ammonia (NH_3) Carbon dioxide (CO_2) and hydrogen sulphide (H_2S) with very foul smell as well as the microorganisms are produced and they spread pollution in air.

- **Dust Particles :**

The dust particles, carbon particles, pollen grains, hair, wool and fine threads of cotton etc. mix in the air and pollute the air. In addition, the flying particles present at the place like industries producing cement and lime and pottery (ceramic) industries, coal mines mix in the air and spreads pollution.

- **Radiation :**

In the present time, atomic energy is used in different works and so radioactive pollution has increased. Harmful (Hazardous) radiations spread in the atmosphere because of the experiments of armaments like atom bomb. There is a possibility of spreading of this type of pollution from the waste produced by atomic electric power and atomic reactors.



Figure 10.4



Figure 10.5



Figure 10.6



Discuss the incident happened at Fukushima reactor, Japan with your teacher and note down.

10 ♦ Air Pollution

Collect the book "problems of district" and collect more information regarding pollution and its effects

- **Exhalation of living beings :**



Which type of gas is exhaled by living beings?



Why do we feel suffocation in the closed hall where many people gather?



Why do doctors and nurses cover their mouth and nose with masks?

10 ♦ Air Pollution

Thus, living beings exhale carbon dioxide during their respiration. Hence the proportion of carbon dioxide increases in the atmosphere. Then Raju and Riaz saw people moving on the road. They had tied handkerchieves on their face. Raju and Riaz also tied handkerchief on nose.



Why do Raju and Riaz cover their face with handkerchieves?

• **Effects of Air pollution?**

Life is not possible without air, but harmful gases produce many harmful effects like,

- Irritation in eyes, nose and throat
- Sneezing
- Difficulty in breathing
- Cancer of trachea and lungs
- Infertility, disease of skin and eyes.
- Death of animals
- Decrease in growth of leaves, flowers and fruits of plants.
- Green house effect
- Acid Rain

- Carbon cycle :**

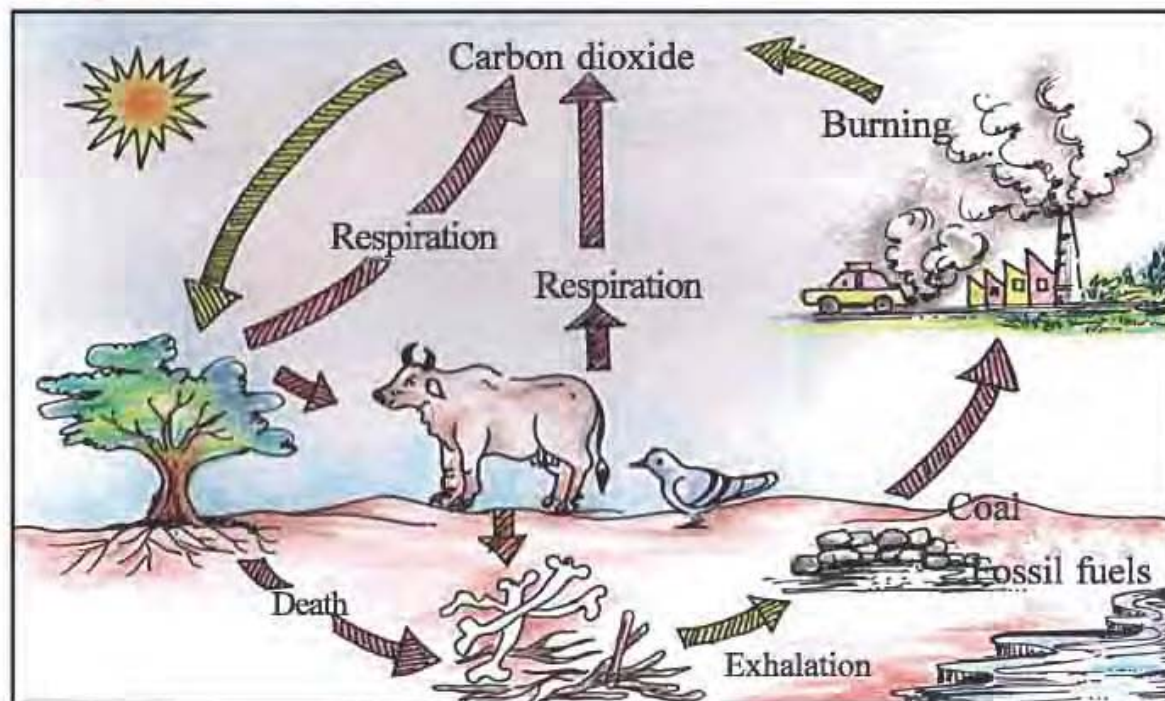

Figure 10.7

The proportion of CO_2 is 0.04% in the atmosphere. CO_2 is released by organisms during exhalation. Plants absorb this carbon dioxide for photosynthesis. When animals feed upon plants or products of plants, carbon dioxide enters into their bodies. CO_2 is liberated into the air and water during respiration and by the burning of their dead bodies. The burning of coal and fossil fuels also adds carbon dioxide in the atmosphere. Thus the great carbon cycle of nature goes on continuously.

Carbon dioxide possesses the property to absorb heat. When solar radiation enters our atmosphere, our soil absorbs some radiation and convert those radiation to heat, rest of the radiation is reflected back but that is absorbed by atmosphere carbon dioxide. Thus it maintains the atmospheric temperature. But due to increased CO_2 temperature of our earth is also increased. This effect is known as Green House Effect.

Due to effect of green house :

Melting of polar ice caps results into increased sea level which leads the sinking of cities and villages situated on sea shore.

Evaporation of water due to heat will increase 5% to 7% of total rainfall. But this will imbalance the distribution of rain and will result in to flood and draught at different places. We have suffered this situation during last few years frequently.

10 ♦ Air Pollution

Due to the increased temperature, days and nights of summer and winter has lost their naturality. You many feel two-three seasons at a time. We have also noticed the increased numbers of days of summer and also intensity of summer.

- **Acid rain and its effects :**

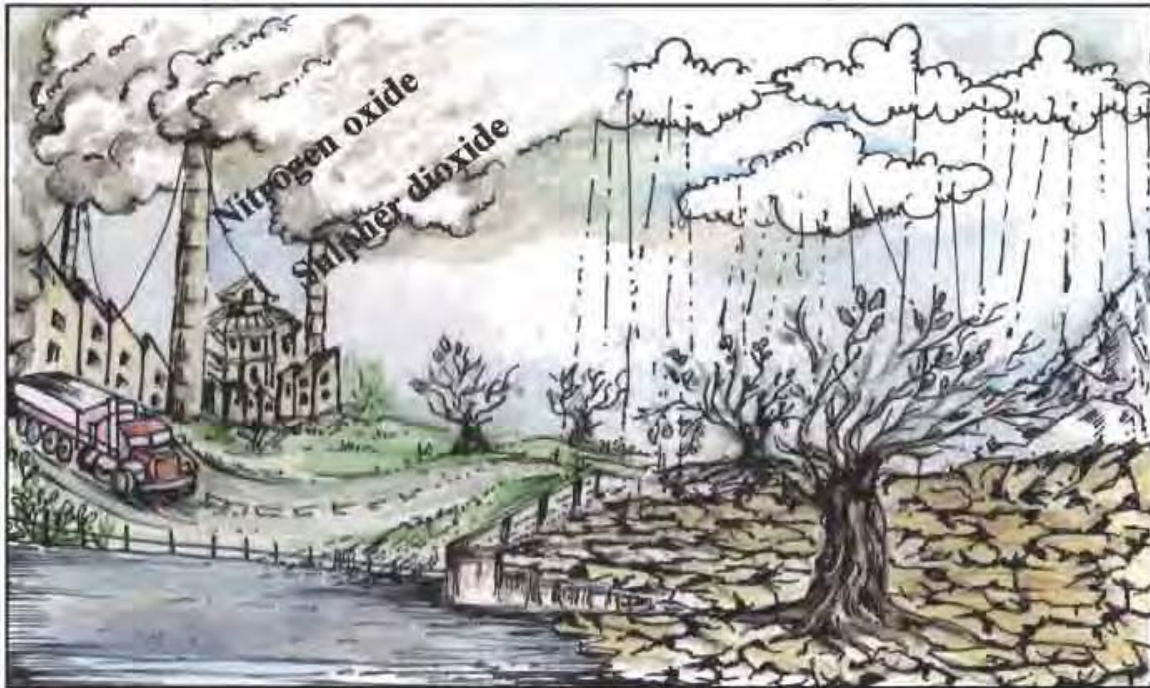

Figure 10.8

When the moisture in the atmosphere increases, the dry particles in the form of acidic gases like sulphur dioxide and nitrogen oxide etc. dissolve in the moisture and produce sulphuric acid (H_2SO_4) and nitric acid (HNO_3) respectively, it falls on the land with the rain water and it is called acid rain, which effects,

- Deforestation
- Decrease in the soil nutrients and fertile lands become barren.
- Big monumental buildings get damaged



Do aquatic animals and plants get any effects of acid rain ? How? Note down.

10 ♦ Air Pollution

Raju and Riaz came back to home and get asleep Riaz saw a devil in his dream. He introduced him as air pollution. He said that he will destroy the world by increasing the temperature. He said, "I will create a dangerous situation for life with the help of flood." The devil started squazing the earth. Riaz frightened and he lost his sleep. He told Raju about his dream and draw the picture of his dream.



Figure 10.9

- **Both friends started thinking how can the world be saved against the devil like pollution? Write five sentences looking this picture.**

- **Measures to stop air pollution**

Natural factors

1. **Plants** : Plants absorb carbon dioxide (CO_2) and release oxygen (O_2) during the process of photosynthesis. It reduces the air pollution
2. **Rain**: When it rains, the gases like carbon dioxide of the air dissolve in water. Also, the dust particles in the air and certain impurities are being washed out with rain water and so the air becomes pure.
3. **Wind** : Because of the wind, polluted air is being pushed far away and it is replaced by pure air, The proportion of polluted air decreases due to this.

10 ♦ Air Pollution

4. **Sunlight :** The microorganisms present in the air are killed ((destroyed) by the heat of the sun and so the air becomes pure



Visit a nearby petrol pump and discuss the following questions.

Q.1 What is PUC?

Q.2 Why is PUC required?

Q.3 Which fuel is advisable diesel, petrol, or CNG ? Why?

Q.4 What type of care should be taken of vehicles to reduce pollution?

10 ♦ Air Pollution

Following remedies can be tried and air pollution must be stopped :

- More and more plants should be grown and should be protected
- PUC of vehicles should be obtained.
- Pure fuel should be used for vehicles.
- For cooking biogas, cooking gas (LPG) and solar energy should be used instead of wood, coal or animal dung.
- Use of solar equipments should be promoted.
- More and more biogas plants should be established.
- Efficient and less pollution producing stoves should be used.
- Rules should be followed strictly to control pollutants released by factories and mills.
- Proper design of vehicles should be invented for the complete use of fuel and release of less fumes.



What is required? PVC pipe with 2 inch diameter, 4 elbows of same size, two corks,

What to do?

- Arrange the pieces of pipe as shown in the figure.
- Make two holes in the middle pipe and shut them with the help of corks.
- Fill the pipe with water from the upper hole.
- Put this structure above the stove from where the smoke arises. Here the carbon particles will remain in the water and purified smoke will come upward.
- Change water at certain intervals.
- You can make smokeless stove in this way.

Raju and Riaz discussed about control of pollution. They decided to grow trees in their school and than Raju went back to his village.

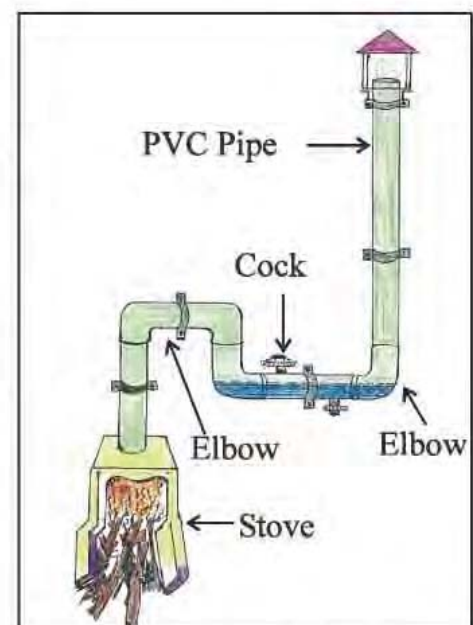

Figure 10.10

10 ♦ Air Pollution



PPM (Parts Per Million) is a unit to measure air pollution.

Pollution control board is operative at the state level as well as at the national level to observe the rules regarding pollution. Gujarat pollution control board is situated at Environment Bhavan, Sector 10 A Gandhinagar.



Q.1 How do the trees help us to control air pollution?

Q.2 Why should factories and mills be built away from residential area?

Q.3 What will you do to reduce air pollution ? Note down.



11

Our Solar System

We are able to observe planets with naked eye and can distinguish the stars different from planets. Let us play a game to have a space walk in our solar system.

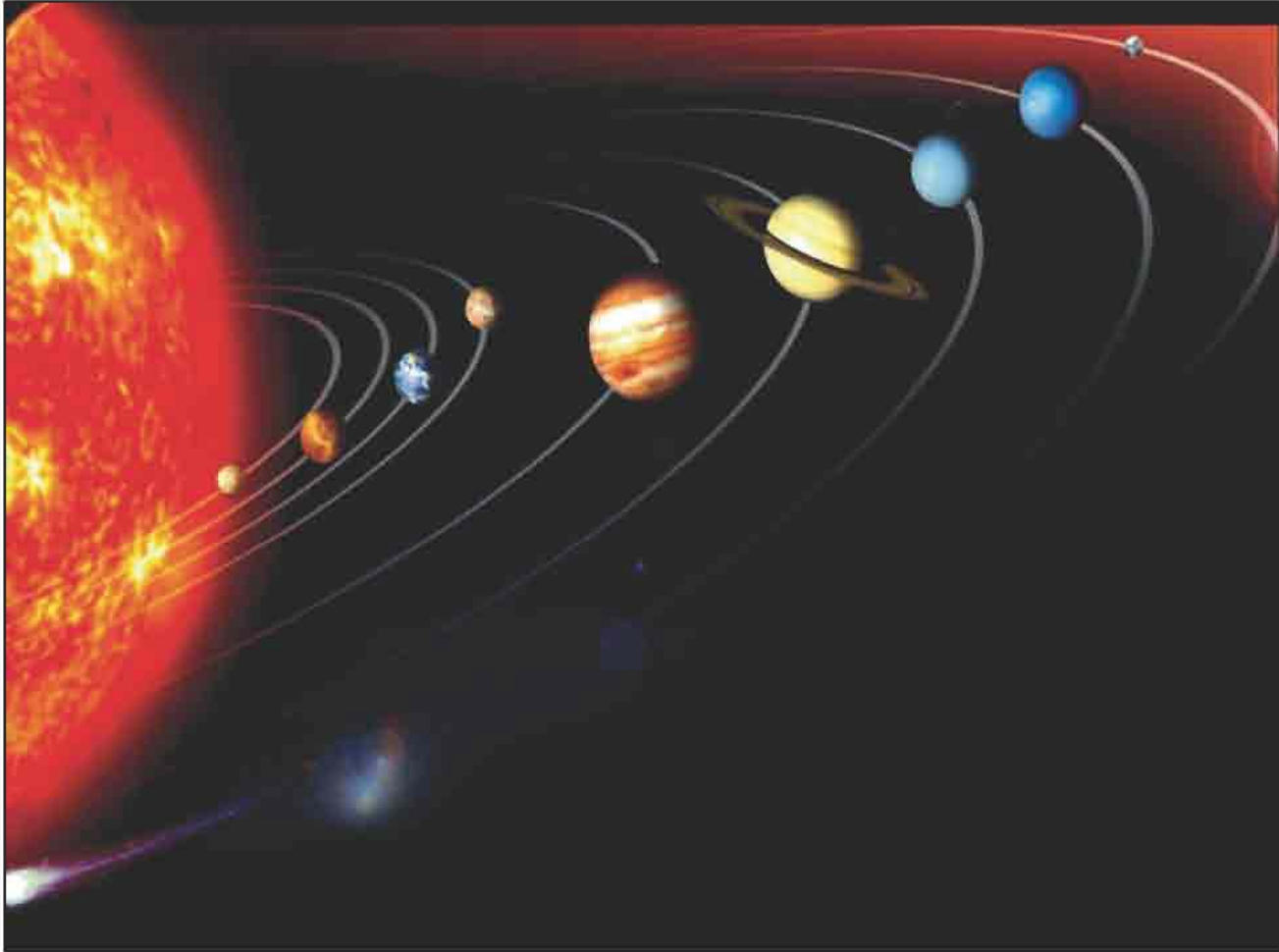

Figure 11.1



What is required? Nine different big cards written with the name of nine planets on them, which can give brief details, thread

What to do?

- Select ten (volunteers) students and request them to stand at the orbital position of Sun, Mercury, Venus, Earth, Mars, Jupiter, Saturn, Uranus, Neptune and Pluto

11 ♦ Our Solar System

- Request the student named Sun at the centre and others at different orbital positions accordingly around him.
- Tell them to spin along with orbital motion.
- Give the card of introduction to each student according to their planetary identity. Thus Sun and others will give their introductions (on the cards).

Sun : My name is Sun. I am a star. There are planets and satellites, meteorites, comets in my family.

- Each member of my family orbits around myself. It is orbital motion.
- Each member rotates around their own axis, it is known as spinning motion
- Out of nine planets family members, you can observe five namely Mercury, Venues, Mare, Jupiter and Saturn by naked eye from the Earth. To see other telescope is required. I call the members of my family to talk with you, one by one, talk with them.

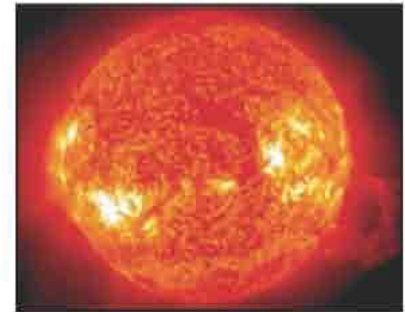

Figure 11.2

Mercury : I am nearest planet to the sun

- I have no atmosphere
- The nights and days are longer here.
- My spinning motion is very slow.

Venus : I am the brightest planet in my solar family.

- You can observe me in the east before the sunrise and in the west after sunset from the Earth.
- I have atmosphere.
- Water is observed in gaseous form here.
- People call me morning star on the Earth.



Figure 11.3



Figure 11.4

11 ♦ Our Solar System

Earth : It is rare that I am unknown to any body. I am also a planet of the solar system.

- I am such a planet where life exists.
- Oxygen, Nitrogen, Hydrogen, Carbon dioxide and other gases exist in my atmosphere.
- Water, mainly in liquid form is observed here.
- The planets which have smaller orbits (of motion) but my orbits are known as internal planets. Mercury and Venus are internal planets. The planets having bigger orbits than that of mine are known as external planets. Mars, Jupiter, Saturn, Uranus, Neptune and Pluto are external planets.



Figure 11.5

Mars : I am a red coloured planet

- I possess atmosphere similar to Earth but it is less dense.
- There is large difference observed in temperature at night and during day time here.



Figure 11.6

Jupiter : I have highest volume among all the planets of solar system.

- I am 1317 times bigger than the Earth.
- The gravitational force observed here is the highest in comparison to that of on the other planets.
- My diameter is 11 times more than that of the Earth.
- My mass is 318 times than that of the Earth.
- My mass is 2.5 times higher than total mass of all the remaining planets.



Figure 11.7

Saturn : I am the most beautiful planet.

- My colour is yellowish.
- There are blue iced rings around me. See Fig.
- I have volume size next to Jupiter.



Figure 11.8

11 ♦ Our Solar System



Figure 11.9

Uranus

- There are thin rings around myself.
- There is presence of hydrogen and ammonia gases.

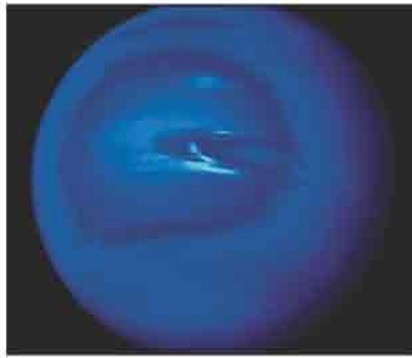

Figure 11.10

Neptune

- There are very thin rings around myself.
- There exists hydrogen and Helium gas.



Figure 11.11

Pluto

- I am the farthest family member of solar system.
- There is almost darkness here.



Think what would happen if the Earth was at a higher or lower distance from the Sun than that of what it is today.

Study the following table

	Internal Planets		Our plante	External planets					
	1	2	3	4	5	6	7	8	9
	Mercury	Venus	Earth	Mars	Jupiter	Saturn	Uranus	Neptune	Pluto
Sun	Nearest to sun	the brightest of all	Have life	Red colour	Biggest of all	Beautiful	Thin rings around it	Very thin rings around it	Dark planet

In addition to those characteristics, there are some of the natural satellites and some planets.

Satellites

- As planets revolve around the sun, similarly some celestial bodies orbit around planets, they are called natural satellites.
- The way the planets spin their own axis of rotation, some of the satellites do have spin motion, They revolve around the planets also. They are not self shining objects like stars.



Figure 11.12

11 ♦ Our Solar System

- Except Venus and Mercury, all planets have natural satellites.
- Moon is natural satellite of the earth.

Meteorites :

- The big rocks (many of them are bigger than that of our moon in size) which failed to become planet at the time of formation of solar system, and which do orbit around the sun, are known as meteorites.
- There is a big belt of such meteorites between the orbits of Mars and Jupiter. They also revolve around the Sun.



Figure 11.13

Comets :

- Due to appearance of a tail, these are also known as “Tailed stars” They do not have tails in reality.
- Comets are not self shined objects, but their shining is due to reflection of the sun light from them (comets).
- Majority of comets are of celestial objects detached from a big cloud nearing solar system known as “Cloud of Urt”.



Figure 11.14



A comet named Halley has a periodicity of 76 yrs.

The photograph of Halley’s comet shown in fig. 11.14 was clicked in the year 1910. This comet was seen again in 1986.

The astronomical unit to measure the distance between celestial oabjects is ‘light year’. ‘Light year’ is a distance travelled by light in one year.

$$1 \text{ Light year} = 9.46 \times 10^{12} \text{ Kilometer}$$

As the distances between celestial objects are too large, a measuring unit like km is very small and hence the astronomical unit like light year is used for the measurement.

11 ♦ Our Solar System

Shooting starts :

These are basically not the stars but celestial objects. When any object with very high speed approaches very near to the atmosphere of earth, they get exhausted and start burning while passing through the atmosphere and turn to pieces during motion, due to the burning of the object and due to very high friction these objects shine and appear like shooting stars.

Many of such objects do not completely burn out to ashes but some of the pieces of such objects do reach upto the surface of the earth. These are known as shooting stones.



Figure 11.16



Figure 11.17

**Q.1 Write the names of the objects having the following characteristic :**

- (1) Nearest planet in the solar system : _____
- (2) The biggest planet in the solar system : _____
- (3) The most beautiful planet in the solar system _____
- (4) Satellite of the earth : _____
- (5) Darkest planet of the solar system : _____

Q.2 Prepare a collection book by collecting articles from periodicals, newspapers books, etc. about the information of celestial activities taking place periodically.

12**Food Chain**

You may have seen many animals, birds and, insects. Note down the food habit of the following animals, birds or insects.

Name	Food (what they eat?)
1. Snake	
2. Peacock	
3. Deer	
4. Tiger	
5. Ant	
6. Fish	
7. Frog	
8. Duck	
9. Spider	
10. Lizard	

Each organism requires food to survive. The same way, there are many things which can not be taken by us as food even though those things are necessary for the survival. Discuss it and note down them in the following figure.

12 ♦ Food Chain

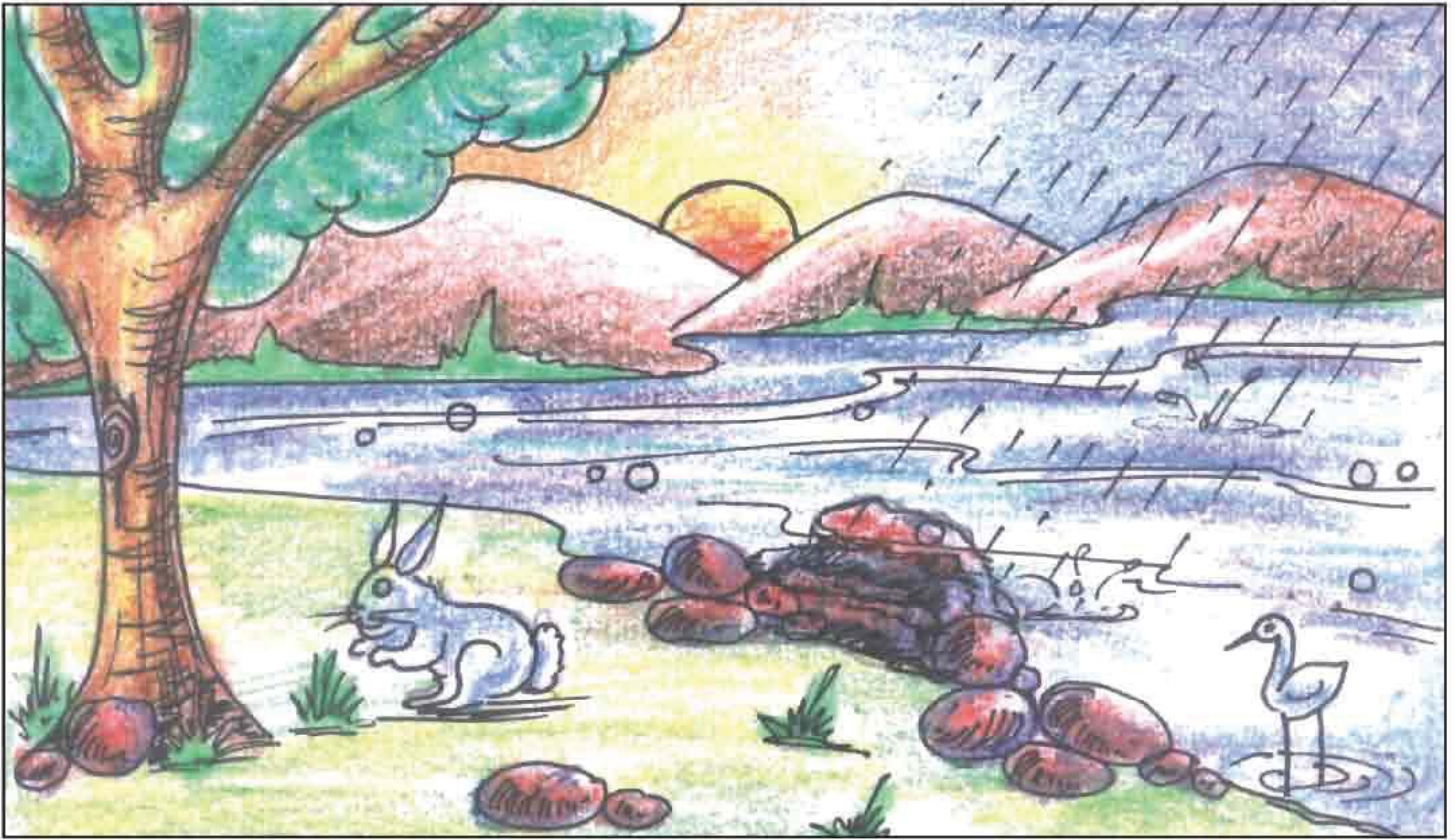

Figure 12.1

Thus, organisms are dependent on other organisms or many other non living things. Thus environment consists of two types of components.

1. **Living components (Biotic components) :** Those components which are biotic beings are called living components, eg. Animals, Birds, Insects, Microorganisms.
2. **Non living components (Abiotic components) :** components of the environment which are not living beings are known as non living components eg. light water, mountain

Above said living and abiotic components are interconnected and have their own importance

- Milk of animals like cow buffalo and goat is useful.
- All the trees are important as food or in any other way.
- Abiotic factors like air, light, energy, temperature, minerals etc are very important.

12 ♦ Food Chain

- Plants produce their food in presence of sunlight and we use those plants as our food.
- Air and water are our basic requirements.
- We grow food on the land and we use that as food.
- We feel uneasiness when there is increase or decrease in temperature.
- Mineral salts are important for nutrition



What will happen, if the sun does not appear for a year?

You may have understood the importance of biotic and abiotic components.

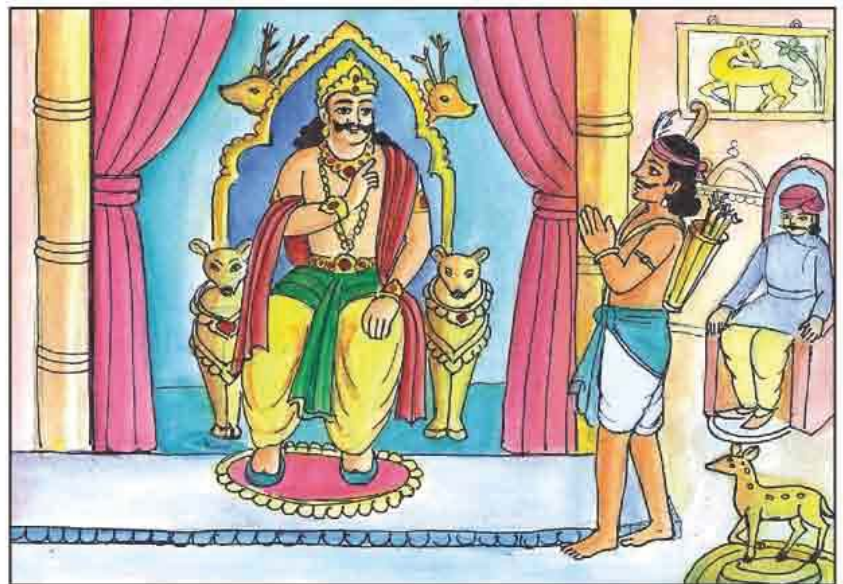

Figure 12.2

12 ♦ Food Chain

There was a king. He liked deer very much. Counting of deer population of his state was conducted once. Counting showed that there were totally 1000 deer in his state.

The king ordered “No body will hunt the deer. I want to increase number of deer, If some one is found hunting deer he will be sentenced to death”.

The counting was held again after five years, but surprisingly the total number of deer remained the same.



How has this happend?

When the king investigated, he found that like animals tiger, lion etc killed the deer for their food. Looking to that, the king ordered to trap all those animals which generally killed the deer and to send them out of his state. He also told to take care that no animal should come back to the forest again.

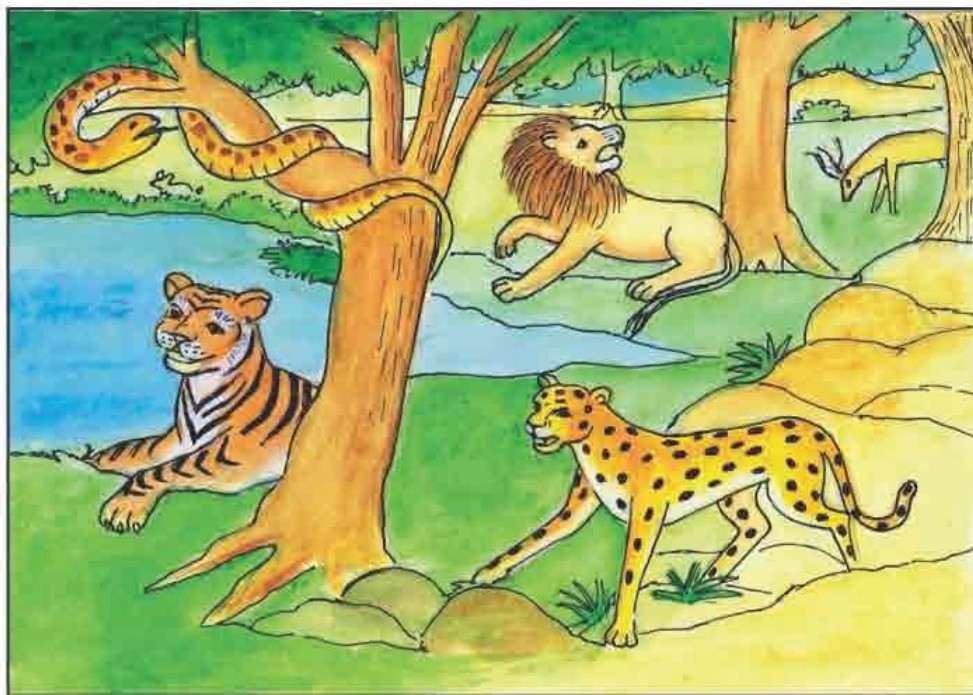

Figure 12.1

12 ♦ Food Chain

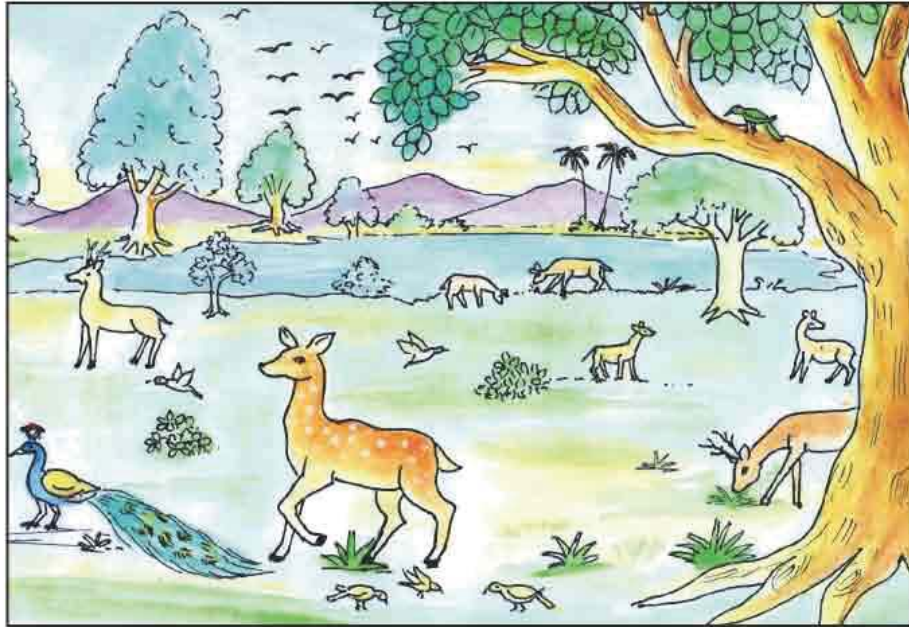

Figure 12.1



Number of deer got decreased after 3 years of obedience of the order. Why has this happened?

On investing, he found that initially deer got enough food but as soon as their number started to increase, they found difficulties in getting food and it resulted into decrease of their number. Then the king realized his mistake and solved it. Thus, each organism is related to each other for food directly or indirectly and small or big are makes importance.

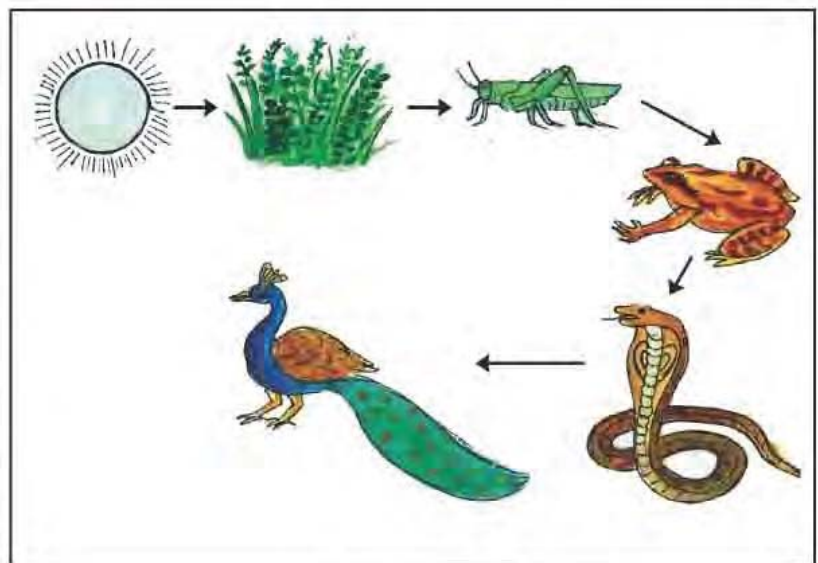

Figure 12.5

12 ♦ Food Chain

From the figure shows that organisms are dependent on each other for their food and thus they form a food chain. We all know that the sun is the main source of energy. Green plants synthesize their own food by the process of photosynthesis in presence of sunlight. Other organisms make use of plants as food. Thus energy of plants is obtained by animals. These animals are eaten by another large animals. In this way in nature organisms are dependent on each other for food. The structure of food chain is formed on the basis of who eats whom.

Observe the following picture :

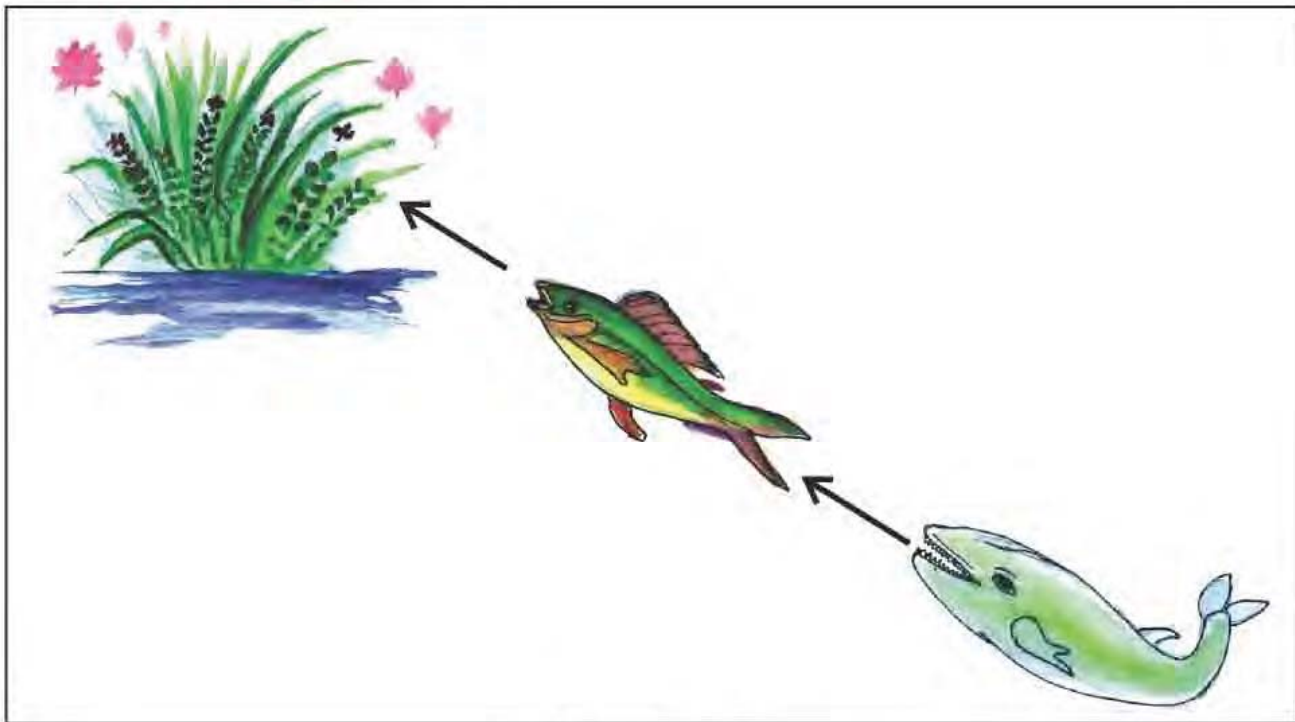

Figure 12.6

Think of any other food chain of this kind and note it down.

12 ♦ Food Chain

Thus, many such food chains are found in the living world and in this way, they get nutrition. In most of the food chains, the sun and plants play an important role. Understand the following pyramid.

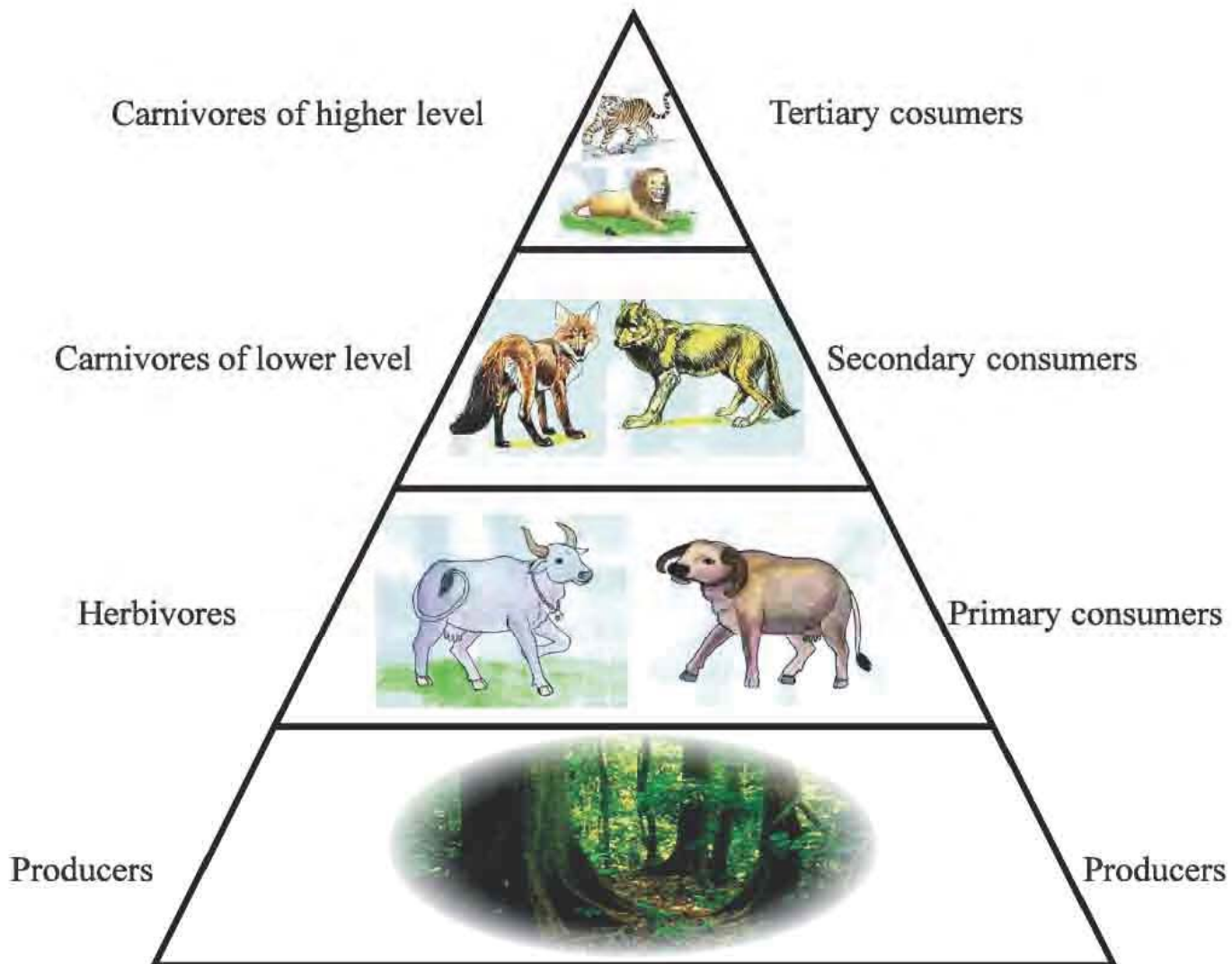

Figure 12.7

- Green plants synthesize their own food by the process of photosynthesis in presence of sunlight. Thus plants utilize sunlight directly. Hence plants are known as producers.
- Herbivores make use of plants as food and get energy.
- Thus energy flows in secondary and tertiary consumers respectively. Let us play a game.

Collect the book "Animal world" from your school library and get food habit of animals and discuss that information regarding food chain.

12 ♦ Food Chain



What is required? Cards of names of different living and non living things, long thread.

What to do?

- Hang one card each around the neck of every student. Take a ball of thread in your hands.
- Hold the end of the thread and throw the ball of thread towards the pupil who has hung the card of the thing organism which you think of your requirement.
- The student who has the ball will throw the ball in the same way. Thus a reticulate structure will be formed of the thread which can be called the food web.

Thus, each food chain is connected to one another and forms food web. In short, the food chain and the food web are important for natural balance. Hence it is our moral duty to conserve each and every individual living as well as non living things. To understand more, discuss on the bases of the picture beside.

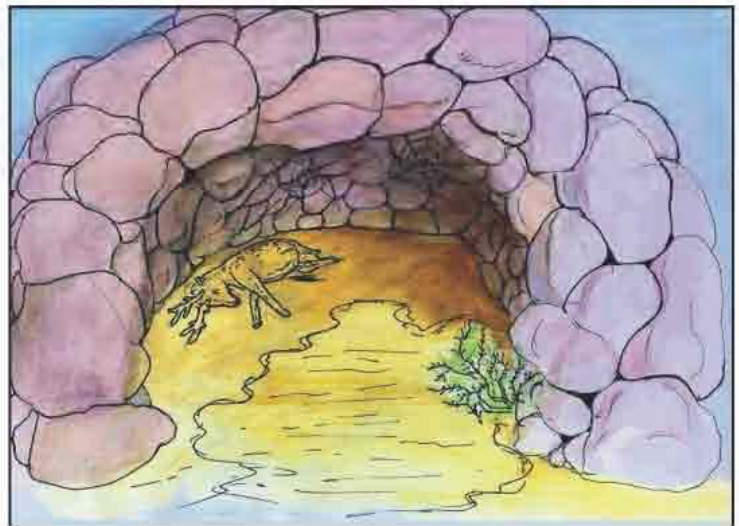

Figure 12.8



A spider web is found in this cave. Which other living and non living components may be found in this cave? Think and note down here.

12 ♦ Food Chain



Fill up the following information observing your favorite place.

Name of place

Which non living things are found at that place?

Which insects are there?

Which animals are there?

Whether dirtiness is there? which?

Note down the names of useless things.

Did you find any kind of pollution? (Air, water, soil or any other of pollution) Note down.

12 ♦ Food Chain

Now, you may have understood that different organisms live at different places and get their nutrition. But due to some reasons, many organisms have been destroyed are on the threshold to be extinct. Prepare a list of organisms which you do not find at present but were found earlier.



You must be doing the activities like (Eco club) in your village or in your school to conserve environment and to stop disappearance of such organisms. Note down such activities.

12 ♦ Food Chain



- Q.1** Write names and importance of any five biotic components of the environment.
- Q.2** Note down names of any five abiotic components of the environment and write their importance.
- Q.3** Think of any one food chain and write down.
- Q.4** If there is less amount of water and thorny trees are found, which type of animals can be found there?

Animals : _____

Birds : _____

Insects : _____

Plants : _____

- Q.5** Prepare a list of plants, animals and abiotic components found in your village and also try to find relation between them.



13

Environmental Equilibrium

We know about the components of the environment. The environment comprises of living world and nonliving world. The environment means all those living and non living factors affecting the life and growth of living beings. You have the knowledge of it. Let us note down them.



Biotic components of the environment

Abiotic components of the Environment

Short note on importance of the biotic and abiotic components of the environment

13 ♦ Environmental Equilibrium

You played a game in the unit of food chain to understand the importance of the factors effecting the environment. Hence you must know the importance of the factors in the maintenance of environmental equilibrium



Now tell, when does the environmental equilibrium get disturbed?

Some organism can not adopt to the changing conditions developed due to the imbalance in the biotic and abiotic factors. Hence, their existence threatened and results in to extinction of some species.



Which animals are found rarely or in small number around you?

Those living species are called endangered species which loses their number gradually.

Tiger is our national animal. It is powerful and carnivores animal. It gets its food by hunting herbivores and small carnivores.



Figure -13.1

13 ♦ Environmental Equilibrium

Hence number of animals get restricted and their equilibrium can be maintained.

- Skin, claws and other organs of the tiger are used for human entertainment. Hence it is hunted.
- The existence of tiger is found in danger due to some reasons.
- This species can be said extinct from Gujarat.
- Lion is a powerful and carnivores animal. It is declared the state animal of Gujarat state. It hunts wild animals to get its prey. Hence equilibrium of other animals can be maintained. The lion is known as the king of forest. It is fortune to watch the king of the forest moving freely in the forest. Unfortunately their numbers is decreasing.



Figure -13.2



Prepare a list of such endangered animals after discussing with your teacher.

Reasons for the extinction of such animals :

- Due to deforestation their homes (habitat) are lost and number of their prey reduces.
- Hunted by human beings.
- Inconvenience to their matting and to maintain their health created due to noise pollution and air pollution.

13 ♦ Environmental Equilibrium



What can be done to protect and nurture such animals?

Get information, regarding breeding of endangered animals, birds and sanctuaries developed from the book "Specialty of District".



The Asiatic lion is found only in the Geer forest in Gujarat which is one of the eight endangered mammals. While wild ass is found in the Rann of Kachh. A tiger santury is located in Sundarvan, West Bengal.

Albino (White) tiger is found in Reva, MP, After extinction of the tiger in Gujarat, Elephant, Chittah, Kasturi mrug, black buck, Ant eater, desert fox, big Indian squirrel, flying big squirrel, python etc are endangered. Chittah is found to be extinct from India.

Giraffe is the tallest mammal on land, which is found in the Africa. There are total 4 sanctuaries and 22 national parks in Gujarat.

Different kinds of birds are found in the environment. They are strongly bounded to our life.

- Fill up the following table on basis of your surrounding environment.

Birds found in highest number	Birds found in less number or rare	Birds never found

13 ♦ Environmental Equilibrium

According to the list prepared by you, some birds are found in less number or found rarely.

- Let us know about such endangered bird species.

Sarus crane : Saras is the tallest bird of India. The pair of male and female of this bird remains together for life time. It is believed that when one of them gets died, the other dies in absence of the partner.

- Their food includes grains, plants, small insects, frogs, moluscans and small reptiles etc.
- Marshy lands and glassful fields are their habitat. This bird is found in the villages of Ahmedabad, Kheda and Kutch districts. The number of this bird is decreasing gradually.



Figure 13.3

Vulture :

- Vulture is a hunting bird. About 15 species of vulture are found in the world and 6 are found in Gujarat.
- Vulture generally feeds on the dead bodies of animals and thus it removes them and helping us to save our environment. Hence they are also known as sweepers.
- They are not found at one place permanently due to inconsistency of food availability. Their population is found mainly in Surat, Valasad and Dang district in South Gujarat.
- Vulture is considered endangered species.

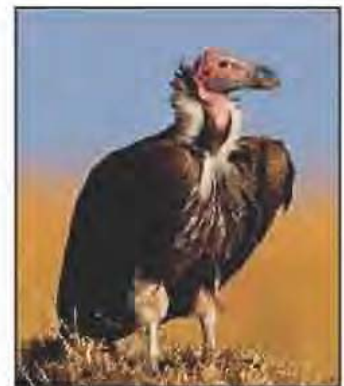

Figure 13.4

Bustard (GHORAD) :

- Bustard is found in grasslands. This bird is found frequently in the saline marshy lands in Gulf of Kuchh.
- This bird is the state bird of Rajasthan.
- Lala Ghorad Century is specially declared sanctuary in Gujarat for bustard.
- It is also declared endangered due to its decreasing number.



Figure 13.5

13 ♦ Environmental Equilibrium

Sparrow :

- Sparrow is generally found in the village regions. Hence it is known as local sparrow or village sparrow.
- They eat small insects and grains.
- They use small harmful insects to the crops as their food and hence known as friends of farmers. But their population is also decreasing rapidly.



Figure 13.6

Prepare a list of birds found on risk of extinction after discussing with your teacher.



How are the birds useful to maintain environmental equilibrium?

Reasons for the increase in the numbers extinct, endangered or threatened bird species.

Reasons :

- Habitat lost and food scarcity increases due to tree cutting
- They migrate due to noise pollution, Scarcity of water bodies and lost of natural habitat.
- Their health is lost due to industrialization as well as water, air and soil pollution.
- By eating toxic food due to the use of pesticides and chemical fertilizers used by farmers.

13 ♦ Environmental Equilibrium



Different types of Birds :

- **Beautiful birds** : Peacock, parrot, golden back wood pecker etc.
- **Sweet singing birds** : Bulbul, Cuckoo, Hill maina, Daiyak, Shama, Chuudal, lare bird
- **Birds Helpful in seed dispersal** : Vaiya, Bulbul, Chilotro, Tuktukiya, Pigeon, Hariyal etc.
- **Hunter Birds** : Owl, Kite, Vulture,
- **Birds cleaning the environment** : Vulture, Kite, Crow
- **Whistle blower birds** : Kalio koshi, Laila, Kherkhatto, tintodi, maina, bulbul, wild cock etc.

There are five bird sanctuaries in Gujarat

- The biggest aviary of India is situated at Indroda Sanctuary, Gandhinagar.
- There are total 9000 genera of birds found in the world. among them-1230 in India and 479 in Gujarat.
- Bustard is second heaviest flying bird of the world and it is on the threshold of extinction.
- Bat is a mammal, it is not a bird.
- Sense to smell is weak in birds but they have very powerful eyesight.
- Previously illness of animals was treated with a drug named Diclofenake. But when such dead bodies of animals were eaten by vultures they got died, hence, government has banned this drug.

World Wet Land Day- 21, February

World Sparrow Day – 20, March

13 ♦ Environmental Equilibrium

Many variations are found in aquatic organisms. They play valuable role to balance the environment.



Prepare a list of aquatic animals.

There may be turtle, crab, water cat, fish, crocodile like animals in your list. Water food chain get broken when existence of some aquatic animals is under threat. Some genera become extinct when such imbalance occurs. Let us have introduction of fish.

Whale Shark :

We are aware of the name 'fish' There are thousands of fishes found in the world.

- Some people do not have proper information about whale shark. It is known as whale.
- Actually whale is classified as mammal. Where as whale shark given in the picture is classified as marine fish.
- Gujarati fisherman call them Maghra
- This fish is the biggest shark of the world. Due to its huge body, it is known as whale shark.
- It takes small fishes and other small aquatic animals as its food.
- A special oil is extracted from its liver which is used to prepare some medicines.
- It is also known as Kalpmatsya as its all organs are useful.



Figure 13.7

13 ♦ Environmental Equilibrium

- Department of environment and forest of India has banned the hunting of whale shark.

Factors insecuring the existence of aquatic organisms :

- Many birds, fishes and other aquatic organism get destroyed due to petroleum pollution in oceans.
- Hunted by fishermen :



- Oil is extracted from shark liver. It is used in medicines as sharkoferol or shark capsules,
- The longest dolphin is known as “Killer Whale” or “Arko”
- Perfume material known as embergreese is produced from the intestine of a whale, generally known as sperm whale.
- Countries Earn foreign exchange by selling fish products.
- Gujarat is the first proud state of India by declaring 457.92 square km area as a sanctuary and marine national park near Jamnagar and gulf of Kuchh to protect marine animal world and their habitat.

We found that due to various reasons, existence of some species found in danger. Environment friendly, always helpful, providing shelter, and food to many organisms, such trees are our great friends. Their numbers are also decreasing rapidly. All these things are known to you.



Prepare a list of trees found rarely or in few number surrounding you

Tree found less in numla

13 ♦ Environmental Equilibrium

Tree which are not at all found.

It may happen that some of you may not have heard the name of mangrove.
We will know some thing about Mangrove today.

Mangrove :

- Mangroves are found in the marshy saline areas of sea shore.
- These type of trees are able to survive in the conditions like high salinity, scarcity of oxygen, and minerals as well as the effects of oceanic waves.
- There are many species of mangroves, Each one is used in different ways.
- Wood of mangroves, is used as fuel, to prepare doors windows, cup boards etc. Tannin can also be extracted from its bark by cutting it.
- It stops the soil erosion of seashore.
- They are helpful to aquatic birds to build nests, as well as in breeding.
- Humns is prepared naturally around the mangroves.
- Bacterial and fungal colonies develop on the dried up leaves of mangrove, which are used as food by protista.
- Herbivore insects and mangrove crabs eat leaves of mangroves.



Figure 13.8

Reasons for decreasing number of mangroves :

- Storm
- Deforestation by men for various purpose
- Due to the grazing activities by cattle keepers some of the seedling get destroyed.

13 ♦ Environmental Equilibrium



Thus plants are very useful to us, what can we do to protect and conserve trees?



- 32 Species of mangrove out of 44 Asian species are found in India.
- 11 species of mangrove are found in the gulf of Kuchh from 13 species found on the western shore of India.
- Marshy land of Mangrove is a very productive one where 8 ton humus is produced per year per hectar.
- Surrounding area of mangrove is a breeding site for many marine organisms, which includes many animals like bivalves, insects, molluscans, amphibions, mycids, crabs, lobsters, Ostracods, shrimps and others.
- About 105 species of fish, 20 species of jellyfish and 229 species of crabs are found in Indian mangrove forest.

The means to maintain environmental and natural equilibrium :

- We should stop deforestation and grow more and more trees and rear.
- We should protect air, water and soil against pollution and destroy those harmful waste property.
- We should carefully use chemical fertilizers and pestisides.
- Prepare natural pesticides using herbs if possible
- We should nurture environment by protecting useful insects, birds and animals.
- We should stop hunting of animals. birds etc.

13 ♦ Environmental Equilibrium

- We should provide proper space to animals by developing national parks and sanctuaries.
- Special projects should be launched to protect endangered species. We should be helpful to the government projects like 'Project Tiger, Lion Protection', 'Deer Protection'
- Such arrangements should be developed in which coexistence of man with other organisms can be maintained, if the future of living world is safe only in that case existence of human is possible.
- The problem like heavy rain, draught, extreme heat, earthquake, tsunami, global warming occurred due to the environmental imbalance are dangerous for human existence.
- Only Mankind is responsible for these types of problems.
- Hence it is our own duty to protect and nature the environment.

Environment will save us if we save the environment

Nature will protect us if we protect the nature.



- Q.1** What type of problems occur due to environmental imbalance?
- Q.2** Write importance of environmental equilibrium.
- Q.3** Which type of efforts would you do to conserve the environmental equilibrium?
- Q.4 Do this :**
- (1) Prepare an album of pictures of extinct animal and bird species.
 - (2) Get additional information by visiting your nearby national park, sanctuary, wet lands or forest.

