

HORNBILL

Textbook in English

for Class XI

(Core Course)



2018-19

(राष्ट्रीय शैक्षिक अनुसंधान और प्रशिक्षण परिषद् द्वारा विकसित)
राज्य शैक्षिक अनुसंधान और प्रशिक्षण परिषद् छत्तीसगढ़ द्वारा स्वीकृत
STATE COUNCIL OF EDUCATIONAL RESEARCH AND TRAINING CHHATTISGARH

मूल्य - ₹ 50.00

छत्तीसगढ़ शासन, स्कूल शिक्षा विभाग द्वारा स्वीकृत

राष्ट्रीय शैक्षिक अनुसंधान और प्रशिक्षण परिषद्, नई दिल्ली
के सौजन्य से छत्तीसगढ़ राज्य के निमित्त

© राष्ट्रीय शैक्षिक अनुसंधान और प्रशिक्षण परिषद्, नई दिल्ली

संस्करण – 2018

आवरण पृष्ठ सज्जा
रेखराज चौरागड़े

प्रकाशक

राज्य शैक्षिक अनुसंधान और प्रशिक्षण परिषद् छत्तीसगढ़

मुद्रक

छत्तीसगढ़ पाठ्यपुस्तक निगम, रायपुर

मुद्रणालय

मुद्रित पुस्तकों की संख्या –

(आवरण पृष्ठ 220 जी.एस.एम. एवं आंतरिक पृष्ठ 80 जी.एस.एम. कागज पर मुद्रित)

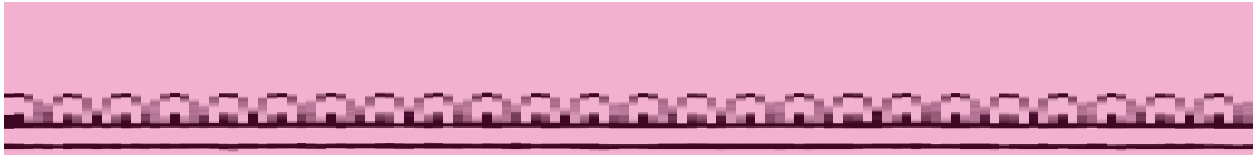

प्राक्कथन

राष्ट्रीय शिक्षा नीति में यह स्पष्ट रूप से उल्लेखित है, अवसर की असमानता को कम करना। शिक्षा को राष्ट्रीय आवश्यकताओं के अनुरूप बनाना। मौजूदा आधारभूत सुविधाओं का बेहतर उपयोग करना। शिक्षा का स्तर सुधारना तथा शिक्षा में विज्ञान एवं प्रौद्योगिकी को महत्व देना। इन्हीं आधारभूत तत्वों को ध्यान में रखते हुए शिक्षाविदों ने हर क्षेत्र में जनहित के लिए शिक्षा हेतु पाठ्यक्रम तैयार करने की कोशिश की है जिसे हर प्रांत (राज्य) में लागू करके ही हम अपने देश में अपनी भावी पीढ़ी के लिए और उनके लाभ के लिए एक ही प्रकार की शिक्षा प्रदान कर सकते हैं और उनको एक ही प्रकार की शिक्षा देकर उनका आपस में मुकाबला करवा के उनसे अपने देश, अपने राज्य के प्रति एक सकारात्मक सोच उत्पन्न कर शिक्षा का स्वप्न साकार कर सकते हैं। इन्हीं बातों को ध्यान में रखते हुए एन.सी.ई.आर.टी. की पाठ्यपुस्तकों को छत्तीसगढ़ शासन, स्कूल शिक्षा विभाग के निर्णयानुसार अप्रैल 2018 से राज्य की उच्चतर माध्यमिक कक्षा ग्यारहवीं हेतु लागू किया गया है।

विविधता में एकता इस देश की परम्परा रही है। इस परम्परा को कायम रखते हुए शिक्षा के स्तर को उठाने के लिए तथा अन्य देशों के साथ विकास के आयाम पूरे करने के लिए छत्तीसगढ़ राज्य में अध्ययनरत उच्चतर माध्यमिक शिक्षा के गुणवत्तापूर्ण विकास के लिए प्रारंभिक शिक्षा एवं साक्षरता विभाग, मानव संसाधन विकास मंत्रालय तथा भारत सरकार द्वारा समय-समय पर राज्यों को एक ही राष्ट्रीय स्तर पर पाठ्यक्रम स्वीकृत करने व एन.सी.ई.आर.टी. की पुस्तकों को प्रदेश में लागू करने के लिए कहा जाता रहा है। उल्लेखनीय है कि 2017 से राष्ट्रीय स्तर पर मेडिकल प्रवेश परीक्षा का होना इसी बात का परिचायक है। भविष्य में तकनीकी परीक्षाओं के लिए भी ऐसा सोचा जा सकता है। पुनश्च कक्षा 12 वीं के बाद होने वाली अधिकतर प्रतियोगी परीक्षाओं का आयोजन सी.बी.एस.ई. द्वारा किया जाता है तथा सी.बी.एस.ई. द्वारा ली जाने वाली परीक्षाओं में एन.सी.ई.आर.टी. की किताबों से ही प्रश्न पूछे जाते हैं। अतः राष्ट्रीय स्तर पर ली जाने वाली परीक्षाओं की तैयारी के लिए एक जैसी सामग्री का होना आवश्यक है।

इस नए पाठ्यक्रम के आलोक में एन.सी.ई.आर.टी., नई दिल्ली द्वारा विकसित कला, विज्ञान एवं वाणिज्य विषयक पाठ्यपुस्तकें, जिसे छत्तीसगढ़ पाठ्यपुस्तक निगम द्वारा नवीन आवरण पृष्ठ की डिजाइनिंग कर मुद्रित किया गया है, को छत्तीसगढ़ राज्य में पाठ्यपुस्तक के रूप में स्वीकार किया गया है। कक्षा ग्यारहवीं में अध्ययनरत छात्रों के लिए स्वीकृत एन.सी.ई.आर.टी. की ये पुस्तकें छत्तीसगढ़ राज्य की वर्तमान एवं भावी पीढ़ी के लिए ज्ञानोपयोगी सिद्ध होंगी। एन.सी.ई.आर.टी. के निदेशक तथा प्रकाशन विभाग के प्रति हम आभारी हैं जिन्होंने छत्तीसगढ़ राज्य के लिए एन.सी.ई.आर.टी., नई दिल्ली द्वारा सृजित पाठ्यपुस्तकों के लिए त्वरित स्वीकृति व बहुमूल्य मार्ग निर्देशन देकर पुस्तक की गुणवत्ता विकास व सुधार हेतु आवश्यक सुझाव एवं सहयोग प्रदान किया है।

हमें आशा ही नहीं, पूर्ण विश्वास है कि यह पुस्तक, ज्ञानवर्धक, ज्ञानोपयोगी एवं उपलब्धि स्तर की वृद्धि में सहायक सिद्ध होगी, यद्यपि संवर्धन एवं परिष्करण की सम्भावनाएँ सदैव भविष्य के लिए संचित रहती हैं, फिर भी प्रकाशन एवं मुद्रण में निरन्तर अभिवृद्धि करने के प्रति निष्ठा एवं समर्पण के साथ राज्य शैक्षिक अनुसंधान और प्रशिक्षण परिषद्, छत्तीसगढ़ के छात्रों, अभिभावकों, शिक्षकों एवं शिक्षाविदों की टिप्पणियों तथा बहुमूल्य सुझावों का सदैव स्वागत करेगा जिससे छत्तीसगढ़ राज्य को देश के शिक्षा जगत में उच्चतम लब्धप्रतिष्ठित होने में हमारा लघु प्रयास सहायक सिद्ध हो सके। समस्त छात्र-छात्राओं की उज्ज्वल भविष्य की शुभकामनाओं के साथ...

संचालक

राज्य शैक्षिक अनुसंधान और प्रशिक्षण परिषद्
छत्तीसगढ़, रायपुर



About the Book

THIS textbook for Class XI is based on the English syllabus on the lines suggested by the National Curriculum Framework, 2005. It aims to help learners develop proficiency in English by using language as an instrument for abstract thought and knowledge acquisition.

In the Reading Skills section, the texts have been chosen to mirror the kind of serious reading in real life that a school-leaver should be capable of. The prose pieces are drawn from biographies, travelogues, science fiction, art and contemporary expository prose by writers from different parts of the world. Samples from journalistic writing have also been included. The play, placed centrally in the textbook, is on a theme that learners will particularly identify with and is in a lighter vein. The poems relate to universal sentiments and appeal to contemporary sensibilities.

Learners at this stage bring along with them a rich resource of world-view, knowledge and cognitive strategies. Teachers should encourage them to make educated guesses at what they read and help them initially to make sense of the language of the text and subsequently become autonomous readers. The Notes after every Unit help the teacher and learners with strategies for dealing with the particular piece.

The activities suggested draw upon the learners' multilingual experiences and capacities. Comprehension is addressed at two levels: one of the text itself and the other of how the text relates to the learners' experience. The vocabulary exercises will sensitise learners to make informed choices of words, while the points of grammar highlighted will help them notice the use of forms. The 'Things to Do' section at the end of every unit invites learners to look for other sources of information that will help them deal with learning tasks across the curriculum.

The section on Writing Skills prepares them for the kind of independent writing that a school-leaver will need to engage in for academic as well as real-life purposes. Help has been provided in a step-by-step manner to lead the learners on to make notes, summarise, draft letters and write short essays, paying attention to the form, content and the process of writing.

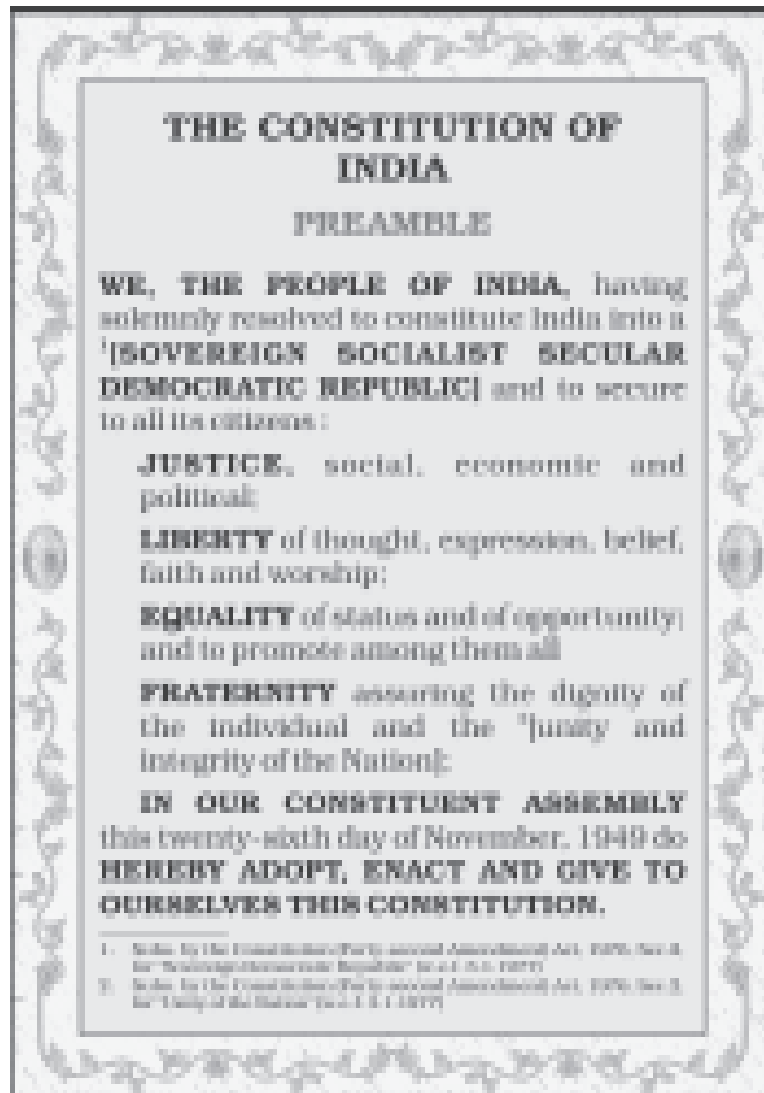

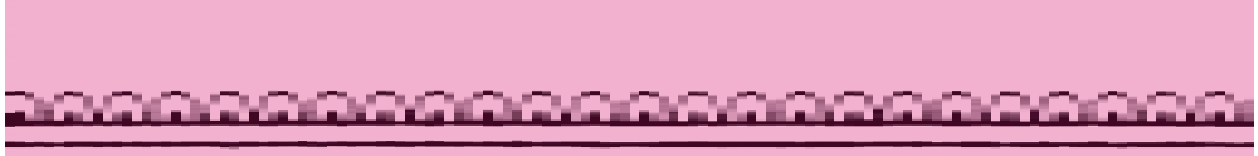

Textbook Development Committee

CHAIRPERSON, ADVISORY GROUP FOR TEXTBOOKS IN LANGUAGES

Professor Namwar Singh, formerly *Chairman*, School of Languages,
Jawaharlal Nehru University, New Delhi

CHIEF ADVISOR

R. Amritavalli, *Professor*, English and Foreign Languages University
(EFLU), Hyderabad

CHIEF COORDINATOR

Ram Janma Sharma, Former *Professor* and *Head*, Department of
Education in Languages, NCERT, New Delhi

MEMBERS

Indu Khetarpal, *Principal*, Salwan Public School, Gurgaon

Malathy Krishnan, *Reader*, EFLU, Hyderabad

Nasiruddin Khan, *Reader* (Retd.), NCERT, New Delhi

Rashmi Mishra, *PGT (English)*, Jawahar Navodaya Vidyalaya,
P.O. Kalamati, Sambalpur

MEMBER – COORDINATOR

Meenakshi Khar, *Assistant Professor of English*, Department of
Education in Languages, NCERT, New Delhi

Acknowledgements

THE National Council of Educational Research and Training is grateful to Professor M.L. Tickoo, formerly of the Central Institute of English and Foreign Languages, Hyderabad, and the Regional Language Centre, Singapore; Geetha Kumar, *PGT*, The Mothers' International School; and Vandana Singh, *Consultant Editor* for going through the manuscript and making valuable suggestions.

For permission to reproduce copyright material in this book NCERT would like to thank the following: Pergamon Press (Aust) for 'A Photograph' by Shirley Toulson and 'Father to Son' by Elizabeth Jennings; Oxford University Press for 'We're Not Afraid to Die... if We Can Be Together' by Gordon Cook and Alan East; National Geographic Society for 'Discovering Tut: the Saga Continues' by A.R. Williams and 'Green Sahara' by Joel Achenbach; Oxford University Press for 'The Laburnum Top' by Ted Hughes and 'Childhood' by Markus Natten; The India International Society for 'Landscape of the Soul' by Nathalie Trouveroy; New York University Press for 'The Voice of the Rain' by Walt Whitman; Bhartiya Vidya Bhavan for 'The Ailing Planet' by Nani Palkhivala; The Gale Group Inc. for 'The Browning Version' by Terence Rattigan; Publishers Witness Books for 'The Adventure' by Jayant Narlikar; John Murray for 'Silk Road' by Nick Middleton; Editor-in-Chief, *The Hindu* for 'A New Deal for Old Cities' by G.Ananthakrishnan; HT Media Ltd for 'Getting Inside Outsider Art' by Brinda Suri.

The National Council of Educational Research and Training, New Delhi, acknowledges the services of Sunanda Khanna, *Copy Editor*; Surender K. Vats, *Proof Reader*; Mohammad Harun and Uttam Kumar, *DTP Operators*; and Parash Ram Kaushik, *Incharge*, Computer Station. The efforts of the Publication Department, NCERT are also highly appreciated.



Contents

FOREWORD	iii
ABOUT THE BOOK	v
READING SKILLS	1-86
1. The Portrait of a Lady KHUSHWANT SINGH	3
<i>A Photograph</i> SHIRLEY TOULSON	11
2. We're Not Afraid to Die... if We Can All Be Together GORDON COOK and ALAN EAST	13
3. Discovering Tut: the Saga Continues A.R. WILLIAMS	22
<i>The Laburnum Top</i> TED HUGHES	31
4. Landscape of the Soul NATHALIE TROUVEROY	34
<i>The Voice of the Rain</i> WALT WHITMAN	41
5. The Ailing Planet: the Green Movement's Role NANI PALKHIVALA	43

x

6.	The Browning Version	50
	TERENCE RATTIGAN	
	<i>Childhood</i>	58
	MARKUS NATTEN	
7.	The Adventure	60
	JAYANT NARLIKAR	
8.	Silk Road	74
	NICK MIDDLETON	
	<i>Father to Son</i>	85
	ELIZABETH JENNINGS	
	WRITING SKILLS	87-118
1.	Note-making	89
2.	Summarising	94
3.	Sub-titling	99
4.	Essay-writing	102
5.	Letter-writing	107
6.	Creative Writing	116

The Portrait of a Lady

A Photograph

“We’re Not Afraid to Die... if We
Can All Be Together”

Discovering Tut: the Saga Continues

The Laburnum Top

Landscape of the Soul

The Voice of the Rain

The Ailing Planet: the Green
Movement’s Role

The Browning Version

Childhood

The Adventure

Silk Road

Father to Son

Reading Skills

Effective reading is receiving from others their ideas and feelings.

Effective reading involves

- ◆ understanding the text
- ◆ talking about the text
- ◆ thinking about language
- ◆ working with words
- ◆ noticing form and patterns.

1 The Portrait of a Lady

Khushwant Singh

*Notice these expressions in the text.
Infer their meaning from the context.*

- ◆ the thought was almost revolting
- ◆ an expanse of pure white serenity
- ◆ a turning-point
- ◆ accepted her seclusion with resignation
- ◆ a veritable bedlam of chirrupings
- ◆ frivolous rebukes
- ◆ the sagging skins of the dilapidated drum

My grandmother, like everybody's grandmother, was an old woman. She had been old and wrinkled for the twenty years that I had known her. People said that she had once been young and pretty and had even had a husband, but that was hard to believe. My grandfather's portrait hung above the mantelpiece in the drawing room. He wore a big turban and loose-fitting clothes. His long, white beard covered the best part of his chest and he looked at least a hundred years old. He did not look the sort of person who would have a wife or children. He looked as if he could only have lots and lots of grandchildren. As for my grandmother being young and pretty, **the thought was almost revolting**. She often told us of the games she used to play as a child. That seemed quite absurd and undignified on her part and we treated it like the fables of the Prophets she used to tell us.

She had always been short and fat and slightly bent. Her face was a criss-cross of wrinkles running from everywhere to everywhere. No, we were certain she had always been as we had

known her. Old, so terribly old that she could not have grown older, and had stayed at the same age for twenty years. She could never have been pretty; but she was always beautiful. She hobbled about the house in spotless white with one hand resting on her waist to balance her stoop and the other telling the beads of her rosary. Her silver locks were scattered untidily over her pale, puckered face, and her lips constantly moved in inaudible prayer. Yes, she was beautiful. She was like the winter landscape in the mountains, **an expanse of pure white serenity** breathing peace and contentment.

My grandmother and I were good friends. My parents left me with her when they went to live in the city and we were constantly together. She used to wake me up in the morning and get me ready for school. She said her morning prayer in a monotonous sing-song while she bathed and dressed me in the hope that I would listen and get to know it by heart; I listened because I loved her voice but never bothered to learn it. Then she would fetch my wooden slate which she had already washed and plastered with yellow chalk, a tiny earthen ink-pot and a red pen, tie them all in a bundle and hand it to me. After a breakfast of a thick, stale chapatti with a little butter and sugar spread on it, we went to school. She carried several stale chapattis with her for the village dogs.

My grandmother always went to school with me because the school was attached to the temple. The priest taught us the alphabet and the morning prayer. While the children sat in rows on either side of the verandah singing the alphabet or the prayer in a chorus, my grandmother sat inside reading the scriptures. When we had both finished, we would walk back together. This time the village dogs would meet us at the temple door. They followed us to our home growling and fighting with each other for the chapattis we threw to them.

When my parents were comfortably settled in the city, they sent for us. That was **a turning-point** in our friendship. Although we shared the same room, my grandmother no longer came to school with me. I used to go to an English school in a motor bus. There were no dogs in the streets and she took to feeding sparrows in the courtyard of our city house.

As the years rolled by we saw less of each other. For some time she continued to wake me up and get me ready for school. When I came back she would ask me what the teacher had

taught me. I would tell her English words and little things of western science and learning, the law of gravity, Archimedes' Principle, the world being round, etc. This made her unhappy. She could not help me with my lessons. She did not believe in the things they taught at the English school and was distressed that there was no teaching about God and the scriptures. One day I announced that we were being given music lessons. She was very disturbed. To her music had lewd associations. It was the monopoly of harlots and beggars and not meant for gentlefolk. She said nothing but her silence meant disapproval. She rarely talked to me after that.

When I went up to University, I was given a room of my own. The common link of friendship was snapped. My grandmother **accepted her seclusion with resignation**. She rarely left her spinning-wheel to talk to anyone. From sunrise to sunset she sat by her wheel spinning and reciting prayers. Only in the afternoon she relaxed for a while to feed the sparrows. While she sat in the verandah breaking the bread into little bits, hundreds of little birds collected round her creating **a veritable bedlam of chirrupings**. Some came and perched on her legs, others on her shoulders. Some even sat on her head. She smiled but never shooed them away. It used to be the happiest half-hour of the day for her.

When I decided to go abroad for further studies, I was sure my grandmother would be upset. I would be away for five years, and at her age one could never tell. But my grandmother could. She was not even sentimental. She came to leave me at the railway station but did not talk or show any emotion. Her lips moved in prayer, her mind was lost in prayer. Her fingers were busy telling the beads of her rosary. Silently she kissed my forehead, and when I left I cherished the moist imprint as perhaps the last sign of physical contact between us.

But that was not so. After five years I came back home and was met by her at the station. She did not look a day older. She still had no time for words, and while she clasped me in her arms I could hear her reciting her prayers. Even on the first day of my arrival, her happiest moments were with her sparrows whom she fed longer and with **frivolous rebukes**.

In the evening a change came over her. She did not pray. She collected the women of the neighbourhood, got an old drum and started to sing. For several hours she thumped **the sagging**

skins of the dilapidated drum and sang of the home-coming of warriors. We had to persuade her to stop to avoid overstraining. That was the first time since I had known her that she did not pray.

The next morning she was taken ill. It was a mild fever and the doctor told us that it would go. But my grandmother thought differently. She told us that her end was near. She said that, since only a few hours before the close of the last chapter of her life she had omitted to pray, she was not going to waste any more time talking to us.

We protested. But she ignored our protests. She lay peacefully in bed praying and telling her beads. Even before we could suspect, her lips stopped moving and the rosary fell from her lifeless fingers. A peaceful pallor spread on her face and we knew that she was dead.

We lifted her off the bed and, as is customary, laid her on the ground and covered her with a red shroud. After a few hours of mourning we left her alone to make arrangements for her funeral. In the evening we went to her room with a crude stretcher to take her to be cremated. The sun was setting and had lit her room and verandah with a blaze of golden light. We stopped half-way in the courtyard. All over the verandah and in her room right up to where she lay dead and stiff wrapped in the red shroud, thousands of sparrows sat scattered on the floor. There was no chirruping. We felt sorry for the birds and my mother fetched some bread for them. She broke it into little crumbs, the way my grandmother used to, and threw it to them. The sparrows took no notice of the bread. When we carried my grandmother's corpse off, they flew away quietly. Next morning the sweeper swept the bread crumbs into the dustbin.

Understanding the text

Mention

1. The three phases of the author's relationship with his grandmother before he left the country to study abroad.
2. Three reasons why the author's grandmother was disturbed when he started going to the city school.

3. Three ways in which the author's grandmother spent her days after he grew up.
4. The odd way in which the author's grandmother behaved just before she died.
5. The way in which the sparrows expressed their sorrow when the author's grandmother died.

Talking about the text

Talk to your partner about the following.

1. The author's grandmother was a religious person. What are the different ways in which we come to know this?
2. Describe the changing relationship between the author and his grandmother. Did their feelings for each other change?
3. Would you agree that the author's grandmother was a person strong in character? If yes, give instances that show this.
4. Have you known someone like the author's grandmother? Do you feel the same sense of loss with regard to someone whom you have loved and lost?

Thinking about language

1. Which language do you think the author and his grandmother used while talking to each other?
2. Which language do you use to talk to elderly relatives in your family?
3. How would you say 'a dilapidated drum' in your language?
4. Can you think of a song or a poem in your language that talks of homecoming?

Working with words

- I. Notice the following uses of the word 'tell' in the text.
 1. Her fingers were busy *telling the beads* of her rosary.
 2. I would *tell her* English words and little things of Western science and learning.
 3. At her age *one could never tell*.
 4. She *told us* that her end was near.

Given below are four different senses of the word 'tell'. Match the meanings to the uses listed above.

1. make something known to someone in spoken or written words
2. count while reciting
3. be sure
4. give information to somebody

II. Notice the different senses of the word 'take'.

1. to *take to* something: to begin to do something as a habit
2. to *take ill*: to suddenly become ill

Locate these phrases in the text and notice the way they are used.

III. The word 'hobble' means to walk with difficulty because the legs and feet are in bad condition.

Tick the words in the box below that also refer to a manner of walking.

haggle	shuffle	stride	ride	waddle
wriggle	paddle	swagger	trudge	slog

Noticing form ■

Notice the form of the verbs italicised in these sentences.

1. My grandmother was an old woman. She *had been* old and wrinkled for the twenty years that I *had known* her. People said that she *had* once *been* young and pretty and *had* even *had* a husband, but that was hard to believe.
2. When we both *had finished* we would walk back together.
3. When I came back she would ask me what the teacher *had taught* me.
4. It was the first time since I *had known* her that she did not pray.
5. The sun was setting and *had lit* her room and verandah with a golden light.

These are examples of the past perfect forms of verbs. When we recount things in the distant past we use this form.

Things to do

Talk with your family members about elderly people who you have been intimately connected with and who are not there with you now. Write a short description of someone you liked a lot.

Notes

Understanding the text

The tasks cover the entire text and help in summarising the various phases of the autobiographical account and are based on the facts presented.

- Ask the students to read the text silently, paragraph by paragraph, and get a quick oral feedback on what the main points of each are. For example: Para 1– description of grandmother and grandfather’s photograph.
- At the end of the unit ask students to answer the comprehension questions first orally and then in writing in point form. For example, when he went to the:
 - village school
 - city school
 - university

Talking about the text

Peer interaction about the text is necessary before students engage in writing tasks. The questions raised in this section elicit subjective responses to the facts in the text and also open up possibilities for relating the events to the reader’s own life and establish the universality of the kind of relationship and feelings described in the text.

Thinking about language

The questions here try to:

- make the reader visualise the language that must have been used by the author and his grandmother
- think about their own home language

- find equivalents in their language for English phrases
- relate to songs with emotional import in their own language.

Working with words ■

Highlight different uses of common words like 'tell' and 'take'; words used for different ways of walking; and semantically-related word groups. You could add to the items by using the dictionary for vocabulary enrichment.

Noticing form ■

Make students notice the use of the past perfect form of the verb that frequently appear in the text to recount the remote past. You could practise the form with other examples.

Things to do ■

Relating the topic of the text to the reader's real-life experience; writing about a person who one holds dear.

A Photograph

Shirley Toulson

The cardboard shows me how it was
When the two girl cousins went paddling,
Each one holding one of my mother's hands,
And she the big girl — some twelve years or so.
All three stood still to smile through their hair
At the uncle with the camera. A sweet face,
My mother's, that was before I was born.
And the sea, which appears to have changed less,
Washed their terribly transient feet.

Some twenty — thirty — years later
She'd laugh at the snapshot. "See Betty
And Dolly," she'd say, "and look how they
Dressed us for the beach." The sea holiday
Was her past, mine is her laughter. Both wry
With the laboured ease of loss.

Now she's been dead nearly as many years
As that girl lived. And of this circumstance
There is nothing to say at all.
Its silence silences.

Infer the meanings of the following words from the context.

paddling

transient

Now look up the dictionary to see if your inference is right.

Think it out

1. What does the word 'cardboard' denote in the poem? Why has this word been used?
2. What has the camera captured?
3. What has not changed over the years? Does this suggest something to you?
4. The poet's mother laughed at the snapshot. What did this laugh indicate?
5. What is the meaning of the line "Both wry with the laboured ease of loss."
6. What does "this circumstance" refer to?
7. The three stanzas depict three different phases. What are they?

Notes

Poems are included to heighten students' sensitivity to literary writing and to appreciate rhythm and sound patterns in language. Follow these steps:

- Read the poem aloud once without the students looking at the poem. Ask them a few general questions.
 - Re-read the poem with the students looking at the poem. Ask a few more questions to check comprehension.
 - Ask students to read the poem silently and answer the questions given, first orally and then in writing.
-
- The poem 'A Photograph' is placed after 'The Portrait of a Lady' because of the thematic relation between the two.
 - The questions seek to examine factual and inferential comprehension, establish empathy and draw attention to the structure of the poem and choice of words.

2. “We’re Not Afraid to Die... if We Can All Be Together”

Gordon Cook and Alan East

*Notice these expressions in the text.
Infer their meaning from the context.*

- ◆ honing our seafaring skills
- ◆ ominous silence
- ◆ Mayday calls
- ◆ pinpricks in the vast ocean
- ◆ a tousled head

In July 1976, my wife Mary, son Jonathan, 6, daughter Suzanne, 7, and I set sail from Plymouth, England, to duplicate the round-the-world voyage made 200 years earlier by Captain James Cook. For the longest time, Mary and I — a 37-year-old businessman — had dreamt of sailing in the wake of the famous explorer, and for the past 16 years we had spent all our leisure time **honing our seafaring skills** in British waters.

Our boat *Wavewalker*, a 23 metre, 30 ton wooden-hulled beauty, had been professionally built, and we had spent months fitting it out and testing it in the roughest weather we could find.

The first leg of our planned three-year, 105,000 kilometre journey passed pleasantly as we sailed down the west coast of Africa to Cape Town. There, before heading east, we took on two crewmen — American Larry Vigil and Swiss Herb Seigler — to help us tackle one of the world’s roughest seas, the southern Indian Ocean.

On our second day out of Cape Town, we began to encounter strong gales. For the next few weeks, they blew continuously. Gales did not worry me; but the size of the waves was alarming — up to 15 metres, as high as our main mast.

December 25 found us 3,500 kilometres east of Cape Town. Despite atrocious weather, we had a wonderful holiday complete with a Christmas tree. New Year's Day saw no improvement in the weather, but we reasoned that it had to change soon. And it did change — for the worse.

At dawn on January 2, the waves were gigantic. We were sailing with only a small storm jib and were still making eight knots. As the ship rose to the top of each wave we could see endless enormous seas rolling towards us, and the screaming of the wind and spray was painful to the ears. To slow the boat down, we dropped the storm jib and lashed a heavy mooring rope in a loop across the stern. Then we double-lashed everything, went through our life-raft drill, attached lifelines, donned oilskins and life jackets — and waited.

The first indication of impending disaster came at about 6 p.m., with an **ominous silence**. The wind dropped, and the sky immediately grew dark. Then came a growing roar, and an enormous cloud towered aft of the ship. With horror, I realised that it was not a cloud, but a wave like no other I had ever seen. It appeared perfectly vertical and almost twice the height of the other waves, with a frightful breaking crest.

The roar increased to a thunder as the stern moved up the face of the wave, and for a moment I thought we might ride over it. But then a tremendous explosion shook the deck. A torrent of green and white water broke over the ship, my head smashed into the wheel and I was aware of flying overboard and sinking below the waves. I accepted my approaching death, and as I was losing consciousness, I felt quite peaceful.

Unexpectedly, my head popped out of the water. A few metres away, *Wavewalker* was near capsizing, her masts almost horizontal. Then a wave hurled her upright, my lifeline jerked taut, I grabbed the guard rails and sailed through the air into *Wavewalker's* main boom. Subsequent waves tossed me around the deck like a rag doll. My left ribs cracked; my mouth filled with blood and broken teeth. Somehow, I found the wheel, lined up the stern for the next wave and hung on.

Water, Water, Everywhere. I could feel that the ship had water below, but I dared not abandon the wheel to investigate. Suddenly,

the front hatch was thrown open and Mary appeared. "We're sinking!" she screamed. "The decks are smashed; we're full of water."

"Take the wheel", I shouted as I scrambled for the hatch.

Larry and Herb were pumping like madmen. Broken timbers hung at crazy angles, the whole starboard side bulged inwards; clothes, crockery, charts, tins and toys sloshed about in deep water.

I half-swam, half-crawled into the children's cabin. "Are you all right?" I asked. "Yes," they answered from an upper bunk. "But my head hurts a bit," said Sue, pointing to a big bump above her eyes. I had no time to worry about bumped heads.

After finding a hammer, screws and canvas, I struggled back on deck. With the starboard side bashed open, we were taking water with each wave that broke over us. If I couldn't make some repairs, we would surely sink.

Somehow I managed to stretch canvas and secure waterproof hatch covers across the gaping holes. Some water continued to stream below, but most of it was now being deflected over the side.

More problems arose when our hand pumps started to block up with the debris floating around the cabins and the electric pump short-circuited. The water level rose threateningly. Back on deck I found that our two spare hand pumps had been wrenched overboard — along with the forestay sail, the jib, the dinghies and the main anchor.

Then I remembered we had another electric pump under the chartroom floor. I connected it to an out-pipe, and was thankful to find that it worked.

The night dragged on with an endless, bitterly cold routine of pumping, steering and working the radio. We were getting no replies to our **Mayday calls** — which was not surprising in this remote corner of the world.

Sue's head had swollen alarmingly; she had two enormous black eyes, and now she showed us a deep cut on her arm. When I asked why she hadn't made more of her injuries before this, she replied, "I didn't want to worry you when you were trying to save us all."

By morning on January 3, the pumps had the water level sufficiently under control for us to take two hours' rest in rotation. But we still had a tremendous leak somewhere below the waterline and, on checking, I found that nearly all the boat's

main rib frames were smashed down to the keel. In fact, there was nothing holding up a whole section of the starboard hull except a few cupboard partitions.

We had survived for 15 hours since the wave hit, but *Wavewalker* wouldn't hold together long enough for us to reach Australia. I checked our charts and calculated that there were two small islands a few hundred kilometres to the east. One of them, Ile Amsterdam, was a French scientific base. Our only hope was to reach these **pinpricks in the vast ocean**. But unless the wind and seas abated so we could hoist sail, our chances would be slim indeed. The great wave had put our auxilliary engine out of action.

On January 4, after 36 hours of continuous pumping, we reached the last few centimetres of water. Now, we had only to keep pace with the water still coming in. We could not set any sail on the main mast. Pressure on the rigging would simply pull the damaged section of the hull apart, so we hoisted the storm jib and headed for where I thought the two islands were. Mary found some corned beef and cracker biscuits, and we ate our first meal in almost two days.

But our respite was short-lived. At 4 p.m. black clouds began building up behind us; within the hour the wind was back to 40 knots and the seas were getting higher. The weather continued to deteriorate throughout the night, and by dawn on January 5, our situation was again desperate.

When I went in to comfort the children, Jon asked, "Daddy, are we going to die?" I tried to assure him that we could make it. "But, Daddy," he went on, "we aren't afraid of dying if we can all be together — you and Mummy, Sue and I."

I could find no words with which to respond, but I left the children's cabin determined to fight the sea with everything I had. To protect the weakened starboard side, I decided to heave-to — with the undamaged port hull facing the oncoming waves, using an improvised sea anchor of heavy nylon rope and two 22 litre plastic barrels of paraffin.

That evening, Mary and I sat together holding hands, as the motion of the ship brought more and more water in through the broken planks. We both felt the end was very near.

But *Wavewalker* rode out the storm and by the morning of January 6, with the wind easing, I tried to get a reading on the sextant. Back in the chartroom, I worked on wind speeds,

changes of course, drift and current in an effort to calculate our position. The best I could determine was that we were somewhere in 150,000 kilometres of ocean looking for a 65 kilometre-wide island.

While I was thinking, Sue, moving painfully, joined me. The left side of her head was now very swollen and her blackened eyes narrowed to slits. She gave me a card she had made.

On the front she had drawn caricatures of Mary and me with the words: "Here are some funny people. Did they make you laugh? I laughed a lot as well." Inside was a message: "Oh, how I love you both. So this card is to say thank you and let's hope for the best." Somehow we had to make it.

I checked and rechecked my calculations. We had lost our main compass and I was using a spare which had not been corrected for magnetic variation. I made an allowance for this and another estimate of the influence of the westerly currents which flow through this part of the Indian Ocean.

About 2 p.m., I went on deck and asked Larry to steer a course of 185 degrees. If we were lucky, I told him with a conviction I did not feel, he could expect to see the island at about 5 p.m.

Then with a heavy heart, I went below, climbed on my bunk and amazingly, dozed off. When I woke it was 6 p.m., and growing dark. I knew we must have missed the island, and with the sail we had left, we couldn't hope to beat back into the westerly winds.

At that moment, **a tousled head** appeared by my bunk. "Can I have a hug?" Jonathan asked. Sue was right behind him.

"Why am I getting a hug now?" I asked.

"Because you are the best daddy in the whole world — and the best captain," my son replied.

"Not today, Jon, I'm afraid."

"Why, you must be," said Sue in a matter-of-fact voice. "You found the island."

"What!" I shouted.

"It's out there in front of us," they chorused, "as big as a battleship."

I rushed on deck and gazed with relief at the stark outline of Ile Amsterdam. It was only a bleak piece of volcanic rock, with little vegetation — the most beautiful island in the world!

We anchored offshore for the night, and the next morning all 28 inhabitants of the island cheered as they helped us ashore.

With land under my feet again, my thoughts were full of Larry and Herbie, cheerful and optimistic under the direst stress, and of Mary, who stayed at the wheel for all those crucial hours. Most of all, I thought of a seven-year-old girl, who did not want us to worry about a head injury (which subsequently took six minor operations to remove a recurring blood clot between skin and skull), and of a six-year-old boy who was not afraid to die.

Understanding the text

1. List the steps taken by the captain
 - (i) to protect the ship when rough weather began.
 - (ii) to check the flooding of the water in the ship.
2. Describe the mental condition of the voyagers on 4 and 5 January.
3. Describe the shifts in the narration of the events as indicated in the three sections of the text. Give a subtitle to each section.

Talking about the text

Discuss the following questions with your partner.

1. What difference did you notice between the reaction of the adults and the children when faced with danger?
2. How does the story suggest that optimism helps to endure “the direst stress”?
3. What lessons do we learn from such hazardous experiences when we are face-to-face with death?
4. Why do you think people undertake such adventurous expeditions in spite of the risks involved?

Thinking about language

1. We have come across words like ‘gale’ and ‘storm’ in the account. Here are two more words for ‘storm’: typhoon, cyclone. How many words does your language have for ‘storm’?

2. Here are the terms for different kinds of vessels: yacht, boat, canoe, ship, steamer, schooner. Think of similar terms in your language.
3. 'Catamaran' is a kind of a boat. Do you know which Indian language this word is derived from? Check the dictionary.
4. Have you heard any boatmen's songs? What kind of emotions do these songs usually express?

Working with words

1. The following words used in the text as ship terminology are also commonly used in another sense. In what contexts would you use the other meaning?

knot	stern	boom	hatch	anchor
------	-------	------	-------	--------

2. The following three compound words end in -ship. What does each of them mean?

airship	flagship	lightship
---------	----------	-----------

3. The following are the meanings listed in the dictionary against the phrase 'take on'. In which meaning is it used in the third paragraph of the account:

take on sth: to begin to have a particular quality or appearance; to assume sth

take sb on: to employ sb; to engage sb
to accept sb as one's opponent in a game, contest or conflict

take sb/sth on: to decide to do sth; to allow sth/sb to enter e.g. a bus, plane or ship; to take sth/sb on board

Things to do

1. Given on the next page is a picture of a yacht. Label the parts of the yacht using the terms given in the box.

bow	cabin	rudder	cockpit
stern	boom	mainsail	mast

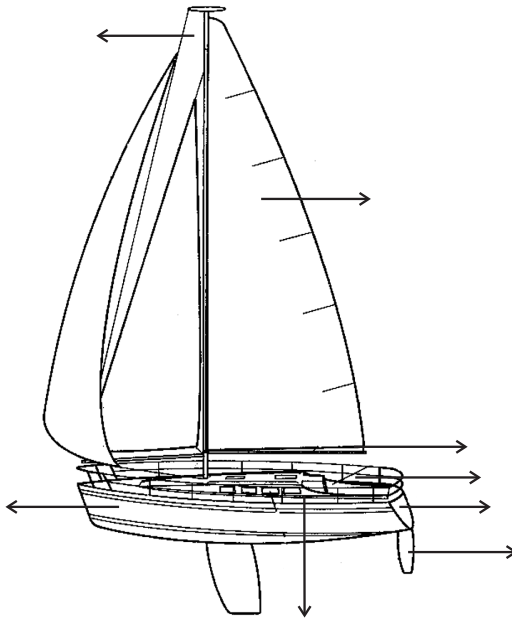

2. Here is some information downloaded from the Internet on Ile Amsterdam. You can view images of the isle if you go online.

Location	South Indian Ocean, between southernmost parts of Australia and South Africa
Latitude and longitude	37 92 S, 77 67 E
Sovereignty	France
Political status notes	Part of French Southern and Antarctic Lands
Population	35
Census notes	Meteorological station staff
Land area in square kilometres	86

3. Locate Ile Amsterdam on the world map.

Notes

This is a first person account of an adventurous ordeal that a family experiences.

Understanding the text ■

This section deals with factual and global comprehension. Practice is given in describing and noticing text organisation.

Talking about the text ■

Peer interaction about subjective responses to the text; empathy with and comment on universal experiences; and human behaviour related to risk-taking and adventure.

Thinking about language ■

- Variety of terms for a particular item in different languages
- English words derived from Indian languages
- Linking language to music (boatmen's songs)

Working with words ■

- 'Ship' terms as homonyms.
- Compound words with '-ship' with different connotations
- Phrasal verbs

Things to do ■

- Honing reference skills by finding facts from the Internet, the encyclopedia, and maps
- Exposure to various genres of fact presentation

3. *Discovering Tut : the Saga Continues*

A. R. Williams

*Notice these expressions in the text.
Infer their meaning from the context.*

- ◆ forensic reconstruction
- ◆ scudded across
- ◆ casket grey
- ◆ resurrection
- ◆ funerary treasures
- ◆ circumvented
- ◆ computed tomography
- ◆ eerie detail



*He was just a teenager when he died. The last heir of a powerful family that had ruled Egypt and its empire for centuries, he was laid to rest laden with gold and eventually forgotten. Since the discovery of his tomb in 1922, the modern world has speculated about what happened to him, with murder being the most extreme possibility. Now, leaving his tomb for the first time in almost 80 years, Tut has undergone a CT scan that offers new clues about his life and death — and provides precise data for an accurate **forensic reconstruction** of the boyish pharaoh.*

An angry wind stirred up ghostly dust devils as King Tut was taken from his resting place in the ancient Egyptian cemetery known as the Valley of the Kings*. Dark-bellied clouds had **scudded across** the desert sky all day and now were veiling the stars in **casket grey**. It was 6 p.m. on 5 January 2005. The world's most famous mummy glided head first into a CT scanner brought here to probe the lingering medical mysteries of this little understood young ruler who died more than 3,300 years ago.

All afternoon the usual line of tourists from around the world had descended into the cramped, rock-cut tomb some 26 feet underground to pay their respects. They gazed at the murals on the walls of the burial chamber and peered at Tut's gilded face, the most striking feature of his mummy-shaped outer coffin lid. Some visitors read from guidebooks in a whisper. Others stood silently, perhaps pondering Tut's untimely death in his late teens, or wondering with a shiver if the pharaoh's curse — death or misfortune falling upon those who disturbed him — was really true.

"The mummy is in very bad condition because of what Carter did in the 1920s," said Zahi Hawass, Secretary General of Egypt's Supreme Council of Antiquities, as he leaned over the body for a long first look. Carter—Howard Carter, that is — was the British archaeologist who in 1922 discovered Tut's tomb after years of futile searching. Its contents, though hastily ransacked in antiquity, were surprisingly complete. They remain the richest royal collection ever found and have become part of the pharaoh's legend. Stunning artefacts in gold, their eternal brilliance meant to guarantee **resurrection**, caused a sensation at the time of the discovery — and still get the most attention. But Tut was also buried with everyday things he'd want in the afterlife: board games, a bronze razor, linen undergarments, cases of food and wine.

After months of carefully recording the pharaoh's **funerary treasures**, Carter began investigating his three nested coffins. Opening the first, he found a shroud adorned with garlands of willow and olive leaves, wild celery, lotus petals, and cornflowers, the faded evidence of a burial in March or April. When he finally reached the mummy, though, he ran into trouble. The ritual resins had hardened, cementing Tut to the bottom of his solid gold coffin. "No amount of legitimate force could move them," Carter wrote later. "What was to be done?"

The sun can beat down like a hammer this far south in Egypt, and Carter tried to use it to loosen the resins. For several hours

* See map on next page

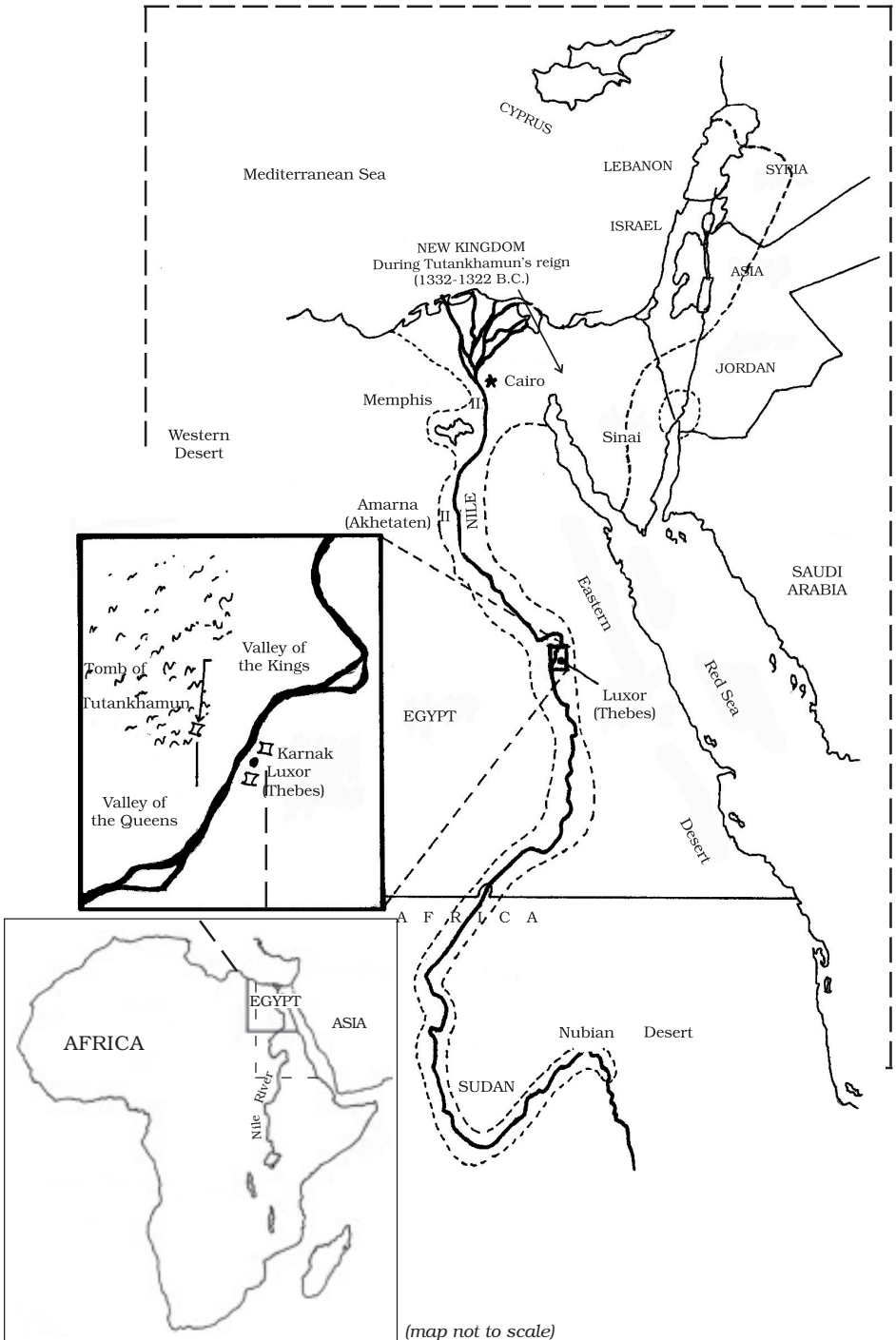

he set the mummy outside in blazing sunshine that heated it to 149 degrees Fahrenheit. Nothing budged. He reported with scientific detachment that “the consolidated material had to be chiselled away from beneath the limbs and trunk before it was possible to raise the king’s remains.”

In his defence, Carter really had little choice. If he hadn’t cut the mummy free, thieves most certainly would have **circumvented** the guards and ripped it apart to remove the gold. In Tut’s time the royals were fabulously wealthy, and they thought — or hoped — they could take their riches with them. For his journey to the great beyond, King Tut was lavished with glittering goods: precious collars, inlaid necklaces and bracelets, rings, amulets, a ceremonial apron, sandals, sheaths for his fingers and toes, and the now iconic inner coffin and mask — all of pure gold. To separate Tut from his adornments, Carter’s men removed the mummy’s head and severed nearly every major joint. Once they had finished, they reassembled the remains on a layer of sand in a wooden box with padding that concealed the damage, the bed where Tut now rests.

Archaeology has changed substantially in the intervening decades, focusing less on treasure and more on the fascinating details of life and intriguing mysteries of death. It also uses more sophisticated tools, including medical technology. In 1968, more than 40 years after Carter’s discovery, an anatomy professor X-rayed the mummy and revealed a startling fact: beneath the resin that cakes his chest, his breast-bone and front ribs are missing.

Today diagnostic imaging can be done with **computed tomography**, or CT, by which hundreds of X-rays in cross section are put together like slices of bread to create a three-dimensional virtual body. What more would a CT scan reveal of Tut than the X-ray? And could it answer two of the biggest questions still lingering about him — how did he die, and how old was he at the time of his death?

King Tut’s demise was a big event, even by royal standards. He was the last of his family’s line, and his funeral was the death rattle of a dynasty. But the particulars of his passing away and its aftermath are unclear.

Amenhotep III — Tut’s father or grandfather — was a powerful pharaoh who ruled for almost four decades at the height of the eighteenth dynasty’s golden age. His son Amenhotep IV succeeded him and initiated one of the strangest periods in the history of

ancient Egypt. The new pharaoh promoted the worship of the Aten, the sun disk, changed his name to Akhenaten, or 'servant of the Aten,' and moved the religious capital from the old city of Thebes to the new city of Akhetaten, known now as Amarna. He further shocked the country by attacking Amun, a major god, smashing his images and closing his temples. "It must have been a horrific time," said Ray Johnson, director of the University of Chicago's research centre in Luxor, the site of ancient Thebes. "The family that had ruled for centuries was coming to an end, and then Akhenaten went a little wacky."

After Akhenaten's death, a mysterious ruler named Smenkhkare appeared briefly and exited with hardly a trace. And then a very young Tutankhaten took the throne — King Tut as he's widely known today. The boy king soon changed his name to Tutankhamun, 'living image of Amun,' and oversaw a restoration of the old ways. He reigned for about nine years — and then died unexpectedly.

Regardless of his fame and the speculations about his fate, Tut is one mummy among many in Egypt. How many? No one knows. The Egyptian Mummy Project, which began an inventory in late 2003, has recorded almost 600 so far and is still counting. The next phase: scanning the mummies with a portable CT machine donated by the National Geographic Society and Siemens, its manufacturer. King Tut is one of the first mummies to be scanned — in death, as in life, moving regally ahead of his countrymen.

A CT machine scanned the mummy head to toe, creating 1,700 digital X-ray images in cross section. Tut's head, scanned in 0.62 millimetre slices to register its intricate structures, takes on **eerie detail** in the resulting image. With Tut's entire body similarly recorded, a team of specialists in radiology, forensics, and anatomy began to probe the secrets that the winged goddesses of a gilded burial shrine protected for so long.

The night of the scan, workmen carried Tut from the tomb in his box. Like pallbearers they climbed a ramp and a flight of stairs into the swirling sand outside, then rose on a hydraulic lift into the trailer that held the scanner. Twenty minutes later two men emerged, sprinted for an office nearby, and returned with a pair of white plastic fans. The million-dollar scanner had quit because of sand in a cooler fan. "Curse of the pharaoh," joked a guard nervously.

Eventually the substitute fans worked well enough to finish the procedure. After checking that no data had been lost, the technicians turned Tut over to the workmen, who carried him back to his tomb. Less than three hours after he was removed from his coffin, the pharaoh again rested in peace where the funerary priests had laid him so long ago.

Back in the trailer a technician pulled up astonishing images of Tut on a computer screen. A grey head took shape from a scattering of pixels, and the technician spun and tilted it in every direction. Neck vertebrae appeared as clearly as in an anatomy class. Other images revealed a hand, several views of the rib cage, and a transection of the skull. But for now the pressure was off. Sitting back in his chair, Zahi Hawass smiled, visibly relieved that nothing had gone seriously wrong. "I didn't sleep last night, not for a second," he said. "I was so worried. But now I think I will go and sleep."



Mural in King Tut's tomb showing King Tut with Osiris, the god of the afterlife

By the time we left the trailer, descending metal stairs to the sandy ground, the wind had stopped. The winter air lay cold and still, like death itself, in this valley of the departed. Just above the entrance to Tut's tomb stood Orion — the constellation that the ancient Egyptians knew as the soul of Osiris, the god of the afterlife — watching over the boy king.

(**Source:** *National Geographic*, Vol 207, No. 6)

Understanding the text

1. Give reasons for the following.
 - (i) King Tut's body has been subjected to repeated scrutiny.
 - (ii) Howard Carter's investigation was resented.
 - (iii) Carter had to chisel away the solidified resins to raise the king's remains.
 - (iv) Tut's body was buried along with gilded treasures.
 - (v) The boy king changed his name from Tutankhaten to Tutankhamun.
2.
 - (i) List the deeds that led Ray Johnson to describe Akhenaten as "wacky".
 - (ii) What were the results of the CT scan?
 - (iii) List the advances in technology that have improved forensic analysis.
 - (iv) Explain the statement, "King Tut is one of the first mummies to be scanned — in death, as in life..."

Talking about the text

Discuss the following in groups of two pairs, each pair in a group taking opposite points of view.

1. Scientific intervention is necessary to unearth buried mysteries.
2. Advanced technology gives us conclusive evidence of past events.
3. Traditions, rituals and funerary practices must be respected.
4. Knowledge about the past is useful to complete our knowledge of the world we live in.

Thinking about language

1. Read the following piece of information from *The Encyclopedia of Language* by David Crystal.
 Egyptian is now extinct: its history dates from before the third millennium B.C., preserved in many hieroglyphic inscriptions and papyrus manuscripts. Around the second century A.D., it developed into a language known as Coptic. Coptic may still have been used as late as the early nineteenth century and is still used as a religious language by Monophysite Christians in Egypt.
2. What do you think are the reasons for the extinction of languages?
3. Do you think it is important to preserve languages?
4. In what ways do you think we could help prevent the extinction of languages and dialects?

Working with words

1. Given below are some interesting combinations of words. Explain why they have been used together.

(i) ghostly dust devils	(vi) dark-bellied clouds
(ii) desert sky	(vii) casket grey
(iii) stunning artefacts	(viii) eternal brilliance
(iv) funerary treasures	(ix) ritual resins
(v) scientific detachment	(x) virtual body
2. Here are some commonly used medical terms. Find out their meanings.

CT scan	MRI	tomography
autopsy	dialysis	ECG
post mortem	angiography	biopsy

Things to do

1. The constellation Orion is associated with the legend of Osiris, the god of the afterlife.

Find out the astronomical descriptions and legends associated with the following.

- (i) Ursa Major (Saptarishi mandala)
 - (ii) Polaris (Dhruva tara)
 - (iii) Pegasus (Winged horse)
 - (iv) Sirius (Dog star)
 - (v) Gemini (Mithuna)
2. Some of the leaves and flowers mentioned in the passage for adorning the dead are willow, olive, celery, lotus, cornflower. Which of these are common in our country?
 3. Name some leaves and flowers that are used as adornments in our country.

Notes

Understanding the text ■

Factual comprehension: giving reasons, listing

Talking about the text ■

Debate on issues raised in the text related to rediscovering history with the help of technology; respect for traditions (reflection on issues)

Thinking about language ■

Extinction of language and language preservation

Working with words ■

Understanding adjectival collocations; common medical terms

Things to do ■

- Relating astronomical facts and legends (across the curriculum)
- Finding out botanical correlates

The Laburnum Top

Ted Hughes

The Laburnum top is silent, quite still
In the afternoon yellow September sunlight,
A few leaves yellowing, all its seeds fallen.

Till the goldfinch comes, with a twitching chirrup
A suddenness, a startlement, at a branch end.
Then sleek as a lizard, and alert, and abrupt,
She enters the thickness, and a machine starts up
Of chitterings, and a tremor of wings, and trillings —
The whole tree trembles and thrills.
It is the engine of her family.
She stokes it full, then flirts out to a branch-end
Showing her barred face identity mask

Then with eerie delicate whistle-chirrup whisperings
She launches away, towards the infinite

And the laburnum subsides to empty.

laburnum: a short tree with hanging branches, yellow flowers and poisonous seeds

goldfinch: a small singing bird with yellow feathers on its wings

Find out

1. What laburnum is called in your language.
2. Which local bird is like the goldfinch.

Think it out

1. What do you notice about the beginning and the ending of the poem?
2. To what is the bird's movement compared? What is the basis for the comparison?
3. Why is the image of the engine evoked by the poet?
4. What do you like most about the poem?
5. What does the phrase "her barred face identity mask" mean?

Note down

1. the sound words
2. the movement words
3. the dominant colour in the poem.

List the following

1. Words which describe 'sleek', 'alert' and 'abrupt'.
2. Words with the sound 'ch' as in 'chart' and 'tr' as in 'trembles' in the poem.
3. Other sounds that occur frequently in the poem.

Thinking about language

Look for some other poem on a bird or a tree in English or any other language.

Try this out

Write four lines in verse form on any tree that you see around you.

Notes

This poem has been placed after a text which has references to names of plants for thematic sequencing.

Understanding the poem ■

- Glossing of 'laburnum' and 'goldfinch'
- Factual understanding
- Movement of thought and structuring (poetic sensitivity)
- Focus on figures of speech and imagery used (poetic sensitivity)
- Attention to sounds, lexical collocations (poetic sensitivity)

Thinking about language ■

- Finding equivalents in other languages (multilingualism)
- Relating to thematically similar poems in other languages (multilingualism)
- Attempt at creativity

4 Landscape of the Soul

Nathalie Trouveroy

*Notice these expressions in the text.
Infer their meaning from the context.*

- ◆ anecdote
- ◆ delicate realism
- ◆ figurative painting
- ◆ illusionistic likeness
- ◆ conceptual space

A WONDERFUL old tale is told about the painter Wu Daozi, who lived in the eighth century. His last painting was a landscape commissioned by the Tang Emperor Xuanzong, to decorate a palace wall. The master had hidden his work behind a screen, so only the Emperor would see it. For a long while, the Emperor admired the wonderful scene, discovering forests, high mountains, waterfalls, clouds floating in an immense sky, men on hilly paths, birds in flight. “Look, Sire”, said the painter, “in this cave, at the foot of the mountain, dwells a spirit.” The painter clapped his hands, and the entrance to the cave opened. “The inside is splendid, beyond anything words can convey. Please let me show Your Majesty the way.” The painter entered the cave; but the entrance closed behind him, and before the astonished Emperor could move or utter a word, the painting had vanished from the wall. Not a trace of Wu Daozi’s brush was left — and the artist was never seen again in this world.

Such stories played an important part in China’s classical education. The books of Confucius and Zhuangzi are full of them; they helped the master to guide his disciple in the right direction. Beyond the **anecdote**, they are deeply revealing of the spirit in

which art was considered. Contrast this story — or another famous one about a painter who wouldn't draw the eye of a dragon he had painted, for fear it would fly out of the painting — with an old story from my native Flanders that I find most representative of Western painting.

In fifteenth century Antwerp, a master blacksmith called Quinten Metsys fell in love with a painter's daughter. The father would not accept a son-in-law in such a profession. So Quinten sneaked into the painter's studio and painted a fly on his latest panel, with such **delicate realism** that the master tried to swat it away before he realised what had happened. Quinten was immediately admitted as an apprentice into his studio. He married his beloved and went on to become one of the most famous painters of his age. These two stories illustrate what each form of art is trying to achieve: a perfect, **illusionistic likeness** in Europe, the essence of inner life and spirit in Asia.

In the Chinese story, the Emperor commissions a painting and appreciates its outer appearance. But the artist reveals to him the true meaning of his work. The Emperor may rule over the territory he has conquered, but only the artist knows the way within. "Let me show the Way", the 'Dao', a word that means both the path or the method, and the mysterious works of the Universe. The painting is gone, but the artist has reached his goal — beyond any material appearance.

A classical Chinese landscape is not meant to reproduce an actual view, as would a Western **figurative painting**. Whereas the European painter wants you to borrow his eyes and look at a particular landscape exactly as he saw it, from a specific angle, the Chinese painter does not choose a single viewpoint. His landscape is not a 'real' one, and you can enter it from any point, then travel in it; the artist creates a path for your eyes to travel up and down, then back again, in a leisurely movement. This is even more true in the case of the horizontal scroll, in which the action of slowly opening one section of the painting, then rolling it up to move on to the other, adds a dimension of time which is unknown in any other form of painting. It also requires the active participation of the viewer, who decides at what pace he will travel through the painting — a participation which is physical as well as mental. The Chinese painter does not want you to borrow his eyes; he wants you to enter his mind. The landscape is an inner one, a spiritual and **conceptual space**.

This concept is expressed as *shanshui*, literally ‘mountain-water’ which used together represent the word ‘landscape’. More than two elements of an image, these represent two complementary poles, reflecting the Daoist view of the universe. The mountain is *Yang* — reaching vertically towards Heaven, stable, warm, and dry in the sun, while the water is *Yin*— horizontal and resting on the earth, fluid, moist and cool. The interaction of *Yin*, the receptive, feminine aspect of universal energy, and its counterpart *Yang*, active and masculine, is of course a fundamental notion of Daoism. What is often overlooked is an essential third element, the Middle Void where their interaction takes place. This can be compared with the yogic practice of *pranayama*; breathe in, retain, breathe out — the suspension of breath is the Void where meditation occurs. The Middle Void is essential — nothing can happen without it; hence the importance of the white, unpainted space in Chinese landscape.

This is also where Man finds a fundamental role. In that space between Heaven and Earth, he becomes the conduit of communication between both poles of the Universe. His presence is essential, even if it’s only suggested; far from being lost or oppressed by the lofty peaks, he is, in Francois Cheng’s wonderful expression, “the eye of the landscape”.

[excerpt from ‘Landscape of the Soul:
Ethics and Spirituality in Chinese
Painting’, slightly edited]

Getting Inside ‘Outsider Art’

When French painter Jean Dubuffet mooted the concept of ‘art brut’ in the 1940s, the art of the untrained visionary was of minority interest. From its almost veiled beginnings, ‘outsider art’ has gradually become the fastest growing area of interest in contemporary art internationally.

This genre is described as the art of those who have ‘no right’ to be artists as they have received no formal training, yet show talent and artistic insight. Their works are a stimulating contrast to a lot of mainstream offerings.

Around the time Dubuffet was propounding his concept, in India “an untutored genius was creating paradise”. Years ago the little patch of jungle that he began clearing to make himself a garden sculpted with stone and



A Rock Garden sculpture made of broken bangles by Nek Chand

recycled material is known to the world today as the Rock Garden, at Chandigarh.

Its 80-year-old creator–director, Nek Chand, is now hailed as India’s biggest contributor to outsider art. The fiftieth issue (Spring 2005) of *Raw Vision*, a UK-based magazine pioneer in outsider art publications, features Nek Chand, and his Rock Garden sculpture ‘Women by the Waterfall’ on its anniversary issue’s cover.

The notion of ‘art brut’ or ‘raw art’, was of works that were in their raw state as regards cultural and artistic influences. Anything and everything from a tin to a sink to a broken down car could be material for a work of art, something Nek Chand has taken to dizzying heights. Recognising his art as “an outstanding testimony of the difference a single man can make when he lives his dream”, the Swiss Commission for UNESCO will be honouring him by way of a European exposition of his works. The five-month interactive show, ‘Realm of Nek Chand’, beginning October will be held at leading museums in Switzerland, Belgium, France and Italy. “The biggest reward is walking through the garden and seeing people enjoy my creation,” Nek Chand says.

BRINDA SURI

Hindustan Times, 28 August 2005

Understanding the text

1. (i) Contrast the Chinese view of art with the European view with examples.
(ii) Explain the concept of *shanshui*.
2. (i) What do you understand by the terms 'outsider art' and 'art brut' or 'raw art'?
(ii) Who was the "untutored genius who created a paradise" and what is the nature of his contribution to art?

Talking about the text

Discuss the following statements in groups of four.

1. "The Emperor may rule over the territory he has conquered, but only the artist knows the way within."
2. "The landscape is an inner one, a spiritual and conceptual space."

Thinking about language

1. Find out the correlates of Yin and Yang in other cultures.
2. What is the language spoken in Flanders?

Working with words

- I. The following common words are used in more than one sense.

panel	studio	brush
essence	material	

Examine the following sets of sentences to find out what the words, 'panel' and 'essence' mean in different contexts.

1. (i) The masks from Bawa village in Mali look like long *panels* of decorated wood.
(ii) Judge H. Hobart Grooms told the jury *panel* he had heard the reports.
(iii) The *panel* is laying the groundwork for an international treaty.

- (iv) The glass *panels* of the window were broken.
 - (v) Through the many round tables, workshops and *panel* discussions, a consensus was reached.
 - (vi) The sink in the hinged *panel* above the bunk drains into the head.
2. (i) Their repetitive structure must have taught the people around the great composer the *essence* of music.
 - (ii) Part of the answer is in the proposition; but the *essence* is in the meaning.
 - (iii) The implications of these schools of thought are of practical *essence* for the teacher.
 - (iv) They had added vanilla *essence* to the pudding.
- II. Now find five sentences each for the rest of the words to show the different senses in which each of them is used.

Noticing form

- A classical Chinese landscape is not meant to reproduce an actual view, *as* would a Western figurative painting.
- *Whereas* the European painter wants you to borrow his eyes and look at a particular landscape exactly as he saw it, from a specific angle, the Chinese painter does not choose a single viewpoint.

The above two examples are ways in which contrast may be expressed. Combine the following sets of ideas to show the contrast between them.

1. (i) European art tries to achieve a perfect, illusionistic likeness.
- (ii) Asian art tries to capture the essence of inner life and spirit.
2. (i) The Emperor commissions a painting and appreciates its outer appearance.
- (ii) The artist reveals to him the true meaning of his work.
3. (i) The Emperor may rule over the territory he has conquered.
- (ii) The artist knows the way within.

Things to do

1. Find out about as many Indian schools of painting as you can. Write a short note on the distinctive features of each school.
2. Find out about experiments in recycling that help in environmental conservation.

Notes

Understanding the text ■

Factual and global understanding

Talking about the text ■

Discussing spiritual experiences

Thinking about language ■

- Inter-cultural philosophical viewpoints and related terms
- Knowing about the languages of the world

Working with words ■

Using words according to their function

Noticing form ■

Use of conjunctions to express contrast

Soaring Interest in Chinese Art

A painting by an 86-year old Chinese master has gone under the hammer for a record 30 million yuan, highlighting soaring world interest in Chinese art.

The work by Wu Guanzhong depicting a cluster of colourful parrots sitting on tree branches smashed the previous record price for a Chinese ink painting of 23 million yuan for a twelfth century masterpiece by the Song Dynasty emperor, Huizong. "Wu Guanzhong has successfully melded Chinese and Western artistic traditions," said Ma Zhefei, marketing manager from China's Poly Art and Culture Co.

The Voice of the Rain

Walt Whitman

And who art thou? said I to the soft-falling shower,
Which, strange to tell, gave me an answer, as here translated:
I am the Poem of Earth, said the voice of the rain,
Eternal I rise impalpable out of the land and the
bottomless sea,
Upward to heaven, whence, vaguely form'd, altogether
changed, and yet the same,
I descend to lave the droughts, atomies, dust-layers of
the globe,
And all that in them without me were seeds only, latent,
unborn;
And forever, by day and night, I give back life to my
own origin,
And make pure and beautify it;
(For song, issuing from its birth-place, after fulfilment,
wandering
Reck'd or unreck'd, duly with love returns.)

■ **impalpable:** something that cannot be touched

lave: wash; bathe

atomies: tiny particles

latent: hidden

■

Think it out

- I.
 1. There are two voices in the poem. Who do they belong to? Which lines indicate this?
 2. What does the phrase “strange to tell” mean?
 3. There is a parallel drawn between rain and music. Which words indicate this? Explain the similarity between the two.
 4. How is the cyclic movement of rain brought out in the poem? Compare it with what you have learnt in science.
 5. Why are the last two lines put within brackets?
 6. List the pairs of opposites found in the poem.

- II. Notice the following sentence patterns.
 1. And who art thou? *said I* to the soft-falling shower.
 2. I am the Poem of Earth, *said the voice of the rain*.
 3. *Eternal I rise*
 4. For song... *duly with love returns*

Rewrite the above sentences in prose.

- III. Look for some more poems on the rain and see how this one is different from them.

— Notes —

This is a nature poem celebrating the coming of the rain.

Understanding the poem

- Voices in the poem
- Sense of the poem
- Relating to the process of rainfall scientifically (across the curriculum)
- Noticing sentence structure in poems
- Comparison with other rain poems

5 The Ailing Planet : the Green Movement's Rde

Nani Palkhivala

*Notice these expressions in the text.
Infer their meaning from the context.*

- ◆ a holistic and ecological view
- ◆ sustainable development
- ◆ languish
- ◆ ignominious darkness
- ◆ inter alia
- ◆ decimated
- ◆ catastrophic depletion
- ◆ transcending concern

The following article was written by Nani Palkhivala and published in The Indian Express on 24 November 1994. The issues that he raised regarding the declining health of the earth continue to have relevance.

ONE cannot recall any movement in world history which has gripped the imagination of the entire human race so completely and so rapidly as the Green Movement which started nearly twenty-five years ago. In 1972 the world's first nationwide Green party was founded in New Zealand. Since then, the movement has not looked back.

We have shifted — one hopes, irrevocably — from the mechanistic view to **a holistic and ecological view** of the world. It is a shift in human perceptions as revolutionary as that

introduced by Copernicus who taught mankind in the sixteenth century that the earth and the other planets revolved round the sun. For the first time in human history, there is a growing worldwide consciousness that the earth itself is a living organism — an enormous being of which we are parts. It has its own metabolic needs and vital processes which need to be respected and preserved.

The earth's vital signs reveal a patient in declining health. We have begun to realise our ethical obligations to be good stewards of the planet and responsible trustees of the legacy to future generations.

The concept of **sustainable development** was popularised in 1987 by the World Commission on Environment and Development. In its report it defined the idea as “Development that meets the needs of the present, without compromising the ability of future generations to meet their needs”, i.e., without stripping the natural world of resources future generations would need.

In the zoo at Lusaka, Zambia, there is a cage where the notice reads, ‘The world’s most dangerous animal’. Inside the cage there is no animal but a mirror where you see yourself. Thanks to the efforts of a number of agencies in different countries, a new awareness has now dawned upon the most dangerous animal in the world. He has realised the wisdom of shifting from a system based on domination to one based on partnership.

Scientists have catalogued about 1.4 million living species with which mankind shares the earth. Estimates vary widely as regards the still-uncatalogued living species — biologists reckon that about three to a hundred million other living species still **languish** unnamed in **ignominious darkness**.

One of the early international commissions which dealt, **inter alia**, with the question of ecology and environment was the Brandt Commission which had a distinguished Indian as one of its members — Mr L.K. Jha. The First Brandt Report raised the question — “Are we to leave our successors a scorched planet of advancing deserts, impoverished landscapes and ailing environment?”

Mr Lester R. Brown in his thoughtful book, *The Global Economic Prospect*, points out that the earth's principal biological systems are four — fisheries, forests, grasslands, and croplands — and they form the foundation of the global

economic system. In addition to supplying our food, these four systems provide virtually all the raw materials for industry except minerals and petroleum-derived synthetics. In large areas of the world, human claims on these systems are reaching an unsustainable level, a point where their productivity is being impaired. When this happens, fisheries collapse, forests disappear, grasslands are converted into barren wastelands, and croplands deteriorate. In a protein-conscious and protein-hungry world, over-fishing is common every day. In poor countries, local forests are being **decimated** in order to procure firewood for cooking. In some places, firewood has become so expensive that "what goes under the pot now costs more than what goes inside it". Since the tropical forest is, in the words of Dr Myers, "the powerhouse of evolution", several species of life face extinction as a result of its destruction.

It has been well said that forests precede mankind; deserts follow. The world's ancient patrimony of tropical forests is now eroding at the rate of forty to fifty million acres a year, and the growing use of dung for burning deprives the soil of an important natural fertiliser. The World Bank estimates that a five-fold increase in the rate of forest planting is needed to cope with the expected fuelwood demand in the year 2000.

James Speth, the President of the World Resources Institute, said the other day, "We were saying that we are losing the forests at an acre a second, but it is much closer to an acre-and-a-half to a second".

Article 48A of the Constitution of India provides that "the State shall endeavour to protect and improve the environment and to safeguard the forests and wildlife of the country". But what causes endless anguish is the fact that laws are never respected nor enforced in India. (For instance, the Constitution says that casteism, untouchability and bonded labour shall be abolished, but they flourish shamelessly even after forty-four years of the operation of the Constitution.) A recent report of our Parliament's Estimates Committee has highlighted the near **catastrophic depletion** of India's forests over the last four decades. India, according to reliable data, is losing its forests at the rate of 3.7 million acres a year. Large areas, officially designated as forest land, "are already virtually treeless". The actual loss of forests is estimated to be about eight times the rate indicated by government statistics.

A three-year study using satellites and aerial photography conducted by the United Nations, warns that the environment has deteriorated so badly that it is 'critical' in many of the eighty-eight countries investigated.

There can be no doubt that the growth of world population is one of the strongest factors distorting the future of human society. It took mankind more than a million years to reach the first billion. That was the world population around the year 1800. By the year 1900, a second billion was added, and the twentieth century has added another 3.7 billion. The present world population is estimated at 5.7 billion. Every four days the world population increases by one million.

Fertility falls as incomes rise, education spreads, and health improves. Thus development is the best contraceptive. But development itself may not be possible if the present increase in numbers continues.

The rich get richer, and the poor beget children which condemns them to remain poor. More children does not mean more workers, merely more people without work. It is not suggested that human beings be treated like cattle and compulsorily sterilised. But there is no alternative to voluntary family planning without introducing an element of coercion. The choice is really between control of population and perpetuation of poverty.

The population of India is estimated to be 920 million today — more than the entire populations of Africa and South America put together. No one familiar with the conditions in India would doubt that the hope of the people would die in their hungry hutments unless population control is given topmost priority.

For the first time in human history we see a **transcending concern** — the survival not just of the people but of the planet. We have begun to take a holistic view of the very basis of our existence. The environmental problem does not necessarily signal our demise, it is our passport for the future. The emerging new world vision has ushered in the Era of Responsibility. It is a holistic view, an ecological view, seeing the world as an integrated whole rather than a dissociated collection of parts.

Industry has a most crucial role to play in this new Era of Responsibility. What a transformation would be effected if more

businessmen shared the view of the Chairman of Du Pont, Mr Edgar S. Woolard who, five years ago, declared himself to be the Company's "Chief Environmental Officer". He said, "Our continued existence as a leading manufacturer requires that we excel in environmental performance."

Of all the statements made by Margaret Thatcher during the years of her Prime Ministership, none has passed so decisively into the current coin of English usage as her felicitous words: "No generation has a freehold on this earth. All we have is a life tenancy — with a full repairing lease". In the words of Mr Lester Brown, "We have not inherited this earth from our forefathers; we have borrowed it from our children."

Understanding the text

1. Locate the lines in the text that support the title 'The Ailing Planet'.
2. What does the notice 'The world's most dangerous animal' at a cage in the zoo at Lusaka, Zambia, signify?
3. How are the earth's principal biological systems being depleted?
4. Why does the author aver that the growth of world population is one of the strongest factors distorting the future of human society?

Talking about the text

Discuss in groups of four.

1. Laws are never respected nor enforced in India.
2. "Are we to leave our successors a scorched planet of advancing deserts, impoverished landscapes and an ailing environment?"
3. "We have not inherited this earth from our forefathers; we have borrowed it from our children".
4. The problems of overpopulation that directly affect our everyday life.

Thinking about language

The phrase 'inter alia' meaning 'among other things' is one of the many Latin expressions commonly used in English.

Find out what these Latin phrases mean.

1. prima facie
2. ad hoc
3. in camera
4. ad infinitum
5. mutatis mutandis
6. caveat
7. tabula rasa

Working with words

- I. Locate the following phrases in the text and study their connotation.
 1. gripped the imagination of
 2. dawned upon
 3. ushered in
 4. passed into current coin
 5. passport of the future
- II. The words 'grip', 'dawn', 'usher', 'coin', 'passport' have a literal as well as a figurative meaning. Write pairs of sentences using each word in the literal as well as the figurative sense.

Things to do

1. Make posters to highlight the importance of the Green Movement.
2. Maintain a record of the trees cut down and the parks demolished in your area, or any other act that violates the environment. Write to newspapers reporting on any such acts that disturb you.

Notes

Understanding the text ■

- Environmental issues
- Social issues

Talking about the text ■

- Contemporary issues
- Envisioning the future

Thinking about language ■

Latin expressions commonly used

Working with words ■

- Connotations
- Finding literal and figurative meanings

Things to do ■

Making children aware of their responsibilities towards the environment

6 The Browning Version

Terence Rattigan

*Notice these expressions in the text.
Infer their meaning from the context.*

- | | | |
|------------|--------------------|-----------------|
| ◆ remove | ◆ kept in | ◆ sadist |
| ◆ slackers | ◆ got carried away | ◆ shrivelled up |
| ◆ muck | ◆ cut | |

This is an excerpt from The Browning Version. The scene is set in a school. Frank is young and Crocker-Harris, middle-aged. Both are masters. Taplow is a boy of sixteen who has come in to do extra work for Crocker-Harris. But the latter has not yet arrived, and Frank finds Taplow waiting.*

FRANK: Do I know you?

TAPLOW: No, sir.

FRANK: What's your name?

TAPLOW: Taplow.

FRANK: Taplow! No, I don't. You're not a scientist I gather?

TAPLOW: No, sir, I'm still in the lower fifth. I can't specialise until next term — that's to say, if I've got my **remove** all right.

FRANK: Don't you know if you've got your remove?

TAPLOW: No sir, Mr Crocker-Harris doesn't tell us the results like the other masters.

* The reference within the play of Robert Browning's translation of the Greek tragedy, *Agamemnon*

- FRANK: Why not?
- TAPLOW: Well, you know what he's like, sir.
- FRANK: I believe there is a rule that form results should only be announced by the headmaster on the last day of term.
- TAPLOW: Yes — but who else pays attention to it — except Mr Crocker-Harris?
- FRANK: I don't, I admit — but that's no criterion. So you've got to wait until tomorrow to know your fate, have you?
- TAPLOW: Yes, sir.
- FRANK: Supposing the answer is favourable — what then?
- TAPLOW: Oh — science, sir, of course.
- FRANK: (*sadly*) Yes. We get all the **slackers**.
- TAPLOW: (*protestingly*) I'm extremely interested in science, sir.
- FRANK: Are you? I'm not. Not, at least, in the science I have to teach.
- TAPLOW: Well, anyway, sir, it's a good deal more exciting than this **muck** (*indicating his book*).
- FRANK: What is this muck?
- TAPLOW: Aeschylus, sir. The *Agamemnon*.
- FRANK: And your considered view is that the *Agamemnon* is muck?
- TAPLOW: Well, no, sir. I don't think the play is muck — exactly. I suppose, in a way, it's rather a good plot, really, a wife murdering her husband and all that. I only meant the way it's taught to us — just a lot of Greek words strung together and fifty lines if you get them wrong.
- FRANK: You sound a little bitter, Taplow.
- TAPLOW: I am rather, sir.
- FRANK: **Kept in**, eh?
- TAPLOW: No, sir. Extra work.
- FRANK: Extra work — on the last day of school?

- TAPLOW: Yes, sir, and I might be playing golf. You'd think he'd have enough to do anyway himself, considering he's leaving tomorrow for good — but oh no, I missed a day last week when I was ill — so here I am — and look at the weather, sir.
- FRANK: Bad luck. Still there's one comfort. You're pretty well certain to get your remove tomorrow for being a good boy in taking extra work.
- TAPLOW: Well, I'm not so sure, sir. That would be true of the ordinary masters, all right. They just wouldn't dare not to give a chap a remove after his taking extra work. But those sort of rules don't apply to the Crock — Mr Crocker-Harris. I asked him yesterday outright if he'd given me a remove and do you know what he said, sir?
- FRANK: No. What?
- TAPLOW: (*imitating a very gentle, rather throaty voice*) "My dear Taplow, I have given you exactly what you deserve. No less; and certainly no more." Do you know sir, I think he may have marked me down, rather than up, for taking extra work. I mean, the man's hardly human. (*He breaks off quickly.*) Sorry, sir. Have I gone too far?
- FRANK: Yes. Much too far.
- TAPLOW: Sorry, sir. I **got carried away**.
- FRANK: Evidently. (*He picks up a newspaper and opens it*) — Er Taplow.
- TAPLOW: Yes, sir?
- FRANK: What was that Crocker-Harris said to you? Just — er — repeat it, would you?
- TAPLOW: (*imitating again*) "My dear Taplow, I have given you exactly what you deserve. No less; and certainly no more."
- FRANK: (*looking severe*) Not in the least like him. Read your nice Aeschylus and be quiet.
- TAPLOW: (*with dislike*) Aeschylus.

- FRANK: Look, what time did Mr Crocker-Harris tell you to be here?
- TAPLOW: Six-thirty, sir.
- FRANK: Well, he's ten minutes late. Why don't you **cut**? You could still play golf before lock-up.
- TAPLOW: (*really shocked*) Oh, no, I couldn't cut. Cut the Crock — Mr Crocker-Harris? I shouldn't think it's ever been done in the whole time he's been here. God knows what would happen if I did. He'd probably follow me home, or something...
- FRANK: I must admit I envy him the effect he seems to have on you boys in the form. You all seem scared to death of him. What does he do — beat you all, or something?
- TAPLOW: Good Lord, no. He's not a **sadist**, like one or two of the others.
- FRANK: I beg your pardon?
- TAPLOW: A sadist, sir, is someone who gets pleasure out of giving pain.
- FRANK: Indeed? But I think you went on to say that some other masters...
- TAPLOW: Well, of course, they are, sir. I won't mention names, but you know them as well as I do. Of course I know most masters think we boys don't understand a thing — but, sir, you're different. You're young — well, comparatively, anyway — and you're science. You must know what sadism is.
- FRANK: (*after a pause*) Good Lord! What are our schools coming to?
- TAPLOW: Anyway, the Crock isn't a sadist. That's what I'm saying. He wouldn't be so frightening if he were — because at least it would show he had some feelings. But he hasn't. He's all **shrivelled up** inside like a nut and he seems to hate people to like him. It's funny, that. I don't know any other master who doesn't like being liked —

- FRANK: And I don't know any boy who doesn't use that for his own purposes.
- TAPLOW: Well, it's natural sir. But not with the Crock —
- FRANK: Mr Crocker-Harris.
- TAPLOW: Mr Crocker-Harris. The funny thing is that in spite of everything, I do rather like him. I can't help it. And sometimes I think he sees it and that seems to shrivel him up even more —
- FRANK: I'm sure you're exaggerating.
- TAPLOW: No, sir. I'm not. In form the other day he made one of his classical jokes. Of course nobody laughed because nobody understood it, myself included. Still, I knew he'd meant it as funny, so I laughed. Out of ordinary common politeness, and feeling a bit sorry for him for having made a poor joke. Now I can't remember what the joke was, but suppose I make it. Now you laugh, sir. *(Frank laughs.)*
- TAPLOW: *(in a gentle, throaty voice)* "Taplow — you laughed at my little joke, I noticed. I must confess that I am pleased at the advance your Latin has made since you so readily have understood what the rest of the form did not. Perhaps, now, you would be good enough to explain it to them, so that they too can share your pleasure".

The door up right is pushed open and Millie Crocker-Harris enters. She is a thin woman in her late thirties, rather more smartly dressed than the general run of schoolmasters' wives. She is wearing a cape and carries a shopping basket. She closes the door and then stands by the screen watching Taplow and Frank. It is a few seconds before they notice her.

- FRANK: Come along, Taplow *(moves slowly above the desk)*. Do not be so selfish as to keep a good joke to yourself. Tell the others... *(He breaks off suddenly, noticing Millie.)* Oh Lord!

Frank turns quickly, and seems infinitely relieved at seeing Millie.

FRANK: Oh, hullo.

MILLIE: *(without expression)* Hullo. *(She comes down to the sideboard and puts her basket on it.)*

TAPLOW: *(moving up to left of Frank; whispering frantically)* Do you think she heard?

FRANK: *(shakes his head comfortingly. Millie takes off her cape and hangs it on the hall-stand.)* I think she did. She was standing there quite a time.

TAPLOW: If she did and she tells him, there goes my remove.

FRANK: Nonsense. *(He crosses to the fireplace.)*

Millie takes the basket from the sideboard, moves above the table and puts the basket on it.

MILLIE: *(to Taplow)* Waiting for my husband?

TAPLOW: *(moving down left of the table)* Er-yes.

MILLIE: He's at the Bursar's and might be there quite a time. If I were you I'd go.

TAPLOW: *(doubtfully)* He said most particularly I was to come.

MILLIE: Well, why don't you run away for a quarter of an hour and come back? *(She unpacks some things from the basket.)*

TAPLOW: Supposing he gets here before me?

MILLIE: *(smiling)* I'll take the blame. *(She takes a prescription out of the basket.)* I tell you what — you can do a job for him. Take this prescription to the chemist and get it made up.

TAPLOW: All right, Mrs Crocker-Harris. *(He crosses towards the door up right.)*

Understanding the text

1. Comment on the attitude shown by Taplow towards Crocker-Harris.
2. Does Frank seem to encourage Taplow's comments on Crocker-Harris?
3. What do you gather about Crocker-Harris from the play?

Talking about the text

Discuss with your partners

1. Talking about teachers among friends.
2. The manner you adopt when you talk about a teacher to other teachers.
3. Reading plays is more interesting than studying science.

Working with words

A sadist is a person who gets pleasure out of giving pain to others.

Given below are some dictionary definitions of certain kinds of persons. Find out the words that fit these descriptions.

1. A person who considers it very important that things should be correct or genuine e.g. in the use of language or in the arts: P...
2. A person who believes that war and violence are wrong and will not fight in a war: P...
3. A person who believes that nothing really exists: N...
4. A person who is always hopeful and expects the best in all things: O...
5. A person who follows generally accepted norms of behaviour: C...
6. A person who believes that material possessions are all that matter in life: M...

Things to do

Based on the text enact your own version of the play. Work in pairs.

Notes

After the students have read the play silently by themselves, ask them to take on the roles of the three characters and read their parts aloud.

Understanding the text ■

Global comprehension

Talking about the text ■

- Speaking to each other about something that most students do: commenting on their teachers (To teachers — take this in a spirit of good humour)
- Reflecting on how we talk about others in their absence
- Science and Literature: the dichotomy

Working with words ■

Common terms used for people with particular behaviour patterns or beliefs, taking off from the text with the word 'sadist'.

Things to do ■

Instead of conventional role-play involving reading out or enacting the original text, students are encouraged to make their own versions of the play based on the same content (creativity, fun and authenticity).

Childhood

Markus Natten

When did my childhood go?
Was it the day I ceased to be eleven,
Was it the time I realised that Hell and Heaven,
Could not be found in Geography,
And therefore could not be,
Was that the day!

When did my childhood go?
Was it the time I realised that adults were not
all they seemed to be,
They talked of love and preached of love,
But did not act so lovingly,
Was that the day!

When did my childhood go?
Was it when I found my mind was really mine,
To use whichever way I choose,
Producing thoughts that were not those of other people
But my own, and mine alone
Was that the day!

Where did my childhood go?
It went to some forgotten place,
That's hidden in an infant's face,
That's all I know.

Think it out

1. Identify the stanza that talks of each of the following.

individuality

rationalism

hypocrisy

2. What according to the poem is involved in the process of growing up?
3. What is the poet's feeling towards childhood?
4. Which do you think are the most poetic lines? Why?

Notes

Understanding the poem

Questions are based on

- Thematic comprehension
- Reflection on theme
- Poetic sensibility

7 The Adventure

Jayant Narlikar

*Notice these expressions in the text.
Infer their meaning from the context.*

- ◆ blow-by-blow account
- ◆ morale booster
- ◆ relegated to
- ◆ political acumen
- ◆ de facto
- ◆ astute
- ◆ doctored accounts
- ◆ gave vent to

THE Jijamata Express sped along the Pune-Bombay* route considerably faster than the Deccan Queen. There were no industrial townships outside Pune. The first stop, Lonavala, came in 40 minutes. The ghat section that followed was no different from what he knew. The train stopped at Karjat only briefly and went on at even greater speed. It roared through Kalyan.

Meanwhile, the racing mind of Professor Gaitonde had arrived at a plan of action in Bombay. Indeed, as a historian he felt he should have thought of it sooner. He would go to a big library and browse through history books. That was the surest way of finding out how the present state of affairs was reached. He also planned eventually to return to Pune and have a long talk with Rajendra Deshpande, who would surely help him understand what had happened.

That is, assuming that in this world there existed someone called Rajendra Deshpande!

The train stopped beyond the long tunnel. It was a small station called Sarhad. An Anglo-Indian in uniform went through the train checking permits.

The present story is an adapted version. The original text of the story can be consulted on the NCERT website : www.ncert.nic.in

* Now known as Mumbai

“This is where the British Raj begins. You are going for the first time, I presume?” Khan Sahib asked.

“Yes.” The reply was factually correct. Gangadharpant had not been to this Bombay before. He ventured a question: “And, Khan Sahib, how will you go to Peshawar?”

“This train goes to the Victoria Terminus*. I will take the Frontier Mail tonight out of Central.”

“How far does it go? By what route?”

“Bombay to Delhi, then to Lahore and then Peshawar. A long journey. I will reach Peshawar the day after tomorrow.”

Thereafter, Khan Sahib spoke a lot about his business and Gangadharpant was a willing listener. For, in that way, he was able to get some flavour of life in this India that was so different.

The train now passed through the suburban rail traffic. The blue carriages carried the letters, GBMR, on the side.

“Greater Bombay Metropolitan Railway,” explained Khan Sahib. “See the tiny Union Jack painted on each carriage? A gentle reminder that we are in British territory.”

The train began to slow down beyond Dadar and stopped only at its destination, Victoria Terminus. The station looked remarkably neat and clean. The staff was mostly made up of Anglo-Indians and Parsees along with a handful of British officers.

As he emerged from the station, Gangadharpant found himself facing an imposing building. The letters on it proclaimed its identity to those who did not know this Bombay landmark:

EAST INDIA HOUSE HEADQUARTERS OF
THE EAST INDIA COMPANY

Prepared as he was for many shocks, Professor Gaitonde had not expected this. The East India Company had been wound up shortly after the events of 1857 — at least, that is what history books said. Yet, here it was, not only alive but flourishing. So, history had taken a different turn, perhaps before 1857. How and when had it happened? He had to find out.

As he walked along Hornby Road, as it was called, he found a different set of shops and office buildings. There was no Handloom House building. Instead, there were Boots and Woolworth departmental stores, imposing offices of Lloyds, Barclays and other British banks, as in a typical high street of a town in England.

* Now known as Chattrapati Shivaji Terminus

He turned right along Home Street and entered Forbes building.

"I wish to meet Mr Vinay Gaitonde, please," he said to the English receptionist.

She searched through the telephone list, the staff list and then through the directory of employees of all the branches of the firm. She shook her head and said, "I am afraid I can't find anyone of that name either here or in any of our branches. Are you sure he works here?"

This was a blow, not totally unexpected. If he himself were dead in this world, what guarantee had he that his son would be alive? Indeed, he may not even have been born!

He thanked the girl politely and came out. It was characteristic of him not to worry about where he would stay. His main concern was to make his way to the library of the Asiatic Society to solve the riddle of history. Grabbing a quick lunch at a restaurant, he made his way to the Town Hall.

Yes, to his relief, the Town Hall was there, and it did house the library. He entered the reading room and asked for a list of history books including his own.

His five volumes duly arrived on his table. He started from the beginning. Volume one took the history up to the period of Ashoka, volume two up to Samudragupta, volume three up to Mohammad Ghori and volume four up to the death of Aurangzeb. Up to this period history was as he knew it. The change evidently had occurred in the last volume.

Reading volume five from both ends inwards, Gangadharant finally converged on the precise moment where history had taken a different turn.

That page in the book described the Battle of Panipat, and it mentioned that the Marathas won it handsomely. Abdali was routed and he was chased back to Kabul by the triumphant Maratha army led by Sadashivrao Bhau and his nephew, the young Vishwasrao.

The book did not go into a **blow-by-blow account** of the battle itself. Rather, it elaborated in detail its consequences for the power struggle in India. Gangadharant read through the account avidly. The style of writing was unmistakably his, yet he was reading the account for the first time!

Their victory in the battle was not only a great **morale booster** to the Marathas but it also established their supremacy in northern India. The East India Company, which had been watching these developments from the sidelines, got the message and temporarily shelved its expansionist programme.

For the Peshwas the immediate result was an increase in the influence of Bhausahab and Vishwasrao who eventually succeeded his father in 1780 A.D. The trouble-maker, Dadasahab, was **relegated to** the background and he eventually retired from state politics.

To its dismay, the East India Company met its match in the new Maratha ruler, Vishwasrao. He and his brother, Madhavrao, combined **political acumen** with valour and systematically expanded their influence all over India. The Company was reduced to pockets of influence near Bombay, Calcutta* and Madras†, just like its European rivals, the Portuguese and the French.

For political reasons, the Peshwas kept the puppet Mughal regime alive in Delhi. In the nineteenth century these **de facto** rulers from Pune were **astute** enough to recognise the importance of the technological age dawning in Europe. They set up their own centres for science and technology. Here, the East India Company saw another opportunity to extend its influence. It offered aid and experts. They were accepted only to make the local centres self-sufficient.

The twentieth century brought about further changes inspired by the West. India moved towards a democracy. By then, the Peshwas had lost their enterprise and they were gradually replaced by democratically elected bodies. The Sultanate at Delhi survived even this transition, largely because it wielded no real influence. The Shahenshah of Delhi was no more than a figurehead to rubber-stamp the 'recommendations' made by the central parliament.

As he read on, Gangadharpant began to appreciate the India he had seen. It was a country that had not been subjected to slavery for the white man; it had learnt to stand on its feet and knew what self-respect was. From a position of strength and for purely commercial reasons, it had allowed the British to retain

* Now known as Kolkata

† Now known as Chennai

Bombay as the sole outpost on the subcontinent. That lease was to expire in the year 2001, according to a treaty of 1908.

Gangadharpant could not help comparing the country he knew with what he was witnessing around him.

But, at the same time, he felt that his investigations were incomplete. How did the Marathas win the battle? To find the answer he must look for accounts of the battle itself.

He went through the books and journals before him. At last, among the books he found one that gave him the clue. It was *Bhauasahebanchi Bakhar*.

Although he seldom relied on the *Bakhars* for historical evidence, he found them entertaining to read. Sometimes, buried in the graphic but **doctored accounts**, he could spot the germ of truth. He found one now in a three-line account of how close Vishwasrao had come to being killed:

... And then Vishwasrao guided his horse to the melee where the elite troops were fighting and he attacked them. And God was merciful. A shot brushed past his ear. Even the difference of a *til* (sesame) would have led to his death.

At eight o'clock the librarian politely reminded the professor that the library was closing for the day. Gangadharpant emerged from his thoughts. Looking around he noticed that he was the only reader left in that magnificent hall.

"I beg your pardon, sir! May I request you to keep these books here for my use tomorrow morning? By the way, when do you open?"

"At eight o'clock, sir." The librarian smiled. Here was a user and researcher right after his heart.

As the professor left the table he shoved some notes into his right pocket. Absent-mindedly, he also shoved the *Bakhar* into his left pocket.

He found a guest house to stay in and had a frugal meal. He then set out for a stroll towards the Azad Maidan.

In the maidan he found a throng moving towards a *pandal*. So, a lecture was to take place. Force of habit took Professor Gaitonde towards the *pandal*. The lecture was in progress, although people kept coming and going. But Professor Gaitonde was not looking at the audience. He was staring at the platform

as if mesmerised. There was a table and a chair but the latter was unoccupied.

The presidential chair unoccupied! The sight stirred him to the depths. Like a piece of iron attracted to a magnet, he swiftly moved towards the chair.

The speaker stopped in mid-sentence, too shocked to continue. But the audience soon found voice.

“Vacate the chair!”

“This lecture series has no chairperson...”

“Away from the platform, mister!”

“The chair is symbolic, don’t you know?”

What nonsense! Whoever heard of a public lecture without a presiding dignitary? Professor Gaitonde went to the mike and **gave vent to** his views. “Ladies and gentlemen, an unchaired lecture is like Shakespeare’s *Hamlet* without the Prince of Denmark. Let me tell you...”

But the audience was in no mood to listen. “Tell us nothing. We are sick of remarks from the chair, of vote of thanks, of long introductions.”

“We only want to listen to the speaker...”

“We abolished the old customs long ago...”

“Keep the platform empty, please...”

But Gangadharant had the experience of speaking at 999 meetings and had faced the Pune audience at its most hostile. He kept on talking.

He soon became a target for a shower of tomatoes, eggs and other objects. But he kept on trying valiantly to correct this sacrilege. Finally, the audience swarmed to the stage to eject him bodily.

And, in the crowd Gangadharant was nowhere to be seen.

“That is all I have to tell, Rajendra. All I know is that I was found in the Azad Maidan in the morning. But I was back in the world I am familiar with. Now, where exactly did I spend those two days when I was absent from here?”

Rajendra was dumbfounded by the narrative. It took him a while to reply.

“Professor, before, just prior to your collision with the truck, what were you doing?” Rajendra asked.

“I was thinking of the catastrophe theory and its implications for history.”

“Right! I thought so!” Rajendra smiled.

“Don’t smile smugly. In case you think that it was just my mind playing tricks and my imagination running amok, look at this.”

And, triumphantly, Professor Gaitonde produced his vital piece of evidence: a page torn out of a book.

Rajendra read the text on the printed page and his face underwent a change. Gone was the smile and in its place came a grave expression. He was visibly moved.

Gangadharant pressed home his advantage. “I had inadvertently slipped the *Bakhar* in my pocket as I left the library. I discovered my error when I was paying for my meal. I had intended to return it the next morning. But it seems that in the melee of Azad Maidan, the book was lost; only this torn-off page remained. And, luckily for me, the page contains vital evidence.”

Rajendra again read the page. It described how Vishwasrao narrowly missed the bullet; and how that event, taken as an omen by the Maratha army, turned the tide in their favour.

“Now look at this.” Gangadharant produced his own copy of *Bhausahabanchi Bakhar*, opened at the relevant page. The account ran thus:

...And then Vishwasrao guided his horse to the melee where the elite troops were fighting, and he attacked them. And God expressed His displeasure. He was hit by the bullet.

“Professor Gaitonde, you have given me food for thought. Until I saw this material evidence, I had simply put your experience down to fantasy. But facts can be stranger than fantasies, as I am beginning to realise.”

“Facts? What are the facts? I am dying to know!” Professor Gaitonde said.

Rajendra motioned him to silence and started pacing the room, obviously under great mental strain. Finally, he turned around and said, “Professor Gaitonde, I will try to rationalise your experience on the basis of two scientific theories as known today. Whether I succeed or not in convincing you of the facts, only you can judge — for you have indeed passed through a fantastic experience: or, more correctly, a catastrophic experience!”

“Please continue, Rajendra! I am all ears,” Professor Gaitonde replied. Rajendra continued pacing as he talked.

“You have heard a lot about the catastrophe theory at that seminar. Let us apply it to the Battle of Panipat. Wars fought face to face on open grounds offer excellent examples of this theory. The Maratha army was facing Abdali’s troops on the field of Panipat. There was no great disparity between the latter’s troops and the opposing forces. Their armour was comparable. So, a lot depended on the leadership and the morale of the troops. The juncture at which Vishwasrao, the son of and heir to the Peshwa, was killed proved to be the turning point. As history has it, his uncle, Bhausahab, rushed into the melee and was never seen again. Whether he was killed in battle or survived is not known. But for the troops at that particular moment, that blow of losing their leaders was crucial. They lost their morale and fighting spirit. There followed an utter rout.

“Exactly, Professor! And what you have shown me on that torn page is the course taken by the battle, when the bullet missed Vishwasrao. A crucial event gone the other way. And its effect on the troops was also the opposite. It boosted their morale and provided just that extra impetus that made all the difference,” Rajendra said.

“Maybe so. Similar statements are made about the Battle of Waterloo, which Napoleon could have won. But we live in a unique world which has a unique history. This idea of ‘it might have been’ is okay for the sake of speculation but not for reality,” Gangadharant said.

“I take issue with you there. In fact, that brings me to my second point which you may find strange; but please hear me out,” Rajendra said.

Gangadharant listened expectantly as Rajendra continued. “What do we mean by reality? We experience it directly with our senses or indirectly via instruments. But is it limited to what we see? Does it have other manifestations?”

“That reality may not be unique has been found from experiments on very small systems—of atoms and their constituent particles. When dealing with such systems the physicist discovered something startling. The behaviour of these systems cannot be predicted definitively even if all the physical laws governing those systems are known.

“Take an example. I fire an electron from a source. Where will it go? If I fire a bullet from a gun in a given direction at a

given speed, I know where it will be at a later time. But I cannot make such an assertion for the electron. It may be here, there, anywhere. I can at best quote odds for it being found in a specified location at a specified time.”

“The lack of determinism in quantum theory! Even an ignoramus historian like me has heard of it,” Professor Gaitonde said.

“So, imagine many world pictures. In one world the electron is found here, in another it is over there. In yet another it is in a still different location. Once the observer finds where it is, we know which world we are talking about. But all those alternative worlds could exist just the same.” Rajendra paused to marshall his thoughts.

“But is there any contact between those many worlds?” Professor Gaitonde asked.

“Yes and no! Imagine two worlds, for example. In both an electron is orbiting the nucleus of an atom...”

“Like planets around the sun...” Gangadharant interjected.

“Not quite. We know the precise trajectory of the planet. The electron could be orbiting in any of a large number of specified states. These states may be used to identify the world. In state no.1 we have the electron in a state of higher energy. In state no.2 it is in a state of lower energy. It can make a jump from high to low energy and send out a pulse of radiation. Or a pulse of radiation can knock it out of state no.2 into state no.1. Such transitions are common in microscopic systems. What if it happened on a macroscopic level?” Rajendra said.

“I get you! You are suggesting that I made a transition from one world to another and back again?” Gangadharant asked.

“Fantastic though it seems, this is the only explanation I can offer. My theory is that catastrophic situations offer radically different alternatives for the world to proceed. It seems that so far as reality is concerned all alternatives are viable but the observer can experience only one of them at a time.

“By making a transition, you were able to experience two worlds although one at a time. The one you live in now and the one where you spent two days. One has the history we know, the other a different history. The separation or bifurcation took place in the Battle of Panipat. You neither travelled to the past nor to the future. You were in the present but experiencing a different world. Of course, by the same token there must be many more different worlds arising out of bifurcations at different points of time.”

As Rajendra concluded, Gangadharpant asked the question that was beginning to bother him most. “But why did I make the transition?”

“If I knew the answer I would solve a great problem. Unfortunately, there are many unsolved questions in science and this is one of them. But that does not stop me from guessing.” Rajendra smiled and proceeded, “You need some interaction to cause a transition. Perhaps, at the time of the collision you were thinking about the catastrophe theory and its role in wars. Maybe you were wondering about the Battle of Panipat. Perhaps, the neurons in your brain acted as a trigger.”

“A good guess. I was indeed wondering what course history would have taken if the result of the battle had gone the other way,” Professor Gaitonde said. “That was going to be the topic of my thousandth presidential address.”

“Now you are in the happy position of recounting your real life experience rather than just speculating,” Rajendra laughed. But Gangadharpant was grave.

“No, Rajendra, my thousandth address was made on the Azad Maidan when I was so rudely interrupted. No. The Professor Gaitonde who disappeared while defending his chair on the platform will now never be seen presiding at another meeting — I have conveyed my regrets to the organisers of the Panipat seminar.”

Understanding the text

- I. Tick the statements that are true.
 1. The story is an account of real events.
 2. The story hinges on a particular historical event.
 3. Rajendra Deshpande was a historian.
 4. The places mentioned in the story are all imaginary.
 5. The story tries to relate history to science.
- II. Briefly explain the following statements from the text.
 1. “You neither travelled to the past nor the future. You were in the present experiencing a different world.”
 2. “You have passed through a fantastic experience: or more correctly, a catastrophic experience.”
 3. Gangadharpant could not help comparing the country he knew with what he was witnessing around him.

4. "The lack of determinism in quantum theory!"
5. "You need some interaction to cause a transition."

Talking about the text

1. Discuss the following statements in groups of two pairs, each pair in a group taking opposite points of view.
 - (i) A single event may change the course of the history of a nation.
 - (ii) Reality is what is directly experienced through the senses.
 - (iii) The methods of inquiry of history, science and philosophy are similar.
2.
 - (i) The story is called 'The Adventure'. Compare it with the adventure described in 'We're Not Afraid to Die...'
 - (ii) Why do you think Professor Gaitonde decided never to preside over meetings again?

Thinking about language

1. In which language do you think Gangadharpant and Khan Sahib talked to each other? Which language did Gangadharpant use to talk to the English receptionist?
2. In which language do you think *Bhauasahebanchi Bakhar* was written?
3. There is mention of three communities in the story: the Marathas, the Mughals, the Anglo-Indians. Which language do you think they used within their communities and while speaking to the other groups?
4. Do you think that the ruled always adopt the language of the ruler?

Working with words

- I. Tick the item that is closest in meaning to the following phrases.
 1. to take issue with
 - (i) to accept
 - (ii) to discuss
 - (iii) to disagree
 - (iv) to add

2. to give vent to
 - (i) to express
 - (ii) to emphasise
 - (iii) suppress
 - (iv) dismiss
3. to stand on one's feet
 - (i) to be physically strong
 - (ii) to be independent
 - (iii) to stand erect
 - (iv) to be successful
4. to be wound up
 - (i) to become active
 - (ii) to stop operating
 - (iii) to be transformed
 - (iv) to be destroyed
5. to meet one's match
 - (i) to meet a partner who has similar tastes
 - (ii) to meet an opponent
 - (iii) to meet someone who is equally able as oneself
 - (iv) to meet defeat

II. Distinguish between the following pairs of sentences.

1. (i) He was *visibly* moved.
(ii) He was *visually* impaired.
2. (i) Green and black stripes were used *alternately*.
(ii) Green stripes could be used or *alternatively* black ones.
3. (i) The team played the two matches *successfully*.
(ii) The team played two matches *successively*.
4. (i) The librarian spoke *respectfully* to the learned scholar.
(ii) You will find the historian and the scientist in the archaeology and natural science sections of the museum *respectively*.

Noticing form

The story deals with unreal and hypothetical conditions. Some of the sentences used to express this notion are given below:

1. *If I fire* a bullet from a gun in a given direction at a given speed, I know where it *will be* at a later time.
2. *If I knew* the answer *I would solve* a great problem.
3. *If he himself were* dead in this world, what guarantee had he that his son *would be alive*.
4. What course *would history have taken* if the battle *had gone* the other way?

Notice that in an unreal condition, it is clearly expected that the condition will not be fulfilled.

Things to do

- I. Read the following passage on the Catastrophe Theory downloaded from the Internet.

Originated by the French mathematician, Rene Thom, in the 1960s, catastrophe theory is a special branch of dynamical systems theory. It studies and classifies phenomena characterised by sudden shifts in behaviour arising from small changes in circumstances.

Catastrophes are bifurcations between different equilibria, or fixed point attractors. Due to their restricted nature, catastrophes can be classified on the basis of how many control parameters are being simultaneously varied. For example, if there are two controls, then one finds the most common type, called a 'cusp' catastrophe. If, however, there are more than five controls, there is no classification.

Catastrophe theory has been applied to a number of different phenomena, such as the stability of ships at sea and their capsizing, bridge collapse, and, with some less convincing success, the fight-or-flight behaviour of animals and prison riots.

- II. Look up the Internet or an encyclopedia for information on the following theories.
- (i) Quantum theory
 - (ii) Theory of relativity
 - (iii) Big Bang theory
 - (iv) Theory of evolution

Notes

Understanding the text ■

- True/false items to check inferential comprehension
- Explaining statements from the text

Talking about the text ■

- Discussing approaches of various disciplines to knowledge inquiry (across the curriculum)
- Cross-text reference

Thinking about language ■

- Inter-community communication through common languages
- Reference to languages of different disciplines
- Political domination and language imposition (discuss)

Working with words ■

- Idiomatic expressions
- Distinction between frequently misused word forms: respectively/ respectfully

Noticing form ■

Conditional sentences for unreal and hypothetical conditions

Things to do ■

Finding out about popular scientific theories (real-life reading)

8 Silk Road

Nick Middleton

*Notice these expressions in the text.
Infer their meaning from the context.*

- ◆ ducking back
- ◆ manoeuvres
- ◆ billowed
- ◆ swathe
- ◆ cairn of rocks
- ◆ careered down
- ◆ salt flats

A **FLAWLESS** half-moon floated in a perfect blue sky on the morning we said our goodbyes. Extended banks of cloud like long French loaves glowed pink as the sun emerged to splash the distant mountain tops with a rose-tinted blush. Now that we were leaving Ravu, Lhamo said she wanted to give me a farewell present. One evening I'd told her through Daniel that I was heading towards Mount Kailash to complete the *kora*, and she'd said that I ought to get some warmer clothes. After **ducking back** into her tent, she emerged carrying one of the long-sleeved sheepskin coats that all the men wore. Tsetan sized me up as we clambered into his car. "Ah, yes," he declared, "*drokba*, sir."

We took a short cut to get off the Changtang. Tsetan knew a route that would take us south-west, almost directly towards Mount Kailash. It involved crossing several fairly high mountain passes, he said. "But no problem, sir", he assured us, "if there is no snow." What was the likelihood of that I asked. "Not knowing, sir, until we get there."

From the gently rolling hills of Ravu, the short cut took us across vast open plains with nothing in them except a few gazelles



Sketch of Mount Kailash

that would look up from nibbling the arid pastures and frown before bounding away into the void. Further on, where the plains became more stony than grassy, a great herd of wild ass came into view. Tsetan told us we were approaching them long before they appeared. “*Kyang*,” he said, pointing towards a far-off pall of dust. When we drew near, I could see the herd galloping en masse, wheeling and turning in tight formation as if they were practising **manoeuvres** on some predetermined course. Plumes of dust **billowed** into the crisp, clean air.

As hills started to push up once more from the rocky wilderness, we passed solitary *drokbas* tending their flocks. Sometimes men, sometimes women, these well-wrapped figures would pause and stare at our car, occasionally waving as we passed. When the track took us close to their animals, the sheep would take evasive action, veering away from the speeding vehicle.

We passed nomads’ dark tents pitched in splendid isolation, usually with a huge black dog, a Tibetan mastiff, standing guard. These beasts would cock their great big heads when they became aware of our approach and fix us in their sights. As we continued to draw closer, they would explode into action, speeding directly towards us, like a bullet from a gun and nearly as fast.

These shaggy monsters, blacker than the darkest night, usually wore bright red collars and barked furiously with massive jaws. They were completely fearless of our vehicle, shooting straight into our path, causing Tsetan to brake and swerve. The

dog would make chase for a hundred metres or so before easing off, having seen us off the property. It wasn't difficult to understand why ferocious Tibetan mastiffs became popular in China's imperial courts as hunting dogs, brought along the Silk Road in ancient times as tribute from Tibet.

By now we could see snow-capped mountains gathering on the horizon. We entered a valley where the river was wide and mostly clogged with ice, brilliant white and glinting in the sunshine. The trail hugged its bank, twisting with the meanders as we gradually gained height and the valley sides closed in.

The turns became sharper and the ride bumpier, Tsetan now in third gear as we continued to climb. The track moved away from the icy river, labouring through steeper slopes that sported big rocks daubed with patches of bright orange lichen. Beneath the rocks, hunks of snow clung on in the near-permanent shade. I felt the pressure building up in my ears, held my nose, snorted and cleared them. We struggled round another tight bend and Tsetan stopped. He had opened his door and jumped out of his seat before I realised what was going on. "Snow," said Daniel as he too exited the vehicle, letting in a breath of cold air as he did so.

A **swathe** of the white stuff lay across the track in front of us, stretching for maybe fifteen metres before it petered out and the dirt trail reappeared. The snow continued on either side of us, smoothing the abrupt bank on the upslope side. The bank was too steep for our vehicle to scale, so there was no way round the snow patch. I joined Daniel as Tsetan stepped on to the encrusted snow and began to slither and slide forward, stamping his foot from time to time to ascertain how sturdy it was. I looked at my wristwatch. We were at 5,210 metres above sea level.

The snow didn't look too deep to me, but the danger wasn't its depth, Daniel said, so much as its icy top layer. "If we slip off, the car could turn over," he suggested, as we saw Tsetan grab handfuls of dirt and fling them across the frozen surface. We both pitched in and, when the snow was spread with soil, Daniel and I stayed out of the vehicle to lighten Tsetan's load. He backed up and drove towards the dirty snow, eased the car on to its icy surface and slowly drove its length without apparent difficulty.

Ten minutes later, we stopped at another blockage. "Not good, sir," Tsetan announced as he jumped out again to survey the scene. This time he decided to try and drive round the snow.

The slope was steep and studded with major rocks, but somehow Tsetan negotiated them, his four-wheel drive vehicle lurching from one obstacle to the next. In so doing he cut off one of the hairpin bends, regaining the trail further up where the snow had not drifted.

I checked my watch again as we continued to climb in the bright sunshine. We crept past 5,400 metres and my head began to throb horribly. I took gulps from my water bottle, which is supposed to help a rapid ascent.

We finally reached the top of the pass at 5,515 metres. It was marked by a large **cairn of rocks** festooned with white silk scarves and ragged prayer flags. We all took a turn round the cairn, in a clockwise direction as is the tradition, and Tsetan checked the tyres on his vehicle. He stopped at the petrol tank and partially unscrewed the top, which emitted a loud hiss. The lower atmospheric pressure was allowing the fuel to expand. It sounded dangerous to me. "Maybe, sir," Tsetan laughed "but no smoking."

My headache soon cleared as we **careered down** the other side of the pass. It was two o'clock by the time we stopped for lunch. We ate hot noodles inside a long canvas tent, part of a workcamp erected beside a dry salt lake. The plateau is pockmarked with **salt flats** and brackish lakes, vestiges of the Tethys Ocean which bordered Tibet before the great continental collision that lifted it skyward. This one was a hive of activity, men with pickaxes and shovels trudging back and forth in their long sheepskin coats and salt-encrusted boots. All wore sunglasses against the glare as a steady stream of blue trucks emerged from the blindingly white lake laden with piles of salt.

By late afternoon we had reached the small town of Hor, back on the main east-west highway that followed the old trade route from Lhasa to Kashmir. Daniel, who was returning to Lhasa, found a ride in a truck so Tsetan and I bade him farewell outside a tyre-repair shop. We had suffered two punctures in quick succession on the drive down from the salt lake and Tsetan was eager to have them fixed since they left him with no spares. Besides, the second tyre he'd changed had been replaced by one that was as smooth as my bald head.

Hor was a grim, miserable place. There was no vegetation whatsoever, just dust and rocks, liberally scattered with years of accumulated refuse, which was unfortunate given that the town sat on the shore of Lake Manasarovar, Tibet's most

venerated stretch of water. Ancient Hindu and Buddhist cosmology pinpoints Manasarovar as the source of four great Indian rivers: the Indus, the Ganges, the Sutlej and the Brahmaputra. Actually only the Sutlej flows from the lake, but the headwaters of the others all rise nearby on the flanks of Mount Kailash. We were within striking distance of the great mountain and I was eager to forge ahead.

But I had to wait. Tsetan told me to go and drink some tea in Hor's only cafe which, like all the other buildings in town, was constructed from badly painted concrete and had three broken windows. The good view of the lake through one of them helped to compensate for the draught.

I was served by a Chinese youth in military uniform who spread the grease around on my table with a filthy rag before bringing me a glass and a thermos of tea.

Half an hour later, Tsetan relieved me from my solitary confinement and we drove past a lot more rocks and rubbish westwards out of town towards Mount Kailash.

My experience in Hor came as a stark contrast to accounts I'd read of earlier travellers' first encounters with Lake Manasarovar. Ekai Kawaguchi, a Japanese monk who had arrived there in 1900, was so moved by the sanctity of the lake that he burst into tears. A couple of years later, the hallowed waters had a similar effect on Sven Hedin, a Swede who wasn't prone to sentimental outbursts.

It was dark by the time we finally left again and after 10.30 p.m. we drew up outside a guest house in Darchen for what turned out to be another troubled night. Kicking around in the open-air rubbish dump that passed for the town of Hor had set off my cold once more, though if truth be told it had never quite disappeared with my herbal tea. One of my nostrils was blocked again and as I lay down to sleep, I wasn't convinced that the other would provide me with sufficient oxygen. My watch told me I was at 4,760 metres. It wasn't much higher than Ravu, and there I'd been gasping for oxygen several times every night. I'd grown accustomed to these nocturnal disturbances by now, but they still scared me.

Tired and hungry, I started breathing through my mouth. After a while, I switched to single-nostril power which seemed to be admitting enough oxygen but, just as I was drifting off, I woke up abruptly. Something was wrong. My chest felt

strangely heavy and I sat up, a movement that cleared my nasal passages almost instantly and relieved the feeling in my chest. Curious, I thought.

I lay back down and tried again. Same result. I was on the point of disappearing into the land of nod when something told me not to. It must have been those emergency electrical impulses again, but this was not the same as on previous occasions. This time, I wasn't gasping for breath, I was simply not allowed to go to sleep.

Sitting up once more immediately made me feel better. I could breathe freely and my chest felt fine. But as soon as I lay down, my sinuses filled and my chest was odd. I tried propping myself upright against the wall, but now I couldn't manage to relax enough to drop off. I couldn't put my finger on the reason, but I was afraid to go to sleep. A little voice inside me was saying that if I did I might never wake up again. So I stayed awake all night.

Tsetan took me to the Darchen medical college the following morning. The medical college at Darchen was new and looked like a monastery from the outside with a very solid door that led into a large courtyard. We found the consulting room which was dark and cold and occupied by a Tibetan doctor who wore none of the paraphernalia that I'd been expecting. No white coat, he looked like any other Tibetan with a thick pullover and a woolly hat. When I explained my sleepless symptoms and my sudden aversion to lying down, he shot me a few questions while feeling the veins in my wrist.

"It's a cold," he said finally through Tsetan. "A cold and the effects of altitude. I'll give you something for it."

I asked him if he thought I'd recover enough to be able to do the *kora*. "Oh yes," he said, "you'll be fine."

I walked out of the medical college clutching a brown envelope stuffed with fifteen screws of paper. I had a five-day course of Tibetan medicine which I started right away. I opened an after-breakfast package and found it contained a brown powder that I had to take with hot water. It tasted just like cinnamon. The contents of the lunchtime and bedtime packages were less obviously identifiable. Both contained small, spherical brown pellets. They looked suspiciously like sheep dung, but of course I took them. That night, after my first full day's course, I slept very soundly. Like a log, not a dead man.

Once he saw that I was going to live Tsetan left me, to return to Lhasa. As a Buddhist, he told me, he knew that it didn't really matter if I passed away, but he thought it would be bad for business.

Darchen didn't look so horrible after a good night's sleep. It was still dusty, partially derelict and punctuated by heaps of rubble and refuse, but the sun shone brilliantly in a clear blue sky and the outlook across the plain to the south gave me a vision of the Himalayas, commanded by a huge, snow-capped mountain, Gurla Mandhata, with just a wisp of cloud suspended over its summit.

The town had a couple of rudimentary general stores selling Chinese cigarettes, soap and other basic provisions, as well as the usual strings of prayer flags. In front of one, men gathered in the afternoon for a game of pool, the battered table looking supremely incongruous in the open air, while nearby women washed their long hair in the icy water of a narrow brook that babbled down past my guest house. Darchen felt relaxed and unhurried but, for me, it came with a significant drawback. There were no pilgrims.

I'd been told that at the height of the pilgrimage season, the town was bustling with visitors. Many brought their own accommodation, enlarging the settlement round its edges as they set up their tents which spilled down on to the plain. I'd timed my arrival for the beginning of the season, but it seemed I was too early.

One afternoon I sat pondering my options over a glass of tea in Darchen's only café. After a little consideration, I concluded they were severely limited. Clearly I hadn't made much progress with my self-help programme on positive thinking.

In my defence, it hadn't been easy with all my sleeping difficulties, but however I looked at it, I could only wait. The pilgrimage trail was well-trodden, but I didn't fancy doing it alone. The *kora* was seasonal because parts of the route were liable to blockage by snow. I had no idea whether or not the snow had cleared, but I wasn't encouraged by the chunks of dirty ice that still clung to the banks of Darchen's brook. Since Tsetan had left, I hadn't come across anyone in Darchen with enough English to answer even this most basic question.

Until, that is, I met Norbu. The café was small, dark and cavernous, with a long metal stove that ran down the middle. The walls and ceiling were wreathed in sheets of multi-coloured

plastic, of the striped variety— broad blue, red and white—that is made into stout, voluminous shopping bags sold all over China, and in many other countries of Asia as well as Europe. As such, plastic must rate as one of China's most successful exports along the Silk Road today.

The café had a single window beside which I'd taken up position so that I could see the pages of my notebook. I'd also brought a novel with me to help pass the time.

Norbu saw my book when he came in and asked with a gesture if he could sit opposite me at my rickety table. "You English?" he enquired, after he'd ordered tea. I told him I was, and we struck up a conversation.

I didn't think he was from those parts because he was wearing a windcheater and metal-rimmed spectacles of a Western style. He was Tibetan, he told me, but worked in Beijing at the Chinese Academy of Social Sciences, in the Institute of Ethnic Literature. I assumed he was on some sort of fieldwork.

"Yes and no," he said. "I have come to do the *kora*." My heart jumped. Norbu had been writing academic papers about the Kailash *kora* and its importance in various works of Buddhist literature for many years, he told me, but he had never actually done it himself.

When the time came for me to tell him what brought me to Darchen, his eyes lit up. "We could be a team," he said excitedly. "Two academics who have escaped from the library." Perhaps my positive-thinking strategy was working after all.

My initial relief at meeting Norbu, who was also staying in the guest house, was tempered by the realisation that he was almost as ill-equipped as I was for the pilgrimage. He kept telling me how fat he was and how hard it was going to be. "Very high up," he kept reminding me, "so tiresome to walk." He wasn't really a practising Buddhist, it transpired, but he had enthusiasm and he was, of course, Tibetan.

Although I'd originally envisaged making the trek in the company of devout believers, on reflection I decided that perhaps Norbu would turn out to be the ideal companion. He suggested we hire some yaks to carry our luggage, which I interpreted as a good sign, and he had no intention of prostrating himself all round the mountain. "Not possible," he cried, collapsing across the table in hysterical laughter. It wasn't his style, and anyway his tummy was too big.

Understanding the text

- I. Give reasons for the following statements.
1. The article has been titled 'Silk Road.'
 2. Tibetan mastiffs were popular in China's imperial courts.
 3. The author's experience at Hor was in stark contrast to earlier accounts of the place.
 4. The author was disappointed with Darchen.
 5. The author thought that his positive thinking strategy worked well after all.
- II. Briefly comment on
1. The purpose of the author's journey to Mount Kailash.
 2. The author's physical condition in Darchen.
 3. The author's meeting with Norbu.
 4. Tsetan's support to the author during the journey.
 5. "As a Buddhist, he told me, he knew that it didn't really matter if I passed away, but he thought it would be bad for business."

Talking about the text

Discuss in groups of four

1. The sensitive behaviour of hill-folk.
2. The reasons why people willingly undergo the travails of difficult journeys.
3. The accounts of exotic places in legends and the reality.

Thinking about language

1. Notice the kind of English Tsetan uses while talking to the author. How do you think he picked it up?
2. What do the following utterances indicate?
 - (i) "I told her, *through* Daniel ..."
 - (ii) "It's a cold," he said finally *through* Tsetan.

3. Guess the meaning of the following words.

<i>kora</i>	<i>drokba</i>	<i>kyang</i>
-------------	---------------	--------------

In which language are these words found?

Working with words

1. The narrative has many phrases to describe the scenic beauty of the mountainside like:

A flawless half-moon floated in a perfect blue sky.

Scan the text to locate other such picturesque phrases.

2. Explain the use of the adjectives in the following phrases.
- shaggy monsters
 - brackish lakes
 - rickety table
 - hairpin bend
 - rudimentary general stores

Noticing form

- The account has only a few passive voice sentences. Locate them. In what way does the use of active voice contribute to the style of the narrative.
- Notice this construction: Tsetan was eager to have them fixed. Write five sentences with a similar structure.

Things to do

“The plateau is pockmarked with salt flats and brackish lakes, vestiges of the Tethys Ocean which bordered Tibet before the continental collision that lifted it skyward.”

Given below is an extract from an account of the Tethys Ocean downloaded from the Internet. Go online, key in Tethys Ocean in Google search and you will find exhaustive information on this geological event. You can also consult an encyclopedia.

Today, India, Indonesia and the Indian Ocean cover the area once occupied by the Tethys Ocean. Turkey, Iraq, and Tibet sit on the land once known as Cimmeria. Most of the floor of the Tethys Ocean disappeared under Cimmeria and Laurasia. We

only know that Tethys existed because geologists like Suess have found fossils of ocean creatures in rocks in the Himalayas. So, we know those rocks were underwater, before the Indian continental shelf began pushing upward as it smashed into Cimmeria. We can see similar geologic evidence in Europe, where the movement of Africa raised the Alps.

Notes

A travelogue presenting a panoramic view of Mt Kailash.

Understanding the text ■

- Factual comprehension
- Author's adventurous experiences while scaling the hilly terrain

Talking about the text ■

- Lifestyle of hill-folk
- Author's description of exotic places

Thinking about language ■

- English spoken by guides
- Communicating with strangers
- Guessing the meanings of words from other languages from the context

Working with words ■

- Noticing picturesque phrases
- Use of uncommon adjectives

Noticing form ■

Predominant use of active voice as a contributor to the style of narration

Things to do ■

Getting information about geological formations from the Internet/encyclopedia

Father to Son

Elizabeth Jennings

I do not understand this child
Though we have lived together now
In the same house for years. I know
Nothing of him, so try to build
Up a relationship from how
He was when small. Yet have I killed

The seed I spent or sown it where
The land is his and none of mine?
We speak like strangers, there's no sign
Of understanding in the air.
This child is built to my design
Yet what he loves I cannot share.

Silence surrounds us. I would have
Him prodigal, returning to
His father's house, the home he knew,
Rather than see him make and move
His world. I would forgive him too,
Shaping from sorrow a new love.

Father and son, we both must live
On the same globe and the same land,
He speaks: I cannot understand
Myself, why anger grows from grief.
We each put out an empty hand,
Longing for something to forgive.

Think it out

1. Does the poem talk of an exclusively personal experience or is it fairly universal?
2. How is the father's helplessness brought out in the poem?
3. Identify the phrases and lines that indicate distance between father and son.
4. Does the poem have a consistent rhyme scheme?

Notes

The poem is autobiographical in nature and describes the relationship between a father and his son.

Understanding the poem

Questions are based on

- the universality of the experience described
- phrases in the poem
- rhyme scheme in the poem

Writing Skills

Note-making
Summarising
Sub-titling
Essay-writing
Letter-writing
Creative Writing

I know what I want to say, but I don't know how to say it.

– a student

To be able to write effectively the student needs to

- ◆ understand the significance and purpose of writing
- ◆ develop coherence in writing
- ◆ understand and employ cohesive devices
- ◆ have relative command of grammar, spelling and punctuation.

1 Note-making

NOTE-MAKING is an important study skill. It also helps us at work. We need to draw the main points of the material we read as it is difficult to remember large chunks of information. Let us begin with an example.

Study the following passage carefully

Pheasants are shy, charming birds known for their brilliant plumage. These beautiful birds occupy an important niche in nature's scheme of things. Of the 900 bird species and 155 families, the pheasants belong to the order *Galliformes* and family *Phasianidae*. The *Galliformes* are known as game birds and this includes, pheasants, partridges, quails, grouse, francolins, turkeys and megapodes.

There are 51 species of pheasants in the world and these are shown in the identification chart brought out by the Environment Society of India (ESI). The purpose of this chart is to create awareness among members of the school eco-clubs under the National Green Corps (NGC) of the Ministry of Environment and Forests, Government of India.

Except for the Congo Peafowl, all the other pheasants are from Asia. Scientists believe that all pheasants originated from the Himalayas, and then scattered into Tibet, China, Myanmar, South and South East Asian countries as well as the Caucasus Mountains. The jungle fowl and the peafowl spread to South India and Sri Lanka long before the early settlers established themselves in the Indo-Gangetic plain.

About a third of all the pheasants in the world are found in India. The male blue peafowl (the peacock) is the best known member of the pheasant family and is India's national bird. It occupies a prominent place in India's art, culture and folklore.

STEP 1

Notice that the important information has been underlined.

Pheasants are shy, charming birds known for their brilliant plumage. These beautiful birds occupy an important niche in nature's scheme of things. Of the 900 bird species and 155 families, the pheasants belong to the order Galliformes and family Phasinidae. The Galliformes are known as game birds and this includes, pheasants, partridges, quails, grouse, francolins, turkeys and megapodes.

There are 51 species of pheasants in the world and these are shown in the identification chart brought out by the Environment Society of India (ESI). The purpose of this chart is to create awareness among members of the school eco-clubs under the National Green Corps (NGC) of the Ministry of Environment and Forests, Government of India.

Except for the Congo Peafowl, all the other pheasants are from Asia. Scientists believe that all pheasants originated from the Himalayas, and then scattered into Tibet, China, Myanmar, South and South East Asian countries as well as the Caucasus Mountains. The jungle fowl and the peafowl spread to South India and Sri Lanka long before the early settlers established themselves in the Indo-Gangetic plain.

About a third of all the pheasants in the world are found in India. The male blue peafowl (the peacock) is the best known member of the pheasant family and is India's national bird. It occupies a prominent place in India's art, culture and folklore.

STEP 2

Read the passage again asking yourself questions and answering them as you read.

- What is the passage about? — Pheasants
- Where found? — Asia; particularly India (1/3 of total population)
- Origin? — Himalayas
- Time? — Long before Indo-Gangetic plain settlements.
- Which group of birds? — Order: *Galliformes* (game birds); Family — *Phasinidae*

- How many species? — 51
- What is the source of information? — ESI chart
- What is the purpose of the ESI chart? — Create awareness among school eco-clubs under NGC
- Which is the best known member? — Peacock, India's national bird

STEP 3

With the help of the answers note down the main points. Write the points without full forms of the verbs.

- Pheasants — shy birds with bright plumage found largely in Asia, especially India
- Origin in the Himalayas and spread in China, Myanmar, South and SE Asia.
- Order: *Galliformes* — game birds; Family: *Phasianidae*
- No. of species: 51 (ESI chart)
- Purpose of ESI chart — Creating awareness among school eco-clubs under NGC.
- Peacock — India's national bird, member of this family, represented in Indian art, culture and folklore.

Notice

- Two or three related ideas can be combined into one point.
- Use of colons
- Use of the long dash

STEP 4

Now go over the facts and number them.

- This is only to analyse the process of note-making. With practice you will be able to reach Step 4 immediately, going through Steps 2 and 3 mentally.

STEP 5

Finally we go over the facts and number them again.

Read carefully the characteristics of good notes which are given below.

1. (i) Notes should be short. They should identify the main point.
 (ii) They list information in what is called 'note form'.
 (iii) They are written only in phrases; not sentences.
2. (i) Information is logically divided and subdivided by the use of figures/letters.
 (ii) The divisions are made like this:

Main sections	:	1, 2, 3, etc.
Sub-sections	:	(i), (ii), (iii), etc.
Sub-sub-sections	:	(a), (b), (c), etc.
3. Another common method is the 'decimal' system.

Main sections	:	1, 2, 3, etc.
Sub-sections	:	1.1, 1.2, 1.3, etc.
Sub-sub-sections	:	1.1.1, 1.1.2, 1.1.3, 1.2.1, 1.2.2, etc.
4. Abbreviations and symbols are freely used. Articles, prepositions and conjunctions are omitted.
5. Notes must make sense when they are read again otherwise they will be of no use.

Now read the following text.

The energy stored in coal and petroleum originally came to the earth from the sun. The bulk of the present-day supplies was laid down some 200 to 600 million years ago, when tropical conditions were widespread. Lush, swampy forests produced huge trees; warm coastal seas swarmed with microscopic forms of life. When these organisms died, much of their tissue was recycled as it is today — through scavenging and decay. But a significant amount of dead plant and animal material was covered with mud, which prevented complete decomposition.

With the passage of time, layer upon layer of the fine sediment was deposited over the once-living material; the sheer weight turned the sediments to rock. Sandwiched between the layers, both coal and petroleum were produced and preserved under pressure. Coal was formed mostly of giant fern-like plants that have only small counterparts today. Coal may still be forming here and there on earth, but conditions are not right for the production of significant quantities.

1. Underline the important words and phrases.
2. Write down points without fully expanded verbs, numbering them as you do.
3. Combine related points.
4. Group related points.
5. Change the verbs to nouns and begin points with them.
6. Number the points.

After you have finished check with the notes given below.

- Storage of energy from sun in coal and petroleum
- Deposit of bulk of supplies 200 – 600 million years ago
- Teeming life in tropical conditions
- Death of life forms, leading to recycling through decay
- Prevention of total decomposition by considerable dead plants, animals being covered with mud
- Solidification of sediment leading to rock-formation over time
- Production of coal, petroleum by compression of organic matter between rocks
- Unsuitability of present-day conditions for coal-formation

2 Summarising

SUMMARISING follows note-making. The purpose of note-making is usually for one's own personal reference. If the main points are to be reported we present a summary. It is not as severely shortened as note-making.

Summarising is the selection and paraphrasing of all important information of the original source. This is done by analysing the paragraphs/passage in order to formulate a plan of writing.

The process of summarising would involve the steps followed in note-making:

1. underlining important ideas
2. writing them down, abridging the verbs
3. avoiding examples, explanations, repetition.

However, instead of nominalising the points (changing verbs into nouns), we expand the points into full sentences and link them using suitable connectors. We need to be precise in our expression. The summary will contain all the main ideas of the original. Practice in using one word for many will help.

For example:

- Children *who show intelligence far beyond their age* often turn out to be mediocre in adult life.

or

Precocious children often turn out to be mediocre in adult life.

- Her *genius was marked by excellence in the various arts, languages and science.*

or

She was a *versatile* genius.

Now read the following text underlining important words as you go along.

Soybeans belong to the legume family. The beans are the seeds of the leguminous soybean plant. They can be grown on a variety of soils and in a wide range of climates. Soybeans are versatile as they can be used as whole beans, soy sprouts, or processed as a variety of food items, such as soy milk, tofu, tempeh, textured vegetable protein, miso, soy sauce, soy oil and margarine, and soy dairy alternatives. They are also used for making candles and bio-diesel.

Soy is an excellent source of high quality protein; is low in saturated fats and is cholesterol-free. It is also rich in vitamins, especially Vitamin B complex, minerals such as magnesium, calcium, iron, potassium and copper and also fibres. In recent times it has been highly recommended because of its ability to lower the levels of Low Density Lipoprotein (LDL), a bad cholesterol. The Food and Drug Administration (FDA), has confirmed that foods containing soy protein are likely to reduce the risk of coronary heart disease.

An easy way to take soy is as soymilk now available with added flavour. Soymilk does not contain lactose (milk sugar) and can be drunk by those who are allergic to normal milk. To get soymilk, soybeans are soaked in water, ground and then strained. If you don't mind the trouble, you can also make it at home. (225 words).

Now note down the important points.

- Soybeans are the seeds of the soybean plant of the legume family.
- They grow in a variety of soils and climates.
- They can be used in various forms — beans, sprouts and a variety of food items.
- They are also used to make candles and bio-diesel.
- They are a source of high quality protein, vitamins, minerals and fibres. They are low in fat content and cholesterol. They can lower LDL levels and reduces risk of coronary heart disease.
- Soymilk, lactose-free, is available as flavoured milk and can be drunk by those allergic to ordinary milk and can also be

made at home by soaking the beans, grinding them and straining the water. (111 words)

A summary is usually one-third the length of the original passage. This is about half.

Now think of what we can omit to make the summary more brief as shown below.

The soybean leguminous plant which grows in all kinds of soil and climate yields beans, sprouts and a variety of processed food items and dairy alternatives and is also used to make candles and bio-diesel.

Rich in protein, vitamins, minerals and fibres, it has a low fat and cholesterol content. It lowers LDL levels and reduces the risk of coronary heart disease.

Soymilk which is lactose-free is available as flavoured milk and agrees with people allergic to ordinary milk. It can be made at home by soaking, grinding and straining soybean. (90 words)

Try reducing it further to about 72 words.

Soybean, a legume, growing in a variety of soil and climatic conditions, yields beans, sprouts and a variety of food items and is used in making candles and bio-diesel.

Rich in protein, vitamins, minerals and fibres, it is low in cholesterol and fat. It lowers LDL levels and reduces the risk of coronary heart disease. Soymilk, lactose-free, is available flavoured and taken by people allergic to milk. It can also be made at home. (74 words)

Notice that we have phrases in apposition: 'a legume', between commas; present participles: 'growing' to effect reduction. Instead of 'it is rich in...' we have used 'rich in...' and postponed the main verb in the sentence. Almost all the main points have been covered.

Read the text below and summarise it.

Green Sahara

The Great Desert Where Hippos Once Wallowed

The Sahara sets a standard for dry land. It's the world's largest desert. Relative humidity can drop into the low single digits. There are places where it rains only about once a

century. There are people who reach the end of their lives without ever seeing water come from the sky.

Yet beneath the Sahara are vast aquifers of fresh water, enough liquid to fill a small sea. It is fossil water, a treasure laid down in prehistoric times, some of it possibly a million years old. Just 6,000 years ago, the Sahara was a much different place.

It was green. Prehistoric rock art in the Sahara shows something surprising: hippopotamuses, which need year-round water.

“We don’t have much evidence of a tropical paradise out there, but we had something perfectly liveable,” says Jennifer Smith, a geologist at Washington University in St Louis.

The green Sahara was the product of the migration of the paleo-monsoon. In the same way that ice ages come and go, so too do monsoons migrate north and south. The dynamics of earth’s motion are responsible. The tilt of the earth’s axis varies in a regular cycle — sometimes the planet is more tilted towards the sun, sometimes less so. The axis also wobbles like a spinning top. The date of the earth’s perihelion — its closest approach to the sun — varies in a cycle as well.

At times when the Northern Hemisphere tilts sharply towards the sun and the planet makes its closest approach, the increased blast of sunlight during the north’s summer months can cause the African monsoon (which currently occurs between the Equator and roughly 17°N latitude) to shift to the north as it did 10,000 years ago, inundating North Africa.

Around 5,000 years ago the monsoon shifted dramatically southward again. The prehistoric inhabitants of the Sahara discovered that their relatively green surroundings were undergoing something worse than a drought (and perhaps they migrated towards the Nile Valley, where Egyptian culture began to flourish at around the same time).

“We’re learning, and only in recent years, that some climate changes in the past have been as rapid as anything underway today,” says Robert Giegengack, a University of Pennsylvania geologist.

As the land dried out and vegetation decreased, the soil lost its ability to hold water when it did rain. Fewer clouds

formed from evaporation. When it rained, the water washed away and evaporated quickly. There was a kind of runaway drying effect. By 4,000 years ago the Sahara had become what it is today.

No one knows how human-driven climate change may alter the Sahara in the future. It's something scientists can ponder while sipping bottled fossil water pumped from underground.

"It's the best water in Egypt," Giegengack said — clean, refreshing mineral water. If you want to drink something good, try the ancient buried treasure of the Sahara.

JOEL ACHENBACK

Staff Writer, *Washington Post*

3 Sub-titling

THE purpose of sub-titling is to convey the main idea or theme of each section of a long piece of writing. It helps the reader know at a glance the sub-topics that are being addressed. Giving suitable sub-titles helps break the monotony of reading long passages.

Read the newspaper article given below and do the tasks that follow.

A new deal for old cities

The example of Curitiba in Brazil, which has attracted global attention for innovative urban plans using low-cost technologies, shows that inclusive development models for urban renewal are workable.

Many cities in India accurately mirror Friedrich Engels' description of urban centres in nineteenth century England even today. "Streets that are generally unpaved, rough, dirty, filled with vegetable and animal refuse, without sewers or gutters but supplied with foul, stagnant pools instead," wrote Engels on the living conditions of the working class in that country.

Urban Decay

The depths of urban decay in India came to global notice during the pneumonic plague of 1994 in Surat; it epitomised the failure of governments in the post-Independence era and exposed development policies that

ignored fundamental public health issues inherited from colonial rule. There is little evidence to show that policymakers assimilated the lessons from the Surat public health disaster. State and municipal governments did not pursue reform in waste management, though civic conditions in Surat itself underwent change in the plague aftermath. During the past decade, many cities pursued development agendas—often with the help of massive international loans—to project 'modernisation' at the cost of basic civic reform.

There is thus a continuing challenge before the current mission to enable and also compel local governments to abide by the

provisions of the Municipal Solid Waste Management Rules by which they are legally bound.

Post-liberalisation policies have tended to largely disregard other key factors that affect the quality of life in cities and towns: poverty, lack of sanitation, water shortages, gross undersupply of affordable housing, and traffic chaos generated by automobile dependence, in turn created by neglect of public transport.

In the absence of a hygienic environment and safe water supply, chronic water-borne diseases such as cholera and other communicable diseases continue to stalk the poor in the biggest cities.

It must be sobering to the affluent layers of the population that nearly 14 million Indian households (forming 26 per cent of the total) in the urban areas do not have a latrine within the house, as per the Census of India 2001; some 14 per cent have only rudimentary 'pit' facilities. The number of households without a drainage connection stands at 11.8 million (representing 22.1 per cent of households). Migration to cities continues and infrastructure to treat sewage is grossly inadequate to meet the demand even where it exists.

It is unlikely that the quality of the urban environment can be dramatically improved therefore, if such fundamental questions remain unresolved.

Urban transport receives scant attention from policymakers. Policy distortions have led to rising automobile dependency, higher safety risks for road users, and land use plans that are based not on the needs of people, but primarily designed to facilitate use of private motorised vehicles.

It comes as no surprise therefore that pedestrians and bicycle riders, who form 30 to 70 per cent of peak hour traffic in most urban centres, also make up a large proportion of fatalities in road accidents. A paper prepared by the Transport Research and Injury Prevention Programme (TRIPP) of the Indian Institute of Technology, Delhi, says pedestrian fatalities in Mumbai and Delhi were nearly 78 per cent and 53 per cent of the total, according to recent data, compared to 13 per cent and 12 per cent in Germany and the United States.

Such alarming death rates — and an equally high injury rate — should persuade policymakers to revisit their urban planning strategies and correct the distortions. But many cities such as Chennai have actually done the reverse — reduced footpaths and areas for pedestrian use to facilitate unrestricted use of motorised vehicles.

The practice in progressive world cities has been different. Curitiba in Brazil, which has attracted global attention for innovative urban plans using low-cost technologies, has done everything that Indian policymakers would dread to do. Starting in the 1970s, this provincial centre with the highest per capita ownership of cars in Brazil (other than the capital) at the time, banned automobiles from many crowded areas in favour of pedestrians, built an internationally acknowledged bus system that reduced household commuting expenditure to below the national average, and created new housing areas that were provided transport links in a planned manner. Some of the prestigious land development in the city, including a

new Opera House, came up in abandoned sites such as quarries.

The bus-way system cut riding time by a third, *Scientific American* noted in a review in the mid-1990s, by providing for advance ticketing, specially-designed boarding areas with wider doors for entry/exit and dedicated lanes for faster transit.

In another low-cost initiative, Curitiba managed floods with a dedication that Mumbai, Bangalore, and Chennai can only marvel at. The city created large artificial lakes in suitable places that filled up in the monsoon, avoiding flooding of residential areas. In the summer, these lakes turned into parks to provide recreational spaces.

State administrations and urban planning bodies in India follow

policies that, ironically, allow filling of existing wetlands by real estate lobbies, leading to flooding. The residents then demand expensive new storm water drains.

Examples such as Curitiba show that inclusive development models for urban renewal are workable. If only the state and local governments can be persuaded to adopt a rights-based approach to affordable housing, sanitation, water supply, mobility and a clean environment, instead of a market-oriented model that lays excessive emphasis on recovery of costs incurred by profit-oriented private sector service provision. Support from a progressive middle class and trade unions is equally critical to bring about genuine urban renewal.

G. ANANTHAKRISHNAN

The Hindu, 13 December 2005

Activity

1. Notice the italicised sentence placed at the top of the article which tells us at a glance what the article is about.
2. Divide the article into four sections based on the shifts in the sub-topics and give a suitable sub-heading for each section. One has been done for you in the article as an example.
3. Look for pictures in newspapers and magazines that depict the urban civic problems discussed in the text. Cut them out and pin them to the text at appropriate places.

4 Essay-writing

Most of us find it difficult to begin writing. We can make this easier by thinking about the topic either through brainstorming, that is with several people in a group giving their ideas as they strike them, or by putting them down on a sheet of paper as they occur to us.

For example, if the topic is 'Hobbies', we can draw a circle and write 'hobbies' in it:



Then we can put down our thoughts as they come to us in a random manner as shown below.

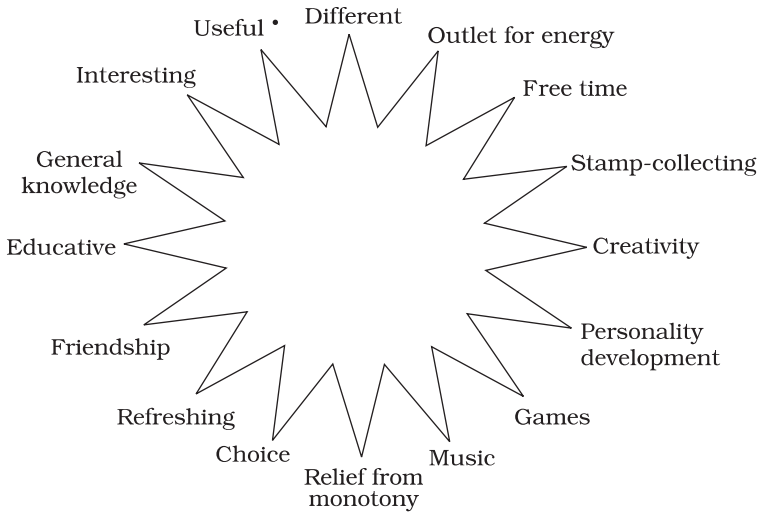

Having done that we select the points and expand each into a sentence.

1. Hobbies are free-time activities. Examples are stamp-collecting, painting etc.
2. They are matters of personal choice, not forced.
3. They are interesting and give pleasure.
4. They refresh the mind by providing an opportunity to do different kinds of activities.
5. They provide relief from monotony.
6. They help us channelise our energy.
7. They can also be useful activities and can provide pleasure to others. For example, reading out to visually impaired people, visiting art exhibitions, music concerts etc.
8. Hobbies are educative and they widen our general knowledge.
9. They help us develop our overall personality.
10. They serve as a medium for the expression of our creativity.
11. We meet interesting people through our common interests and develop friendships.

We usually begin a topic with a definition or short description. We could begin thus:

Hobbies are activities that we engage in, in our free time. We may be interested in needlework, drawing and painting or music. Other common hobbies are stamp-collecting, clay-modelling, solving crossword puzzles.

Although hobbies also entail work they are taken upon through one's own personal choice. They are not forced upon us. They are activities that we are really interested in and hence give us a great deal of pleasure.

Hobbies make life interesting. They refresh our minds after a hard day's work. We need to do something different in order to do our routine work effectively. Hobbies provide this variety.

Hobbies relieve us from the monotony of daily life. They fill us with enthusiasm for work and keep our energy levels high. We will go to any extent to get the things that we require, to get the utmost joy from our hobbies.

Hobbies are also useful activities. Quite a few hobbies, like stamp-collecting, widen our general knowledge about various countries of the world. When we share common interests we even get into correspondence with people of other countries.

This is how we write an essay.

A composition on a particular subject consisting of more than one paragraph is an essay. The characteristics of a good essay are:

- Unity** : *The essay should deal with the main subject, and all parts of it should be clearly linked with that subject.*
- Coherence** : *There should be a logical sequence of thought. This requires a logical relationship between ideas, sentences and paragraphs.*
- Relevance** : *Unimportant information should not be included.*
- Proportion** : *Giving more space to the important ideas.*

Read the following essay and the passage analysis that follows it carefully.

The Importance of Games

1. "The Battle of Waterloo was won on the playing fields of Eton." These words have been attributed to the Duke of Wellington. Certainly one does not play games in order to win battles; neither does the curriculum include them for that reason. But the importance of games in life should not be underestimated, for without them it is harder for a person to be sound in body and mind.
2. For one thing, if a person is to fulfil all the duties that society expects of him, it is important for him to keep healthy. He may be very intelligent, but that has little meaning if he cannot make use of his intelligence, because he is always suffering from bad health. In some ways, the human body is like a machine. If it is not made use of, it starts to work badly. People who are not fit grow weak and become more susceptible to disease. Any form of game is useful, provided it gives the body an opportunity to take regular physical exercise.

3. Secondly, playing — and therefore experiencing winning and losing — encourages the spirit of sportsmanship, thus enabling one to deal with life's problems in a wise and natural manner. Games teach the truth embodied in the Olympic motto: 'The important thing in playing is not the winning or the losing, but the participation' — and, I may add, doing the best one can.
4. We have to remember some other things about playing games, however. First, it is the physical exercise that is important for health, not the games themselves, and there are other ways of getting this. Is not India the home of yoga? It is also possible to be too interested in games. When we think of the Greek ideal expressed in the Latin phrase, 'mens sana in corpore sano' (a healthy mind in a healthy body), we should not forget that it is the mind which is mentioned first. And if we let games become the most important thing in our lives, we may be in danger of changing the Olympic motto to 'the important thing is winning'.
5. Nevertheless, in spite of these dangers, playing games can be a valuable activity, and if we take part in them wisely, we can gain great benefits.

Passage Analysis

- The writer uses five paragraphs
- Each paragraph deals sequentially with a topic.
 - Paragraph 1 introduces the subject, and makes a general statement about the importance of games.
 - Paragraph 2 explains the benefits of playing games.
 - Paragraph 3 deals with the moral benefits.
 - Paragraph 4 deals with the disadvantages and dangers.
 - Paragraph 5 sums up the writer's opinion, taking into account all he has said in paragraphs 2, 3 and 4, i.e. it forms the conclusion. The structure (or plan) of the essay is summed up in the following flow diagram.

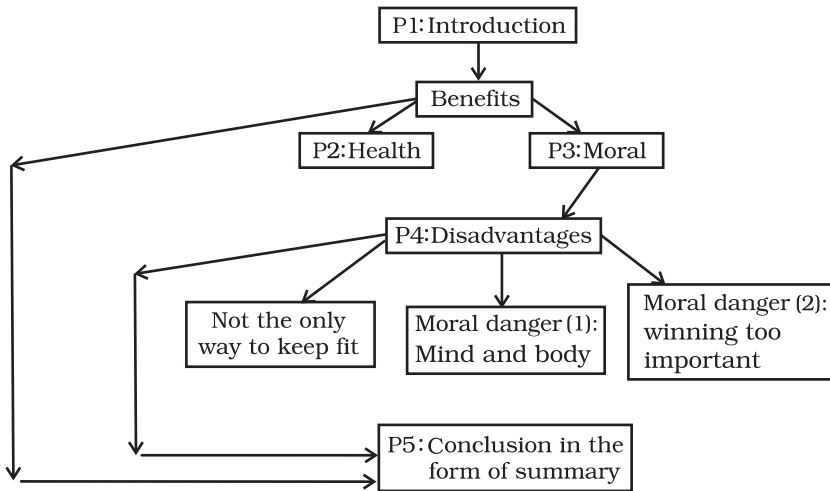

Activity

Here are a few topics for essay writing. Follow the steps listed above to write on these topics.

1. Himalayan quake 2005.
2. Those who can bear all can dare all.
3. Fascinating facts about water.
4. Public health in transition.
5. Human population grows up.
6. Success begins in the mind.
7. Think before you shop.

The trend of decline in the Child Sex Ratio (CSR) defined as number of girls per 1000 boys between 0-6 years of age, has remained unabated till today. To ensure survival, protection and empowerment of the girl child, the Government has announced Beti Bachao Beti Padhao initiative. This is being implemented through a national campaign. The objectives of these initiatives are:

- Prevention of gender-biased sex selection elimination.
- Ensuring survival and protection of the girl child.
- Ensuring education and participation of the girl child.

Organise essay writing activity in your class, the themes should be based on the objectives stated above. Mention how you can contribute in this programme, in the essay.

5 Letter-writing

LETTER-WRITING is an important channel of communication between people who are geographically distant from one another. In earlier times when the telephone and e-mail were not available, the only means of communication between people was through letters.

Letter-writing is a skill that has to be developed. In general there are two types of letters: formal, that are written to convey official business and information and informal, which are personal letters to communicate with friends and family. Formal letters are sent out when we need to write to various public bodies or agencies for our requirements in civic life. For example, we might have to ask for a certificate or to inform a change in our address. A letter is usually one in a series of exchanges between two people or parties.

Formal Letters

Let us now examine some of the steps in writing formal letters.

1. (i) *Introducing oneself if it is the first time you are writing*
(ii) *Referring to an earlier letter if you are responding to it.*
2. *Stating the purpose of the letter*
3. (i) *Stating action/information required from the addressee*
(ii) *Explaining action taken/supplying information*
4. (i) *Urging action to be taken*
(ii) *Offering assistance in future*

This is the basic structure of a letter. It will have to be modified according to the purpose for which it is written and the person to whom it is addressed.

When you write a letter you should keep in mind the following points.

1. *Purpose*
2. *Person to whom it is addressed*
3. *Tone you should adopt*
4. *Completeness of the message*
5. *Action required*
6. *Conciseness of expression*

We have so far considered the content of letters. A letter also has a typical format.

1. *Name and address of sender*

Companies have printed letterheads with the name of the company printed on them. A letterhead may also carry the name and designation of persons in responsible positions.

2. *Name and address of addressee*
3. *Date*
4. *Mode of address or salutation*

Salutation is the mode of addressing a person. We may have the following forms.

- (i) Dear Sir/Madam (when we are writing to a total stranger whom we do not know at all).
- (ii) Dear Mr/Ms/Dr/Professor + Surname as in: Dear Dr Sinha, (when it is a formal relationship with the addressee and the writer does not know him or her personally).
- (iii) Dear Sujata (when the writer knows the addressee personally and the two share a semi-formal relationship).

5. *Reference to previous correspondence, if any.*

Most official letters carry a subject line just above the salutation. This is for quick reference to the subject.

6. *Content of letter*

The content of the letter begins on the next line and is arranged in two or three paragraphs.

7. *Complimentary close and signature*

Letters usually end politely with the following phrases:
Thank you, With regards, With best wishes, Hope to see

you soon, Hope to receive an early reply etc. The complimentary close is followed by 'Yours sincerely/ Yours truly', and the writer's signature in the next line.

Given below is an example of the format of a formal letter.

Ritu Patel
Manager, Customer Services
Vijayanagar Gas Company
121, Ameerpet
Hyderabad 500 016

12 November 2005

Mr Shagun Thomas
801, Vijay Apartments
Begumpet
Hyderabad 500 016

Sub: Your application No. F323 for a new gas connection

Dear Mr Thomas,

With regards,
Yours sincerely,
Ritu Patel

Nowadays all the parts of a letter are aligned on the left. This style is called the Full-Block style.

- The date and signature are very important in letters.
- We do not use commas after every line in the address.

- Do not begin your letters with hackneyed expressions like, 'With reference to your letter dated 10 January'. Instead, use personalised variations like, 'I was glad to receive your letter of 10 January...' or 'We were happy to note from your letter that the goods have reached you safely...'
- Never end your letters with hanging participles like 'Thanking you' or 'Awaiting your reply'. Instead write, 'Thank you' or 'We/I await/look forward to your reply'.

Informal Letters

Informal letters include personal letters. If it is a personal letter the format is flexible. We might just write the name of our city on top, followed by the date.

Hyderabad
12 November 2005

Dear Sujata,

Bye,

Yours affectionately/With love/
All the best/Take care etc.

(Signature)

The flexible format of the informal letter may also be used to seek information from concerned authorities. Given below is an example.

179 NCERT Campus
Sri Aurobindo Marg
New Delhi 110 016

9 September 2005

The Manager
Himachal Tourism
Mall Road
Shimla

Dear Sir,

We are planning to spend our vacation in Dharamsala, Himachal Pradesh during Dussehra and would like some information regarding availability of lodging in the area.

We would like to have information about inexpensive hotels in and around Dharamsala. Could you please send me a city map and brochures about the activities and sights in the city?

Thank you.

Yours faithfully,

(Suryadhan Kumar)

Given below is the format of the informal letter.

- *Your address (but not your name) usually goes in the top right-hand corner, but may go on the left too.*
- *The name and/or job title (if you know them) and the address of the person you are writing to goes on the left.*

- To address someone whose name you do not know you can write: *Dear Sir, Dear Madam, Dear Sirs, Dear Sir/Madam.*
- To address someone by name, use their title and surname e.g. *Dear Dr Balakrishnan.*
- To end a letter, use *'Yours sincerely'*, if you have addressed the person by name; *'Yours faithfully'*, if you have begun the letter with *'Dear Sir'* or *'Madam'*, etc.

Job Application

At some point of time each one of us will have to apply for a job. Job applications are usually written in response to advertisements.

Let us take this sample advertisement from a daily newspaper, *The Hindu* dated 15 November 2005.

Come...join the ADVENTURE
Customer Support Executives
Graduate/Diploma holders
with/without experience
possessing good Customer
Service skills. Excellent spoken
and written communication
skills in English is a must.
*Send in your applications with
your resume and passport
size photograph to:*
WONDERLAND
COMMUNICATIONS,
SOUTH STREET, SALEM,
TAMIL NADU

Let us assume that you have a degree or a diploma and are applying for the job. We need to prepare a resume, which actually means a summary of particulars relating to your background, academic qualifications and experience, if any. Other terms used for 'resume' are 'curriculum vitae' and 'biodata'.

The general format of a resume or curriculum vitae is shown below.

CURRICULUM VITAE

Name :

Address :

Telephone Number :

E-mail ID :

Date of birth :

Academic Qualifications :

Examination	Board/ University	Subjects	Year	Division
S.S.C				
Diploma in...				
Degree in...				

Experience : (Begin from present employment)

Skills :

Languages known :

Hobbies and Interests :

Achievements :

References : (names of people in positions like your school Principal who can certify your character and conduct)

Now we need to send a covering letter along with the curriculum vitae. The following letter is an example.

Your name and address

Date

The Manager

Human Resource Division

Wonderland Communications

South Street, Salem

Tamil Nadu

Dear Sir,

I would like to apply for the post of Customer Support Executive that you have advertised in *The Hindu* of 15 November 2005.

I have just completed my Diploma in Communication from the State Polytechnic. I was happy to note that you do not insist on experience.

If selected, this would be my first job. I am a sincere, honest and hardworking person. I am friendly and outgoing and have good communication skills.

I am enclosing my resume and look forward to meeting you in person.

Regards,

Yours truly,

(Signature)

Activities

1. You have not received your Roll Number card for the Class XII examination. Write a letter to the Registrar, Examination Branch, CBSE asking for it.

2. Write a letter to the President, Residents' Welfare Association of your locality suggesting some measures that could be taken for solving the problem of water scarcity and conserving water.
3. Write a letter to the editor of a newspaper expressing your views on the deteriorating law and order situation in your city.
4. Write a letter to your friend narrating your experiences in a rescue operation.
5. Write a letter to the Editor of a magazine describing a dance performance you have seen or an art gallery you have visited.

6 Creative Writing

THE teacher was explaining the lines in the beginning of Shakespeare's play *Macbeth*. It was a description of the battle and the lines were:

Like Valour's minion, carved out his passage,
Till he faced the slave;
With ne'er shook hands, nor baded farewell to him.
Till he **unseam'd** him from the nave to the chaps,...

The teacher asked the students what the word 'unseamed' meant. It was difficult. The teacher prodded them on. "What does 'seam' mean? Haven't you ever come across the word?" One of the students blurted out "Cricket ball".

This is an example of how each of us reacts to words according to what our own experience has been.

When we write about factual information, all of us write almost similarly. But when we write for pleasure each of us may write about the same event in different ways.

One very important element in creative writing is imagination. This is reflected in

- our view or perspective
- choice of words
- the comparisons we make
- the images we use
- the tone we adopt
- novelty of ideas.

Let us study the paragraph below.

A town is like an animal. A town has a nervous system and a head and shoulders and feet. A town is a thing separate from all other towns, so that there are no towns alike. And a town has a whole emotion. How news travels through a town

is a mystery not easily to be solved. News seems to move faster than small boys can scramble and dart to tell it, faster than women can call it over the fences. (from an adapted version of Steinbeck's *The Pearl*)

The topic: A Town

Analogy or comparison: to an animal

Word choice: "has a whole emotion."

Comparisons: "faster than small boys can scramble and dart, faster than women...."

We find the first element of imagination operating in the way the writer visualises the town. Then he extends the primary analogy. The tone he adopts is light humour, a little sarcastic.

When we begin to write a story or poem we let our imagination free. We try to say things in a new way. This novelty is what makes our writing pleasurable to the reader.

Sometimes sentence structures are also different from factual writing. Consider the following:

They waited in their chairs until the pearls came in, **and then they cackled and fought and shouted and threatened** until they reached the lowest price the fisherman would stand. (from *The Pearl*).

In a normal construction we will not use so many 'ands'. But the action of the story is best reflected through this kind of chaining of actions through 'ands'. It is appropriate to the movement of the action described.

Let us look at another example:

She dragged me after her into Miss Rachel's sitting-room, which opened to her bedroom. At her bedroom door stood Miss Rachel, **her face almost white as the white dressing-gown she wore.**

The author has used a simile: "white as the white dressing-gown she wore."

In fact, the whiteness of a human face is because of a strong emotion — fear or shock.

But here comparing the whiteness to the dressing-gown she wore serves to **exaggerate** and intensify the emotion.

Exaggeration is one of the ways in which fact is distinguished from fiction.

Now look at these lines from a well-known poem, 'An Elegy Written in a Country Churchyard' by Thomas Gray.

Full many a gem of purest ray serene
The dark unfathom'd caves of ocean bear
Full many a flower is born to blush unseen
And waste its fragrance in the desert air.

The stanza carries a simple statement: many people with outstanding qualities live and die unnoticed by the world.

To state this, the poet has used two strong images, 'a gem' and 'a flower'.

He has used two contrasting places: the ocean, that is full of water and the desert with no water at all.

Also notice the rhyming words: 'serene' and 'unseen', 'bear' and 'air'.

The first and third lines also begin with the same words — "full many a". The lines are of equal length.

All this together contribute to the literary quality of these lines.

Activity I

Put down the images that come to your mind immediately when you see the words in the box.

cat	cupboard	wall	pond	bird
-----	----------	------	------	------

Activity II

Try to write four lines of poetry or four sentences of prose with one of these as the starting point.

Activity III

Write a short story beginning with this sentence:

When the last of the guests left, I went back into the hall....

Activity IV

Look for a story, a poem and a newspaper article on environment conservation and see how the style of each is different from the other.